

Round Type, FULL COLOR LED lamp
BL-L515
Features:

- Ø 5mm Round Type , FULL COLOR LED lamp
- Ø Ultra brightness.
- Ø Choice of various viewing angles.
- Ø Diffused, Transparent and Water clear lens
- Ø IC compatible /Low current capability.
- Ø RoHs Compliance

Electrical-optical characteristics: (Ta=25°C) (Test Condition: IF=20mA)

Part Number	Chip			Lens Type	Forward Voltage(VF) Unit:V		Luminous Intensity (lv) Unit:mcd		Viewing Angle 2θ/2 (deg)
	Emitted Color	Material	λ _P (nm)		Typ	Max	Min.	Typ.	
					BL-L515RGBC-CA	Ultra Orange	AlGaInP	630	
	Ultra Pure Green	InGaN	525		3.80	4.50	2000	5000	
	Blue	InGaN	430		3.80	4.50	800	2000	
BL-L515RGBW-CA	Ultra Orange	AlGaInP	630	Water Diff.	2.10	2.50	200	500	30
	Ultra Pure Green	InGaN	525		3.80	4.50	300	600	
	Blue	InGaN	430		3.80	4.50	150	300	
BL-L515RGBC-CC	Ultra Orange	AlGaInP	630	Water Clear	2.10	2.50	800	2000	20
	Ultra Pure Green	InGaN	525		3.80	4.50	2000	5000	
	Blue	InGaN	430		3.80	4.50	800	2000	
BL-L515RGBW-CC	Ultra Orange	AlGaInP	630	Water Diff.	2.10	2.50	200	500	30
	Ultra Pure Green	InGaN	525		3.80	4.50	300	600	
	Blue	InGaN	430		3.80	4.50	150	300	

Note: -CC: common Cathode, -CA: common Anode

Absolute maximum ratings (Ta=25°C)

Parameter	UE	PG	UB	Unit
Forward Current I _F	30	30	30	mA
Power Dissipation P _d	65	110	120	mW
Reverse Voltage V _R	5	5	5	V
Peak Forward Current I _{PF} (Duty 1/10 @1KHZ)	150	150	100	mA
Operation Temperature T _{OPR}	-40 to +80			°C
Storage Temperature T _{STG}	-40 to +85			°C
Lead Soldering Temperature T _{SOL}	Max.260±5°C for 3 sec Max. (1.6mm from the base of the epoxy bulb)			°C

Round Type, FULL COLOR LED lamp

BL-L515

Package configuration & Internal circuit diagram

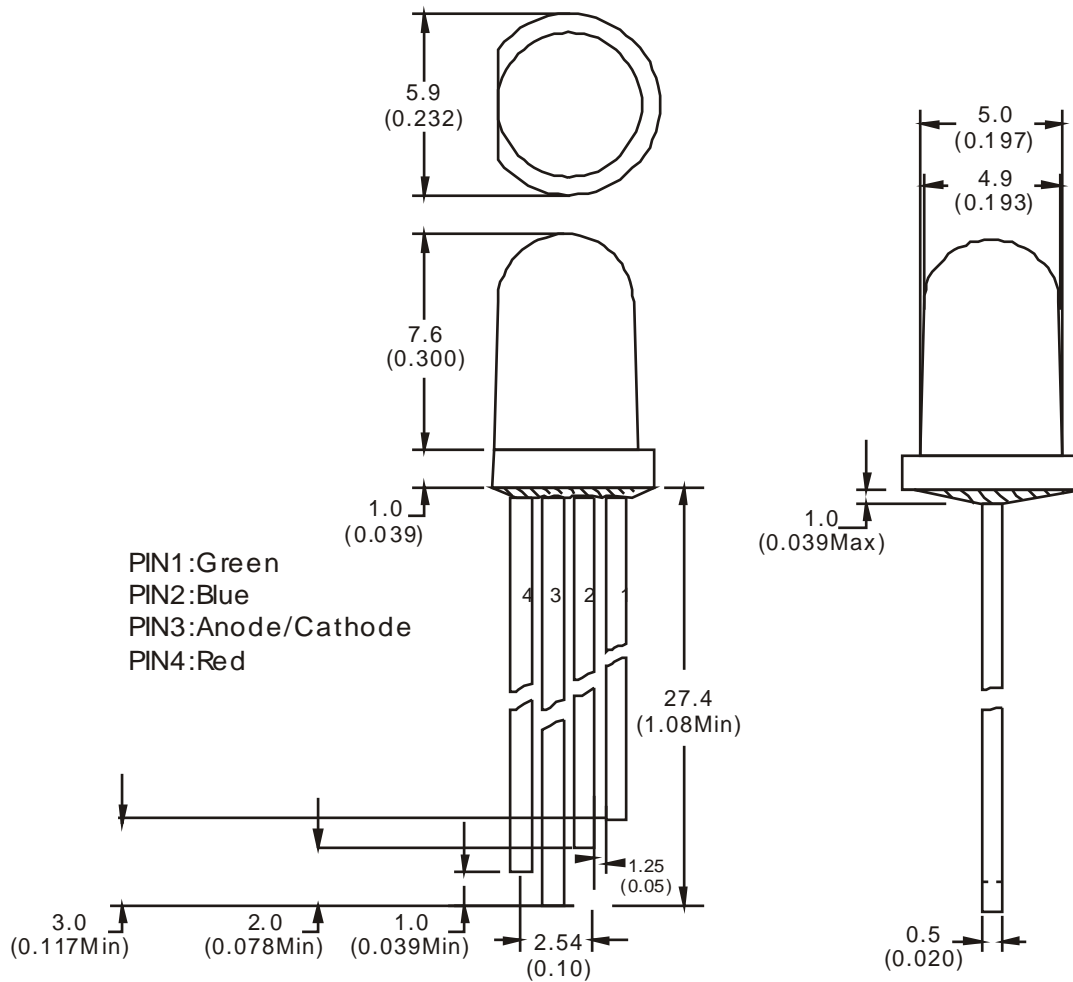

Notes:

1. All dimensions are in millimeters (inches)
2. Tolerance is ± 0.25 (0.01") unless otherwise noted.
3. Specifications are subject to change without notice.

Round Type, FULL COLOR LED lamp

BL-L515

Typical electrical-optical characteristics curves:

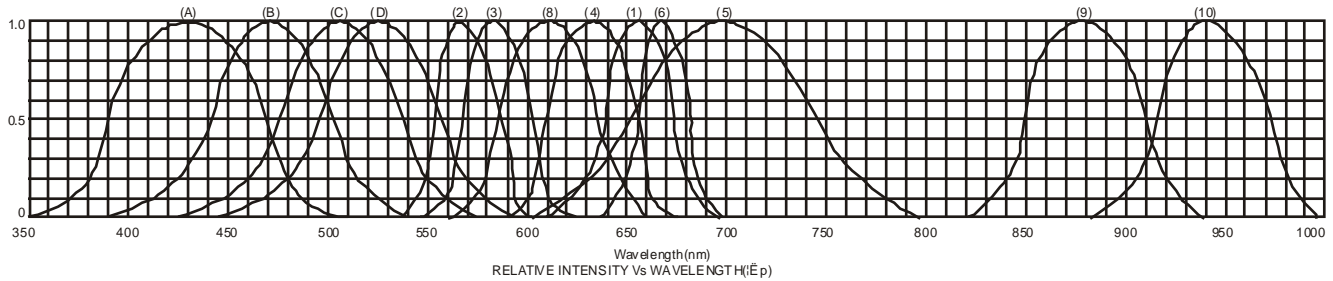

- (1) - GaAsP/GaAs 655nm/Red
- (2) - GaP 570nm/Yellow Green
- (3) - GaAsP/GaP 585nm/Yellow
- (4) - GaAsP/GaP 635nm/Orange & Hi-Eff Red
- (5) - GaP 700nm/Bright Red
- (6) - GaAlAs/GaAs 660nm/Super Red
- (8) - GaAsP/GaP 610nm/Super Red
- (9) - GaAlAs 880nm
- (10) - GaAs/GaAs & GaAlAs/GaAs 940nm
- (A) - GaN/SiC 430nm/Blue
- (B) - InGaN/SiC 470nm/Blue
- (C) - InGaN/SiC 505nm/Ultra Green
- (D) - InGaAlSiC 525nm/Ultra Green

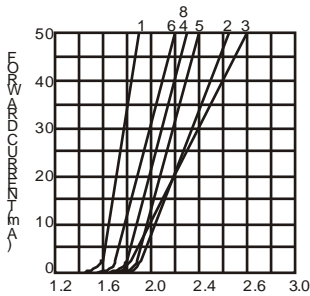

FORWARD VOLTAGE (Vf)
FORWARD CURRENT VS.
FORWARD VOLTAGE

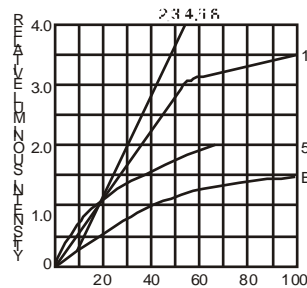

FORWARD CURRENT (mA)
RELATIVE LUMINOUS
INTENSITY VS. FORWARD
CURRENT

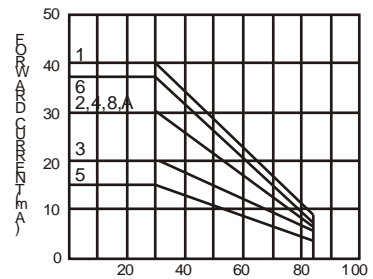

AMBIENT TEMPERATURE Ta ()
FORWARD CURRENT VS. AMBIENT
TEMPERATURE



AMBIENT TEMPERATURE Ta ()

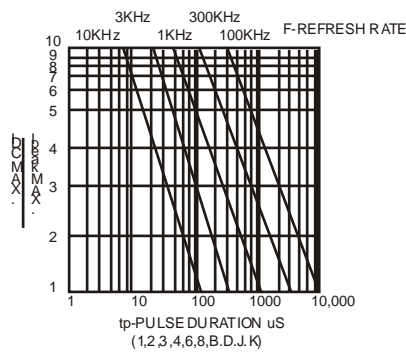

tp-PULSE DURATION μ s
(1,2,3,4,6,8,B,D,J,K)

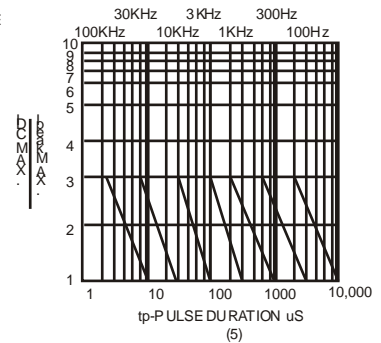

(5)

NOTE:25 free air temperature unless otherwise specified

Mouser Electronics

Authorized Distributor

Click to View Pricing, Inventory, Delivery & Lifecycle Information:

[Adafruit:](#)

[159](#)