

LEGEND  = KEY PRODUCT CHARACTERISTICS

REVISION HISTORY				
REV	DESCRIPTION	BY	DATE	CHG No
0	FIRST ISSUED	MH	18-09-14	----

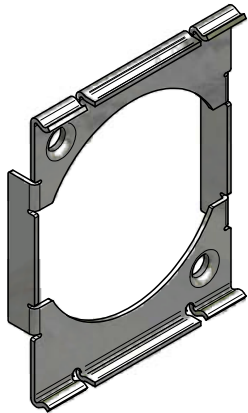

3D VIEW

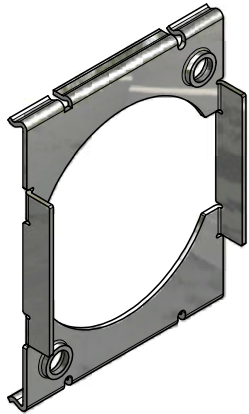
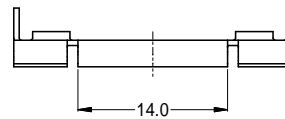
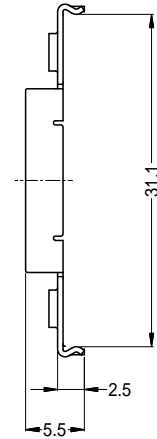
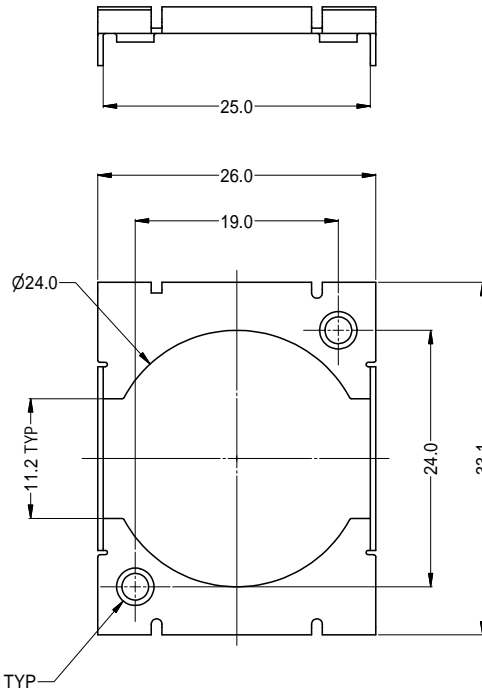
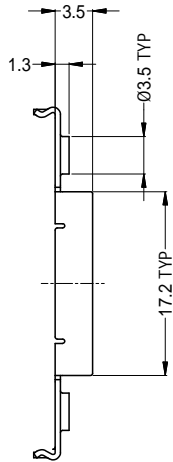

- NOTES:
1. MATERIAL: 0.5MM THICK SPRING STEEL.
 2. FINISH: MIN 2um NICKEL PLATED.
 3. ALL MATERIAL SHALL BE RoHS COMPLIANT.

UNLESS OTHERWISE SPECIFIED TOLERANCE TO BE		THIS DOCUMENT IS THE PROPERTY OF AMPHENOL AUSTRALIA PTY. LTD. NO PART THEREOF MAY BE REPRODUCED AND USED WITHOUT THE PRIOR WRITTEN CONSENT OF THE OWNER			Amphenol Amphenol Australia Pty.Ltd, 22 Industry Blvd, Carrum Downs, VIC 3201	
LINEAR	ANGULAR	MATERIAL:	DRN:	DATE:	TITLE:	PART No:
X ±0.5 X.X ±0.25 X.XX ±0.1	X' ±1 X.X' ±30 X.XX' ±15	0.5mm THICK SPRING STEEL	MH	18-09-14	M3x0.5mm THREAD REAR PANEL CLIP CUSTOMER DRAWING	52590060-300
BREAK ALL SHARP EDGES AND REMOVE ALL BURRS		FINISH: NICKEL PLATED	CKD:	DATE:	DRAWING NO.	
DO NOT SCALE		APP'D:	PM	18-09-14	SHEET	
DIMENSIONS IN MILLIMETRES		SCALE: 2:1	SIZE: A3	CAD FILE: 52590060300110	52590060-300-1 2/2	

Mouser Electronics

Authorized Distributor

Click to View Pricing, Inventory, Delivery & Lifecycle Information:

[Amphenol:](#)

[52590060-300](#)