

FEATURES

Single positive supply (self biased)
High OIP2: 52 dBm typical at 0.6 GHz to 7.5 GHz
High gain: 15 dB typical at 0.6 GHz to 6 GHz
High OIP3: 32 dBm typical
Low noise figure: 3.5 dB typical at 0.4 GHz to 6 GHz
RoHS-compliant, 3 mm × 3 mm, 16-lead LFCSP

APPLICATIONS

Test instrumentation
Military communications

GENERAL DESCRIPTION

The ADL8104 is a gallium arsenide (GaAs), monolithic microwave integrated circuit (MMIC), pseudomorphic high electron mobility transistor (pHEMT), low noise, wideband, high linearity amplifier that operates from 0.4 GHz to 7.5 GHz.

The ADL8104 provides a typical gain of 15 dB at 0.6 GHz to 6 GHz, a 3.5 dB typical noise figure at 0.4 GHz to 6 GHz, a 20 dBm typical output power for 1 dB compression (OP1dB) at 0.6 GHz to 6 GHz, and a typical output third-order intercept (OIP3) of 32 dBm at 0.6 GHz to 6 GHz, requiring only 150 mA from a 5 V drain supply voltage. The low noise amplifier has a

FUNCTIONAL BLOCK DIAGRAM

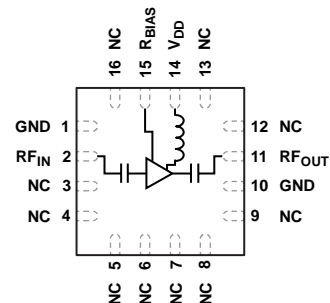

Figure 1.

23884-001

high output second-order intercept (OIP2) of 52 dBm typical at 0.6 GHz to 6 GHz, making the ADL8104 suitable for military and test instrumentation applications.

The ADL8104 also features inputs and outputs that are internally matched to 50 Ω. The RF_{IN} and RF_{OUT} pins are internally ac-coupled and the bias inductor is also integrated, making the ADL8104 ideal for surface-mounted technology (SMT)-based, high density applications.

The ADL8104 is housed in an **RoHS-compliant, 3 mm × 3 mm, 16-lead LFCSP**.

TABLE OF CONTENTS

Features	1	Electrostatic Discharge (ESD) Ratings.....	5
Applications	1	ESD Caution	5
Functional Block Diagram	1	Pin Configuration and Function Descriptions	6
General Description	1	Interface Schematics	6
Revision History	2	Typical Performance Characteristics	7
Specifications	3	Theory of Operation	21
0.4 GHz to 0.6 GHz Frequency Range	3	Applications Information	22
0.6 GHz to 6 GHz Frequency Range	3	Recommended Bias Sequencing	22
6 GHz to 7.5 GHz Frequency Range	3	Outline Dimensions.....	23
DC Specifications	4	Ordering Guide	23
Absolute Maximum Ratings	5		
Thermal Resistance	5		

REVISION HISTORY

9/2020—Revision 0: Initial Version

SPECIFICATIONS

0.4 GHz TO 0.6 GHz FREQUENCY RANGE

$V_{DD} = 5\text{ V}$, total supply current (I_{DQ}) = 150 mA, $R_{BIAS} = 90.9\ \Omega$, and $T_A = 25^\circ\text{C}$, unless otherwise noted.

Table 1.

Parameter	Min	Typ	Max	Unit	Test Conditions/Comments
FREQUENCY RANGE	0.4		0.6	GHz	
GAIN	11.5	14		dB	
Gain Variation over Temperature		0.036		dB/ $^\circ\text{C}$	
NOISE FIGURE		3.5		dB	
RETURN LOSS					
Input		12		dB	
Output		13		dB	
OUTPUT					
OP1dB	16.5	19		dBm	
Saturated Output Power (P_{SAT})		21		dBm	
OIP3		32		dBm	Measurement taken at output power (P_{OUT}) per tone = 5 dBm
OIP2		50		dBm	Measurement taken at P_{OUT} per tone = 5 dBm
POWER ADDED EFFICIENCY (PAE)		18		%	Measured at P_{SAT}

0.6 GHz TO 6 GHz FREQUENCY RANGE

$V_{DD} = 5\text{ V}$, $I_{DQ} = 150\text{ mA}$, $R_{BIAS} = 90.9\ \Omega$, and $T_A = 25^\circ\text{C}$, unless otherwise noted.

Table 2.

Parameter	Min	Typ	Max	Unit	Test Conditions/Comments
FREQUENCY RANGE	0.6		6	GHz	
GAIN	12	15		dB	
Gain Variation over Temperature		0.030		dB/ $^\circ\text{C}$	
NOISE FIGURE		3.5		dB	
RETURN LOSS					
Input		12		dB	
Output		12		dB	
OUTPUT					
OP1dB	17.5	20		dBm	
P_{SAT}		21		dBm	
OIP3		32		dBm	Measurement taken at P_{OUT} per tone = 5 dBm
OIP2		52		dBm	Measurement taken at P_{OUT} per tone = 5 dBm
PAE		12		%	Measured at P_{SAT}

6 GHz TO 7.5 GHz FREQUENCY RANGE

$V_{DD} = 5\text{ V}$, $I_{DQ} = 150\text{ mA}$, $R_{BIAS} = 90.9\ \Omega$, and $T_A = 25^\circ\text{C}$, unless otherwise noted.

Table 3.

Parameter	Min	Typ	Max	Unit	Test Conditions/Comments
FREQUENCY RANGE	6		7.5	GHz	
GAIN	10	13		dB	
Gain Variation over Temperature		0.041		dB/ $^\circ\text{C}$	
NOISE FIGURE		4.5		dB	
RETURN LOSS					
Input		12		dB	
Output		12		dB	

Parameter	Min	Typ	Max	Unit	Test Conditions/Comments
OUTPUT					
OP1dB	15.5	18		dBm	
P _{SAT}		19		dBm	
OIP3		32		dBm	Measurement taken at P _{OUT} per tone = 5 dBm
OIP2		52		dBm	Measurement taken at P _{OUT} per tone = 5 dBm
PAE		12		%	Measured at P _{SAT}

DC SPECIFICATIONS

Table 4.

Parameter	Min	Typ	Max	Unit
SUPPLY CURRENT				
I _{DQ}		150		mA
Drain Current (I _{DD})		144		mA
R _{BIAS} Current (I _{RBIAS})		6		mA
SUPPLY VOLTAGE				
V _{DD}	3	5	5.5	V

ABSOLUTE MAXIMUM RATINGS

Table 5.

Parameter	Rating
V _{DD}	6 V
RF Input Power	25 dBm
Continuous Power Dissipation (P _{DISS}), T _A = 85°C (Derate 22.57 mW/°C Above 85°C)	2.03 W
Temperature	
Storage Range	–65°C to +150°C
Operating Range	–40°C to +85°C
Peak Reflow (Moisture Sensitivity Level 3 (MSL3)) ¹	260°C
Junction to Maintain 1,000,000 Hours Mean Time to Failure (MTTF)	175°C
Nominal Junction (T _A = 85°C, V _{DD} = 5 V, I _{DQ} = 150 mA)	118.22°C

¹ See the Ordering Guide for more information.

Stresses at or above those listed under Absolute Maximum Ratings may cause permanent damage to the product. This is a stress rating only; functional operation of the product at these or any other conditions above those indicated in the operational section of this specification is not implied. Operation beyond the maximum operating conditions for extended periods may affect product reliability.

THERMAL RESISTANCE

Thermal performance is directly linked to printed circuit board (PCB) design and operating environment. Close attention to PCB thermal design is required.

θ_{JC} is the junction to case thermal resistance.

Table 6. Thermal Resistance

Package Type	θ_{JC}	Unit
CP-16-35	44.3	°C/W

ELECTROSTATIC DISCHARGE (ESD) RATINGS

The following ESD information is provided for handling of ESD-sensitive devices in an ESD protected area only.

Human body model (HBM) per ANSI/ESDA/JEDEC JS-001.

ESD Ratings for ADL8104

Table 7. ADL8104, 16-Lead LFCSP

ESD Model	Withstand Threshold (V)	Class
HBM	±500	1B

ESD CAUTION



ESD (electrostatic discharge) sensitive device. Charged devices and circuit boards can discharge without detection. Although this product features patented or proprietary protection circuitry, damage may occur on devices subjected to high energy ESD. Therefore, proper ESD precautions should be taken to avoid performance degradation or loss of functionality.

PIN CONFIGURATION AND FUNCTION DESCRIPTIONS

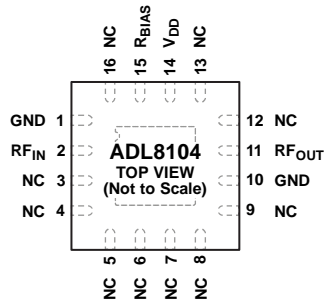

- NOTES**
1. NO CONNECT. THESE PINS ARE NOT CONNECTED INTERNALLY. THESE PINS MUST BE CONNECTED TO THE RF AND DC GROUND.
 2. EXPOSED PAD. THE EXPOSED PAD MUST BE CONNECTED TO THE RF AND DC GROUND.

23884-002

Figure 2. Pin Configuration

Table 8. Pin Function Descriptions

Pin No.	Mnemonic	Description
1, 10	GND	Ground. The GND pin must be connected to the RF and dc ground. See Figure 6 for the interface schematic.
2	RF _{IN}	RF Input. The RF _{IN} pin is ac-coupled and matched to 50 Ω. See Figure 4 for the interface schematic.
3 to 9, 12, 13, 16	NC	No Connect. These pins are not connected internally. These pins must be connected to the RF and dc ground.
11	RF _{OUT}	RF Output. The RF _{OUT} pin is ac-coupled and matched to 50 Ω. See Figure 5 for the interface schematic.
14	V _{DD}	Drain Supply Voltage for the Amplifier. See Figure 5 for the interface schematic.
15	R _{BIAS}	Current Mirror Bias Resistor. Use the R _{BIAS} pin to set the quiescent current by connecting an external bias resistor as defined in Table 9. Refer to Figure 87 for the bias resistor connection. See Figure 3 for the interface schematic.
	EPAD	Exposed Pad. The exposed pad must be connected to the RF and dc ground.

INTERFACE SCHEMATICS

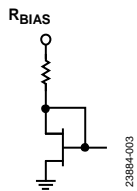

Figure 3. R_{BIAS} Interface Schematic

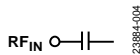

Figure 4. RF_{IN} Interface Schematic

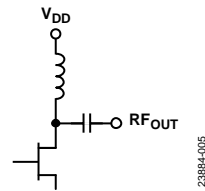

Figure 5. V_{DD} and RF_{OUT} Interface Schematic



Figure 6. GND Interface Schematic

TYPICAL PERFORMANCE CHARACTERISTICS

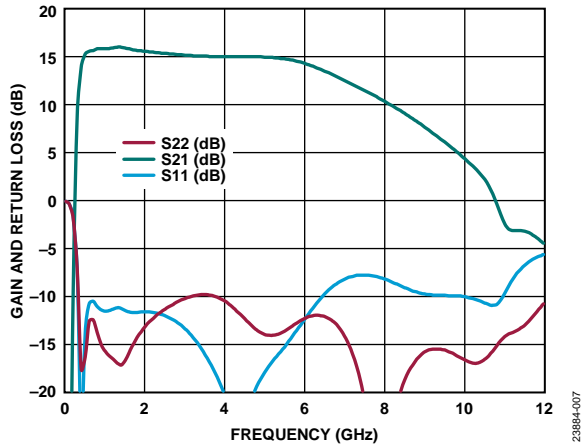

Figure 7. Gain and Return Loss vs. Frequency, 0.01 GHz to 12 GHz, $V_{DD} = 5 V$, $I_{DQ} = 150 mA$, $R_{BIAS} = 90.9 \Omega$ (S22 Is the Output Return Loss, S21 Is the Input Return Loss, and S11 Is the Gain)

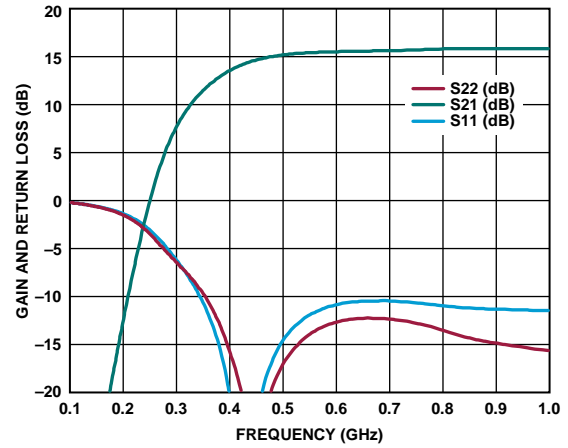

Figure 10. Gain and Return Loss vs. Frequency, 0.1 GHz to 1 GHz, $V_{DD} = 5 V$, $I_{DQ} = 150 mA$, $R_{BIAS} = 90.9 \Omega$

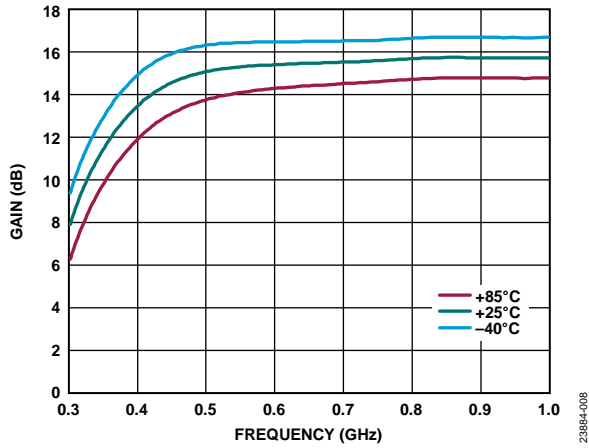

Figure 8. Gain vs. Frequency for Various Temperatures, 0.3 GHz to 1 GHz, $V_{DD} = 5 V$, $I_{DQ} = 150 mA$, $R_{BIAS} = 90.9 \Omega$

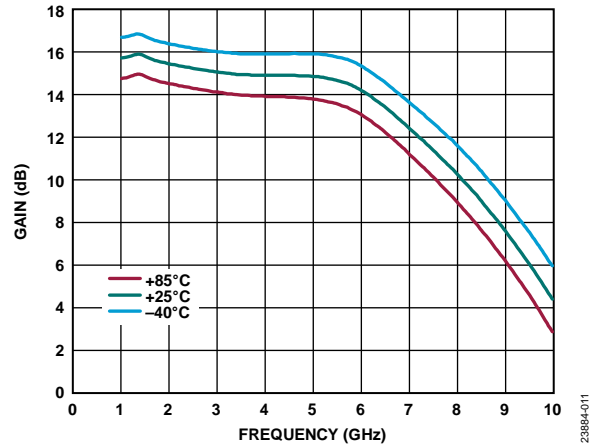

Figure 11. Gain vs. Frequency for Various Temperatures, 1 GHz to 10 GHz, $V_{DD} = 5 V$, $I_{DQ} = 150 mA$, $R_{BIAS} = 90.9 \Omega$

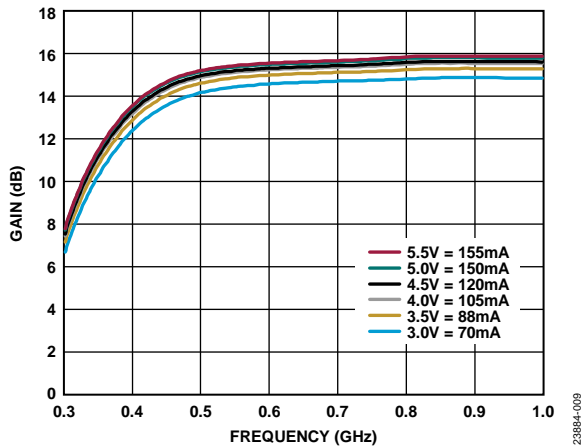

Figure 9. Gain vs. Frequency for Various V_{DD} and I_{DQ} Values, 0.3 GHz to 1 GHz, $R_{BIAS} = 90.9 \Omega$

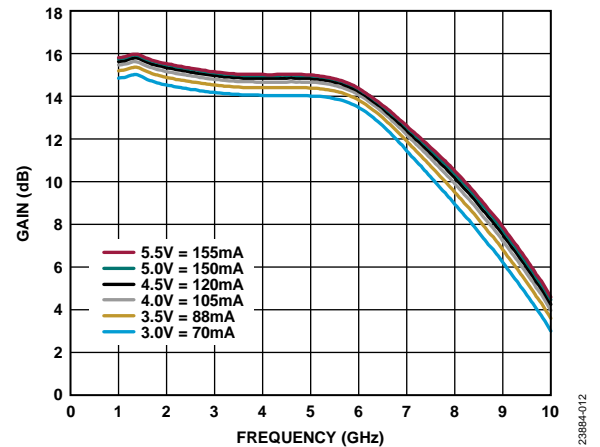

Figure 12. Gain vs. Frequency for Various V_{DD} and I_{DQ} Values, 1 GHz to 10 GHz, $R_{BIAS} = 90.9 \Omega$

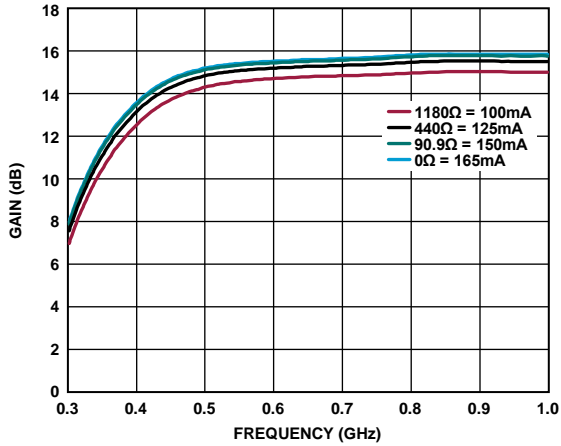

Figure 13. Gain vs. Frequency for Various R_{BIAS} and I_{DQ} Values, 0.3 GHz to 1 GHz, $V_{DD} = 5 V$

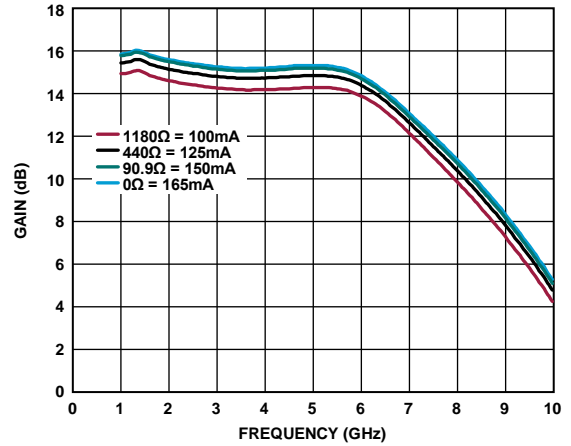

Figure 16. Gain vs. Frequency for Various R_{BIAS} and I_{DQ} Values, 1 GHz to 10 GHz, $V_{DD} = 5 V$

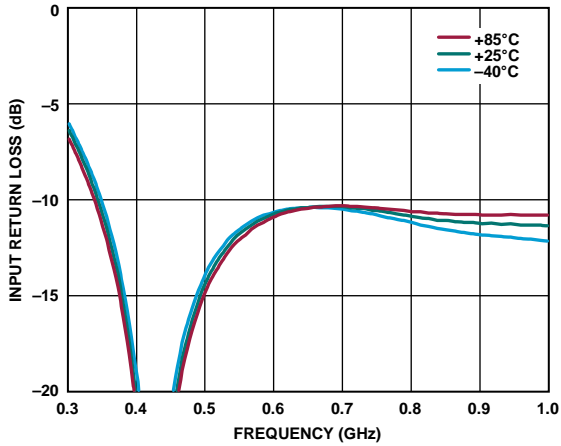

Figure 14. Input Return Loss vs. Frequency for Various Temperatures, 0.3 GHz to 1 GHz, $V_{DD} = 5 V$, $I_{DQ} = 150 mA$, $R_{BIAS} = 90.9 \Omega$

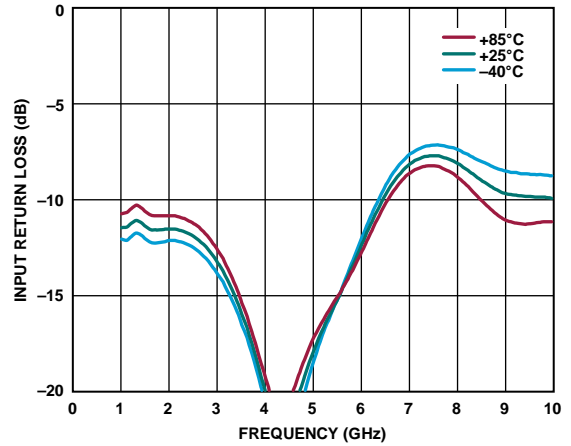

Figure 17. Input Return Loss vs. Frequency for Various Temperatures, 1 GHz to 10 GHz, $V_{DD} = 5 V$, $I_{DQ} = 150 mA$, $R_{BIAS} = 90.9 \Omega$

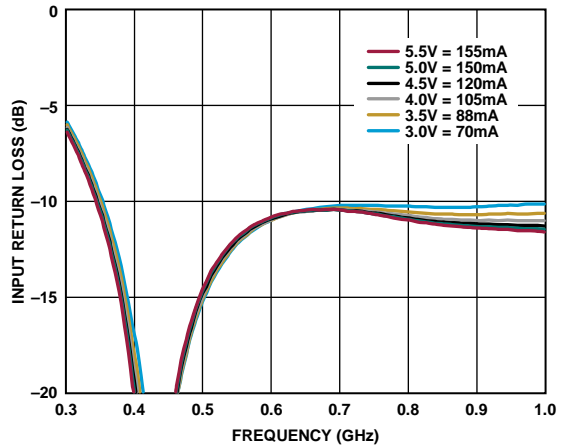

Figure 15. Input Return Loss vs. Frequency for Various V_{DD} and I_{DQ} Values, 0.3 GHz to 1 GHz, $R_{BIAS} = 90.9 \Omega$

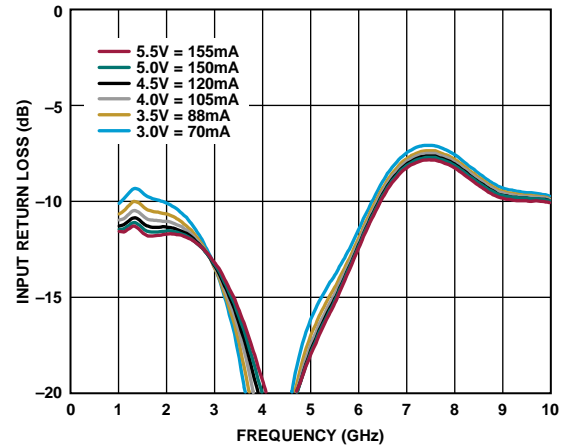

Figure 18. Input Return Loss vs. Frequency for Various V_{DD} and I_{DQ} Values, 1 GHz to 10 GHz, $R_{BIAS} = 90.9 \Omega$

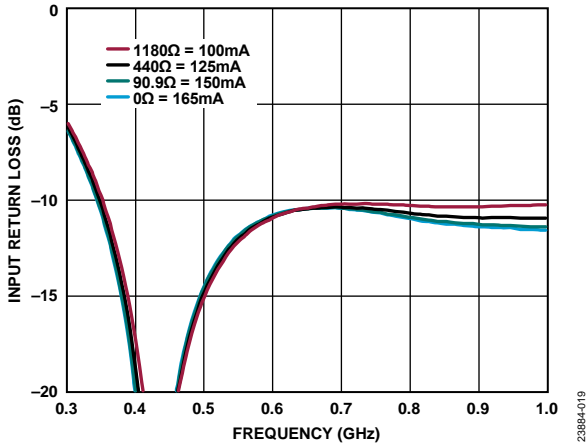

Figure 19. Input Return Loss vs. Frequency for Various R_{BIAS} and I_{DQ} Values, 0.3 GHz to 1 GHz, $V_{DD} = 5 V$

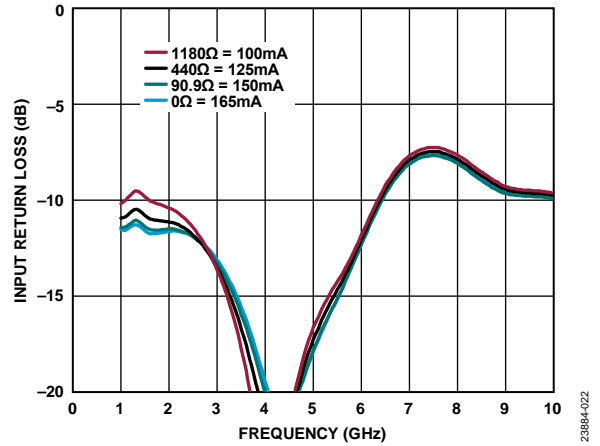

Figure 22. Input Return Loss vs. Frequency for Various R_{BIAS} and I_{DQ} Values, 1 GHz to 10 GHz, $V_{DD} = 5 V$

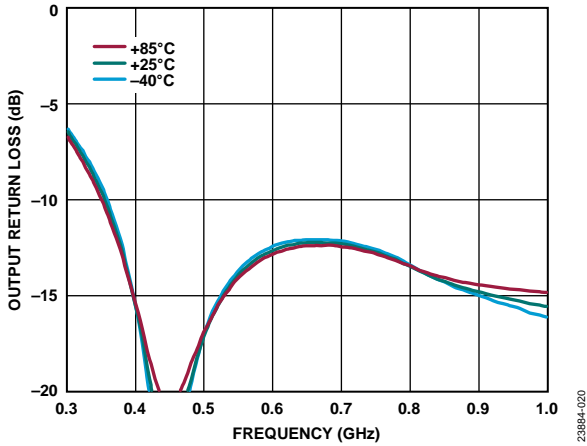

Figure 20. Output Return Loss vs. Frequency for Various Temperatures, 0.3 GHz to 1 GHz, $V_{DD} = 5 V$, $I_{DQ} = 150 mA$, $R_{BIAS} = 90.9 \Omega$

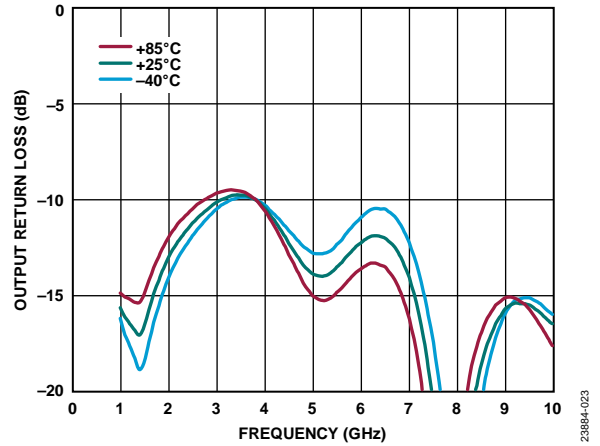

Figure 23. Output Return Loss vs. Frequency for Various Temperatures, 1 GHz to 10 GHz, $V_{DD} = 5 V$, $I_{DQ} = 150 mA$, $R_{BIAS} = 90.9 \Omega$

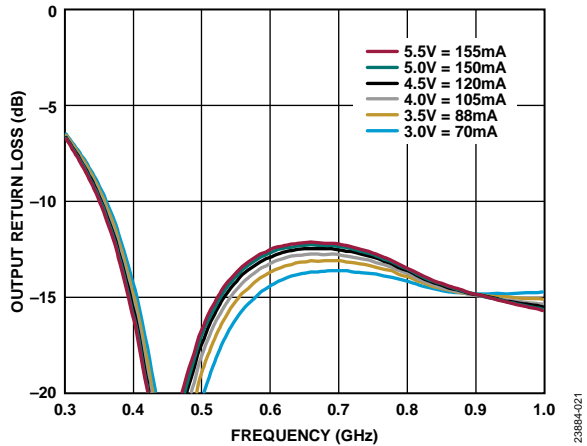

Figure 21. Output Return Loss vs. Frequency for Various V_{DD} and I_{DQ} Values, 0.3 GHz to 1 GHz, $R_{BIAS} = 90.9 \Omega$

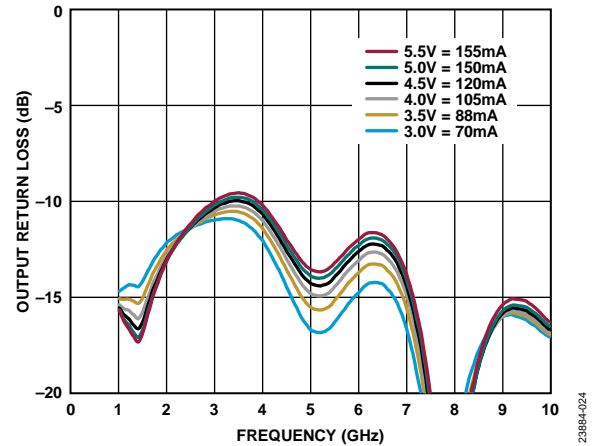

Figure 24. Output Return Loss vs. Frequency for Various V_{DD} and I_{DQ} Values, 1 GHz to 10 GHz, $R_{BIAS} = 90.9 \Omega$

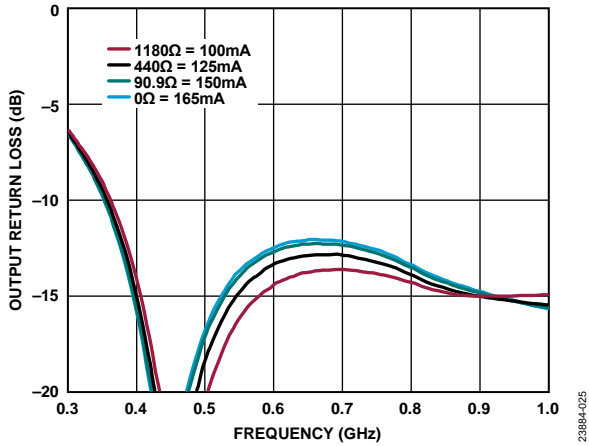

Figure 25. Output Return Loss vs. Frequency for Various R_{BIAS} and I_{DQ} Values, 0.3 GHz to 1 GHz, $V_{DD} = 5 V$

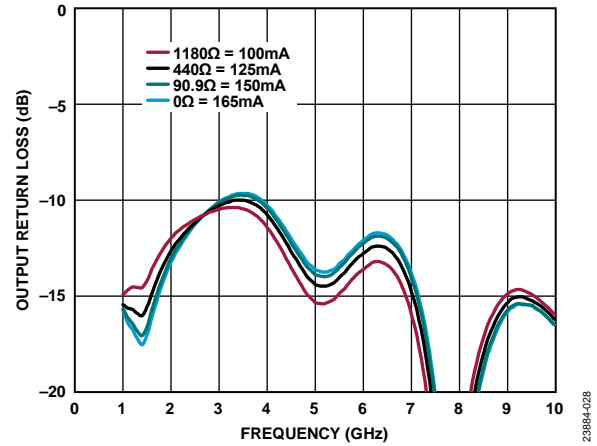

Figure 28. Output Return Loss vs. Frequency for Various R_{BIAS} and I_{DQ} Values, 1 GHz to 10 GHz, $V_{DD} = 5 V$

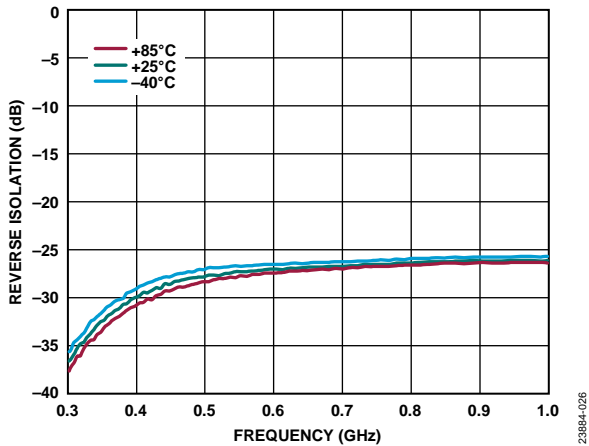

Figure 26. Reverse Isolation vs. Frequency for Various Temperatures, 0.3 GHz to 1 GHz, $V_{DD} = 5 V$, $I_{DQ} = 150 mA$, $R_{BIAS} = 90.9 \Omega$

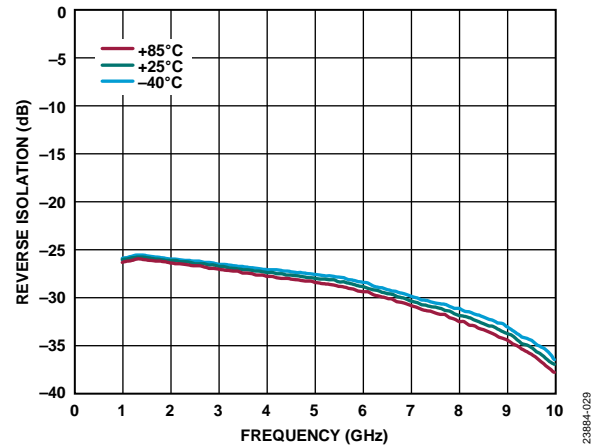

Figure 29. Reverse Isolation vs. Frequency for Various Temperatures, 1 GHz to 10 GHz, $V_{DD} = 5 V$, $I_{DQ} = 150 mA$, $R_{BIAS} = 90.9 \Omega$

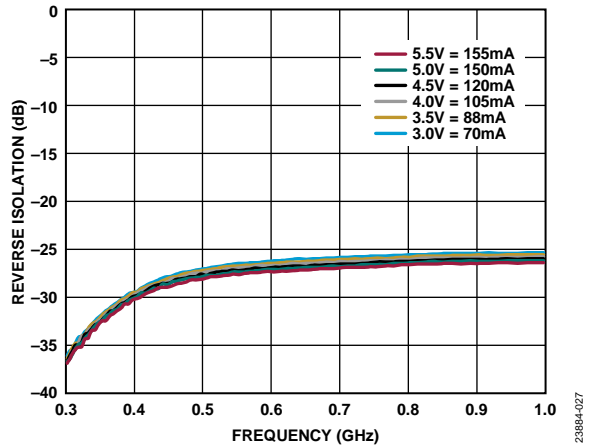

Figure 27. Reverse Isolation vs. Frequency for Various V_{DD} and I_{DQ} Values, 0.3 GHz to 1 GHz, $R_{BIAS} = 90.9 \Omega$

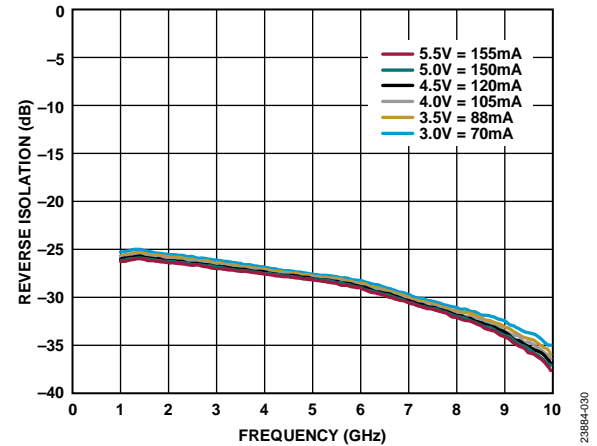

Figure 30. Reverse Isolation vs. Frequency for Various V_{DD} and I_{DQ} Values, 1 GHz to 10 GHz, $R_{BIAS} = 90.9 \Omega$

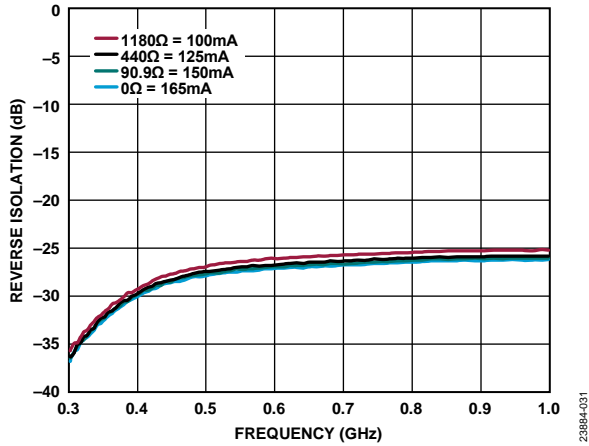

Figure 31. Reverse Isolation vs. Frequency for Various R_{BIAS} and I_{DQ} Values, 0.3 GHz to 1 GHz, $V_{DD} = 5 V$

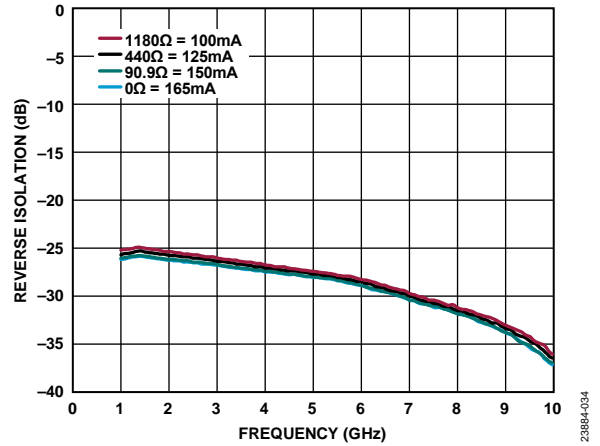

Figure 34. Reverse Isolation vs. Frequency for Various R_{BIAS} and I_{DQ} Values, 1 GHz to 10 GHz, $V_{DD} = 5 V$

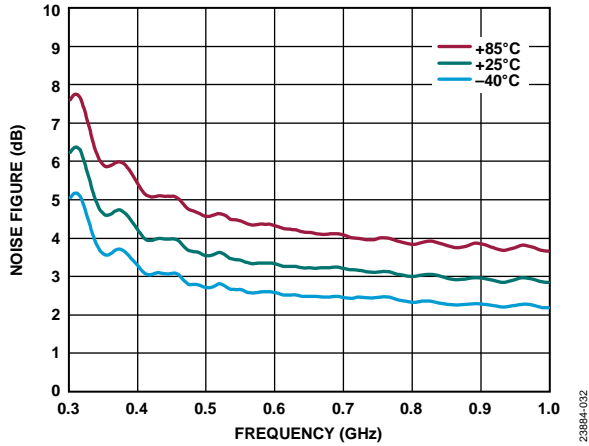

Figure 32. Noise Figure vs. Frequency for Various Temperatures, 0.3 GHz to 1 GHz, $V_{DD} = 5 V$, $I_{DQ} = 150 mA$, $R_{BIAS} = 90.9 \Omega$

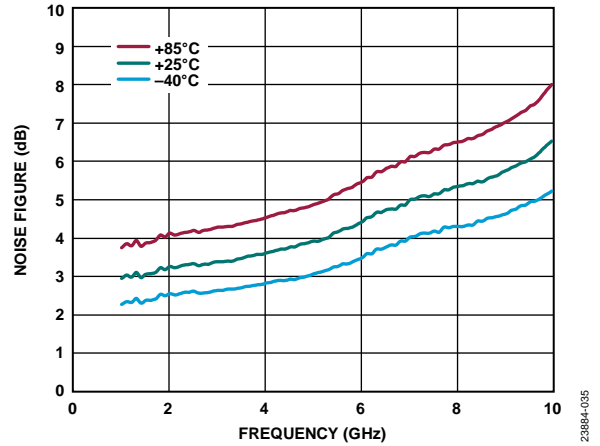

Figure 35. Noise Figure vs. Frequency for Various Temperatures, 1 GHz to 10 GHz, $V_{DD} = 5 V$, $I_{DQ} = 150 mA$, $R_{BIAS} = 90.9 \Omega$

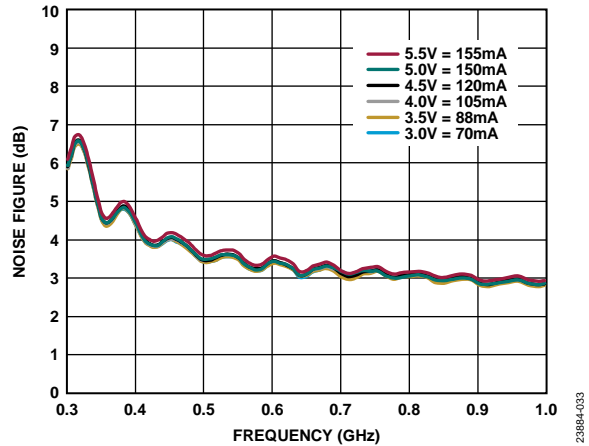

Figure 33. Noise Figure vs. Frequency for Various V_{DD} and I_{DQ} Values, 0.3 GHz to 1 GHz, $R_{BIAS} = 90.9 \Omega$

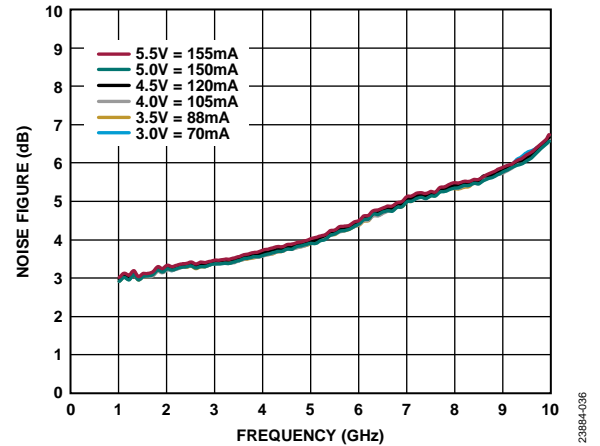

Figure 36. Noise Figure vs. Frequency for Various V_{DD} and I_{DQ} Values, 1 GHz to 10 GHz, $R_{BIAS} = 90.9 \Omega$

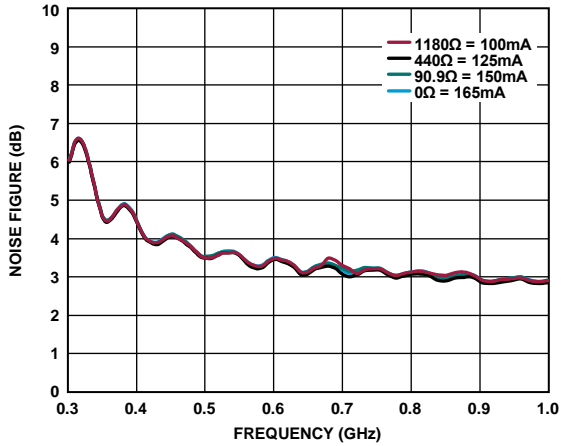

Figure 37. Noise Figure vs. Frequency for Various R_{BIAS} and I_{DQ} Values, 0.3 GHz to 1 GHz, $V_{DD} = 5V$

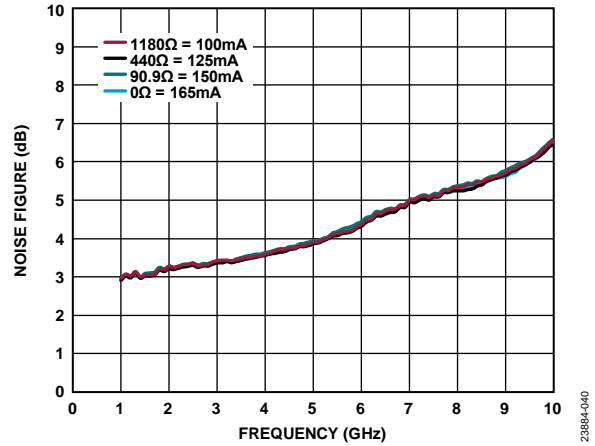

Figure 40. Noise Figure vs. Frequency for Various R_{BIAS} and I_{DQ} Values, 1 GHz to 10 GHz, $V_{DD} = 5V$

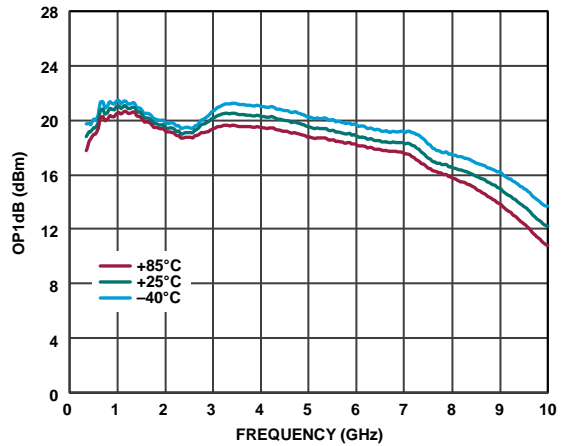

Figure 38. $OP1dB$ vs. Frequency for Various Temperatures, 0.35 GHz to 10 GHz, $V_{DD} = 5V$, $I_{DQ} = 150mA$, $R_{BIAS} = 90.9\Omega$

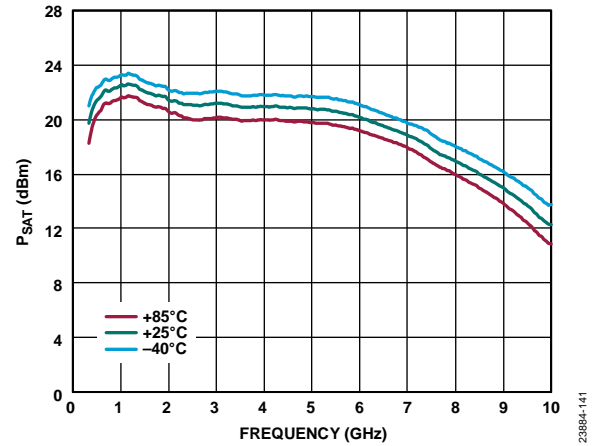

Figure 41. P_{SAT} vs. Frequency for Various Temperatures, 0.35 GHz to 10 GHz, $V_{DD} = 5V$, $I_{DQ} = 150mA$, $R_{BIAS} = 90.9\Omega$

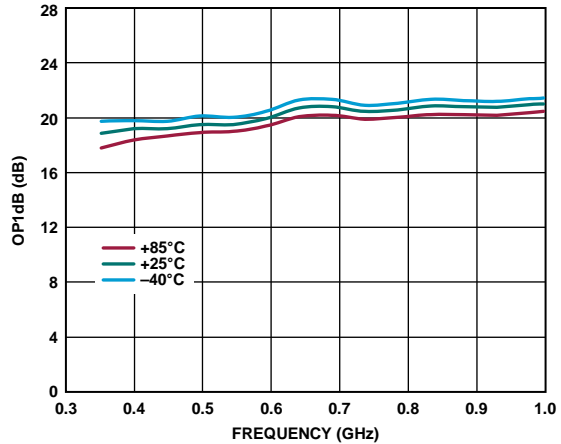

Figure 39. $OP1dB$ vs. Frequency for Various Temperatures, 0.35 GHz to 1 GHz, $V_{DD} = 5V$, $I_{DQ} = 150mA$, $R_{BIAS} = 90.9\Omega$

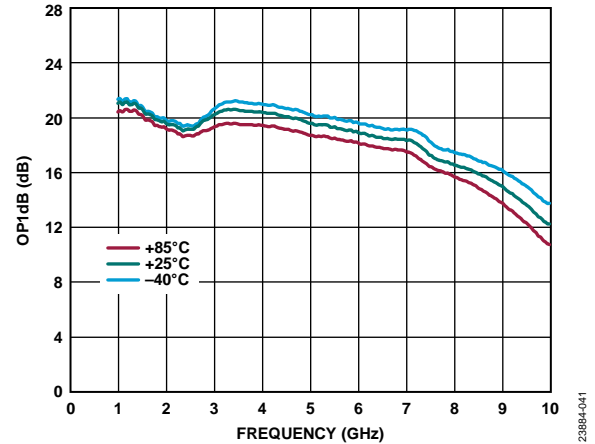

Figure 42. $OP1dB$ vs. Frequency for Various Temperatures, 1 GHz to 10 GHz, $V_{DD} = 5V$, $I_{DQ} = 150mA$, $R_{BIAS} = 90.9\Omega$

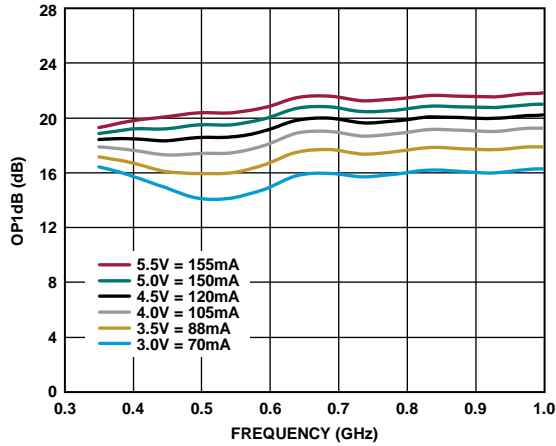

Figure 43. OP1dB vs. Frequency for Various V_{DD} and I_{DQ} Values, 0.35 GHz to 1 GHz, $R_{BIAS} = 90.9 \Omega$

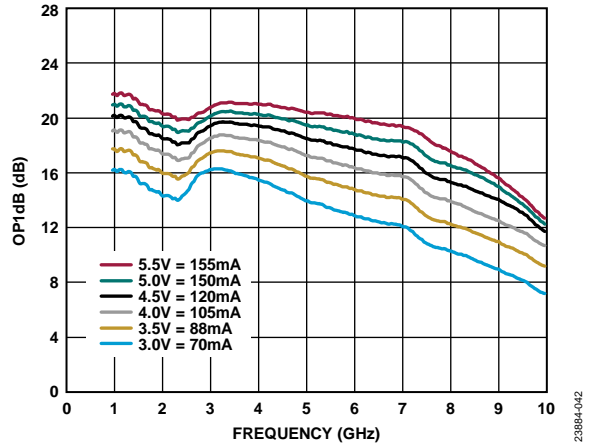

Figure 46. OP1dB vs. Frequency for Various V_{DD} and I_{DQ} Values, 1 GHz to 10 GHz, $R_{BIAS} = 90.9 \Omega$

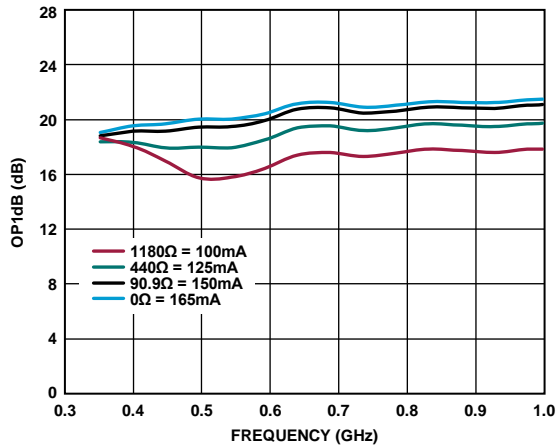

Figure 44. OP1dB vs. Frequency for Various R_{BIAS} and I_{DQ} Values, 0.35 GHz to 1 GHz, $V_{DD} = 5 V$

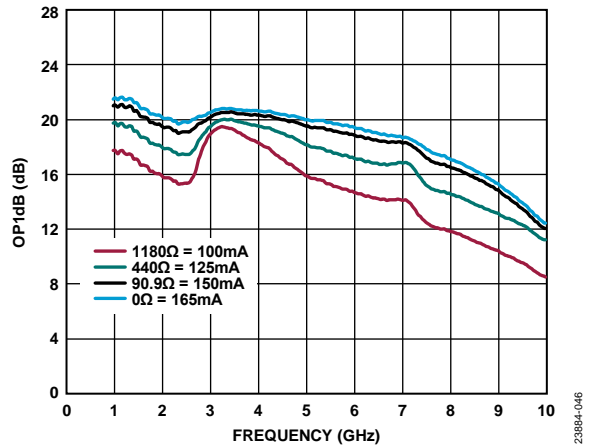

Figure 47. OP1dB vs. Frequency for Various R_{BIAS} and I_{DQ} Values, 1 GHz to 10 GHz, $V_{DD} = 5 V$

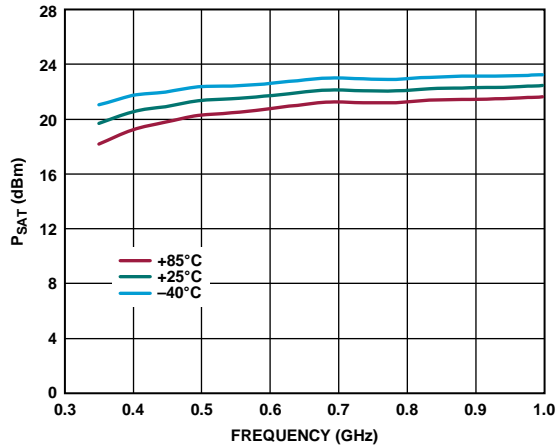

Figure 45. P_{SAT} vs. Frequency for Various Temperatures, 0.35 GHz to 1 GHz, $V_{DD} = 5 V$, $I_{DQ} = 150 mA$, $R_{BIAS} = 90.9 \Omega$

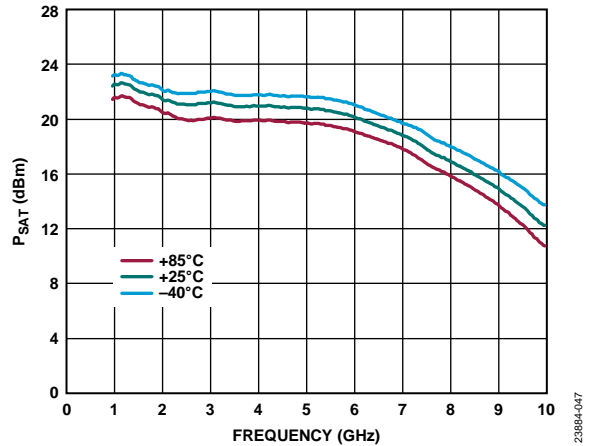

Figure 48. P_{SAT} vs. Frequency for Various Temperatures, 1 GHz to 10 GHz, $V_{DD} = 5 V$, $I_{DQ} = 150 mA$, $R_{BIAS} = 90.9 \Omega$

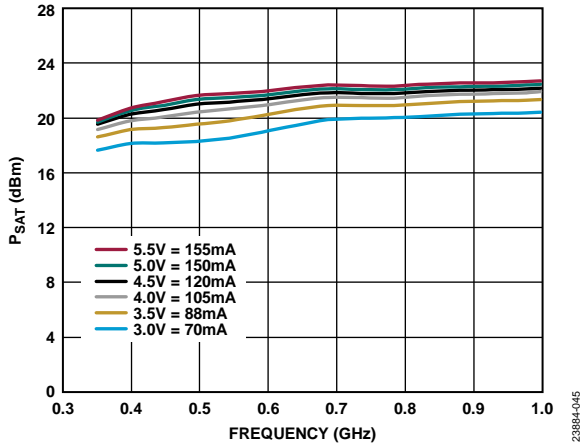

Figure 49. P_{SAT} vs. Frequency for Various V_{DD} and I_{DQ} Values, 0.35 GHz to 1 GHz, $R_{BIAS} = 90.9 \Omega$

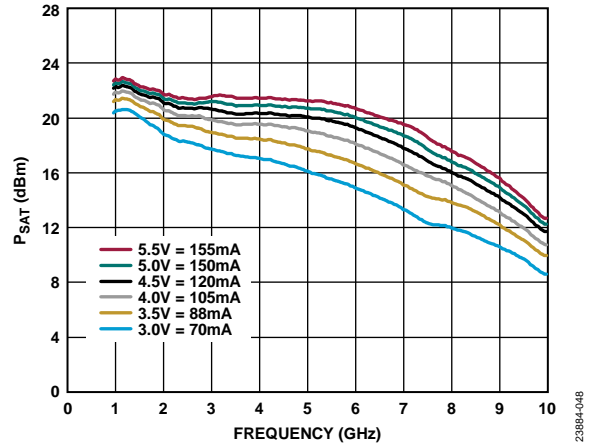

Figure 52. P_{SAT} vs. Frequency for Various V_{DD} and I_{DQ} Values, 1 GHz to 10 GHz, $R_{BIAS} = 90.9 \Omega$

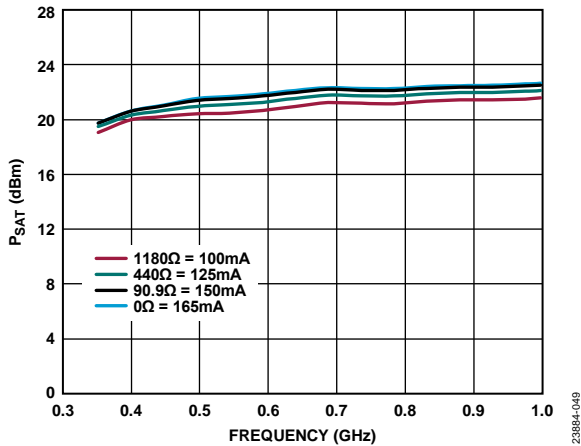

Figure 50. P_{SAT} vs. Frequency for Various R_{BIAS} and I_{DQ} Values, 0.35 GHz to 1 GHz, $V_{DD} = 5 V$

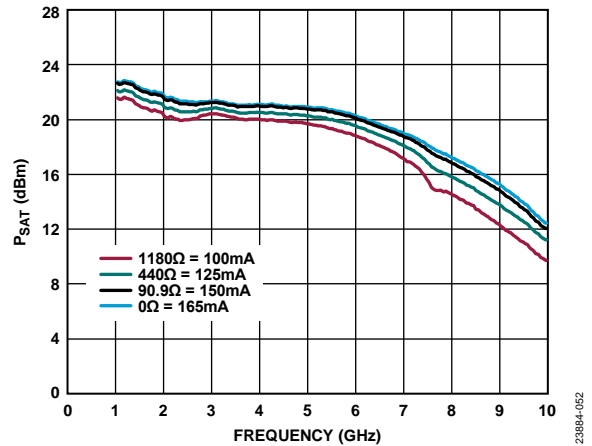

Figure 53. P_{SAT} vs. Frequency for Various R_{BIAS} and I_{DQ} Values, 1 GHz to 10 GHz, $V_{DD} = 5 V$

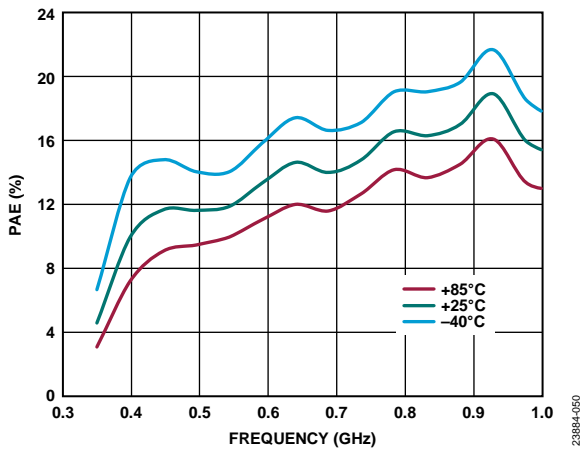

Figure 51. PAE vs. Frequency for Various Temperatures, 0.35 GHz to 1 GHz, $V_{DD} = 5 V$, $I_{DQ} = 150 mA$, $R_{BIAS} = 90.9 \Omega$

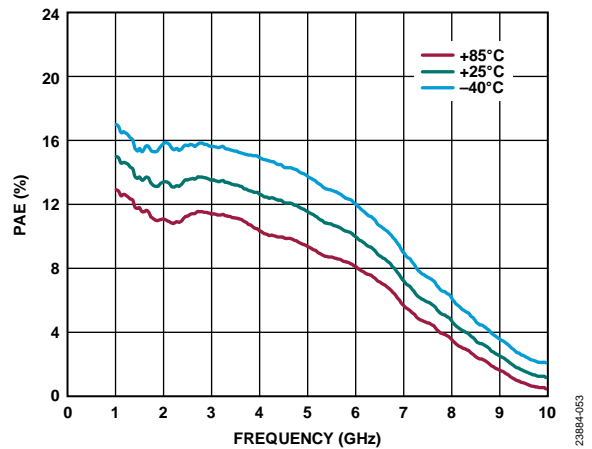

Figure 54. PAE vs. Frequency for Various Temperatures, 1 GHz to 10 GHz, $V_{DD} = 5 V$, $I_{DQ} = 150 mA$, $R_{BIAS} = 90.9 \Omega$

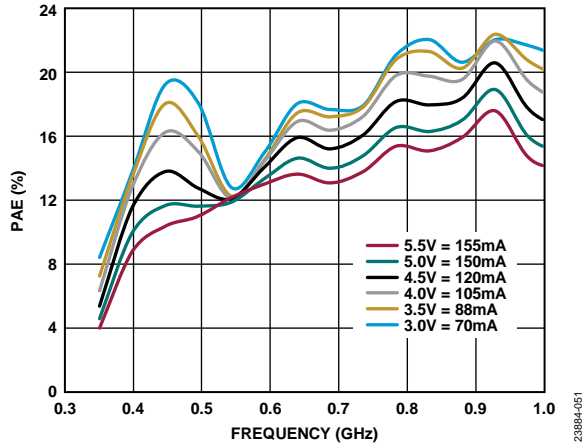

Figure 55. PAE vs. Frequency for Various V_{DD} and I_{DQ} Values, 0.35 GHz to 1 GHz, $R_{BIAS} = 90.9 \Omega$

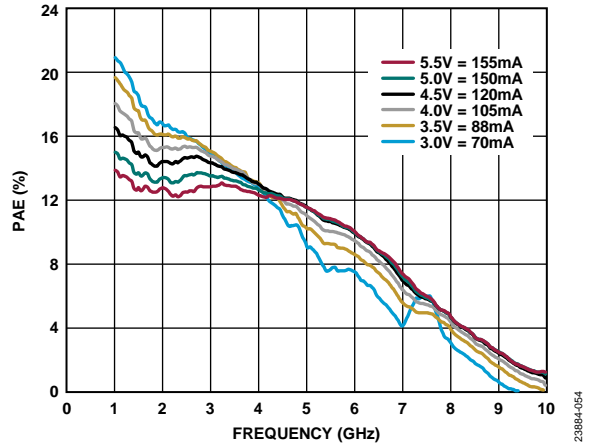

Figure 58. PAE vs. Frequency for Various V_{DD} and I_{DQ} Values, 1 GHz to 10 GHz, $R_{BIAS} = 90.9 \Omega$

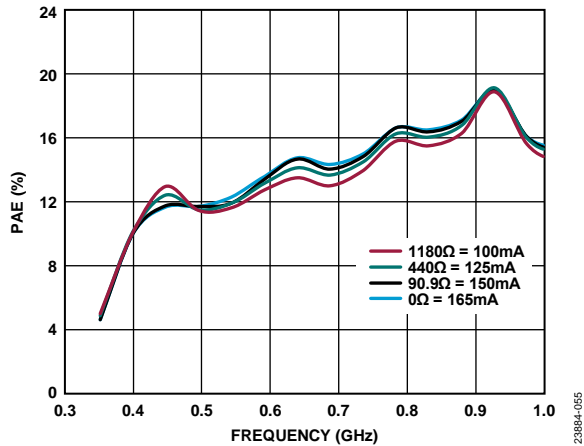

Figure 56. PAE vs. Frequency for Various R_{BIAS} and I_{DQ} Values, 0.3 GHz to 1 GHz, $V_{DD} = 5 V$

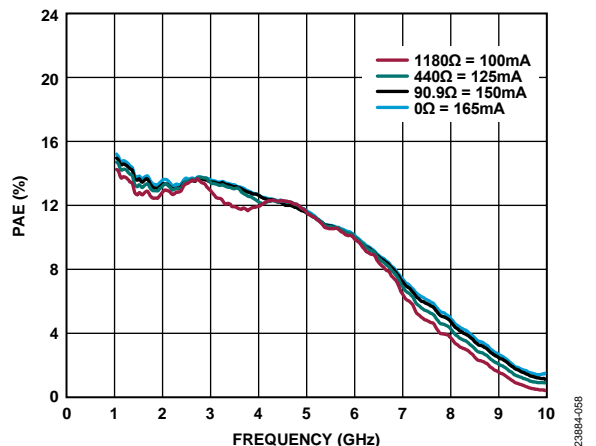

Figure 59. PAE vs. Frequency for Various R_{BIAS} and I_{DQ} Values, 1 GHz to 10 GHz, $V_{DD} = 5 V$

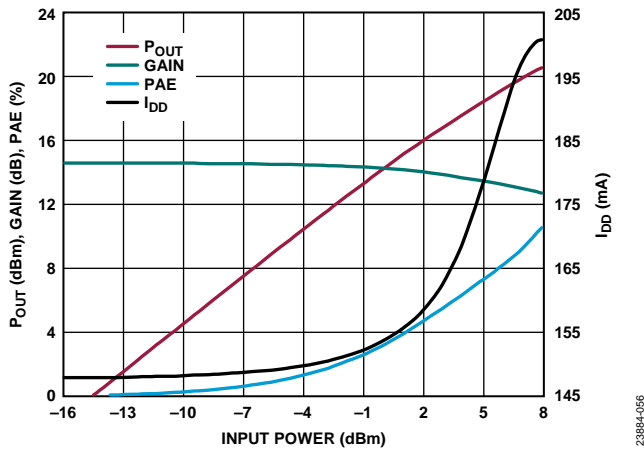

Figure 57. P_{OUT} , Gain, PAE, and I_{DD} vs. Input Power, Power Compression at 0.4 GHz, $V_{DD} = 5 V$, $R_{BIAS} = 90.9 \Omega$

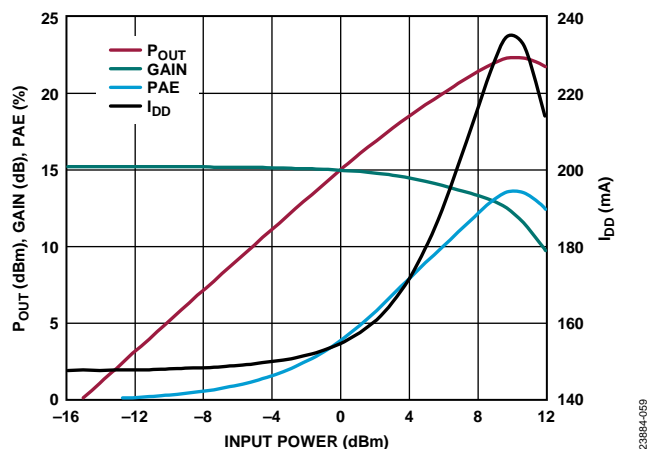

Figure 60. P_{OUT} , Gain, PAE, and I_{DD} vs. Input Power, Power Compression at 2 GHz, $V_{DD} = 5 V$, $R_{BIAS} = 90.9 \Omega$

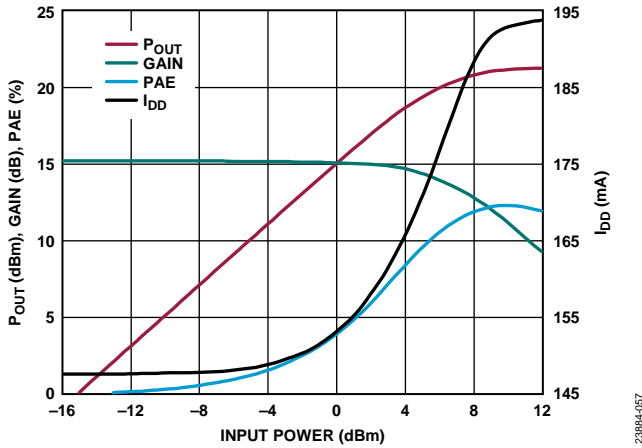

Figure 61. P_{OUT} , Gain, PAE, and I_{DD} vs. Input Power, Power Compression at 5 GHz, $V_{DD} = 5\text{ V}$, $R_{BIAS} = 90.9\ \Omega$

23884-057

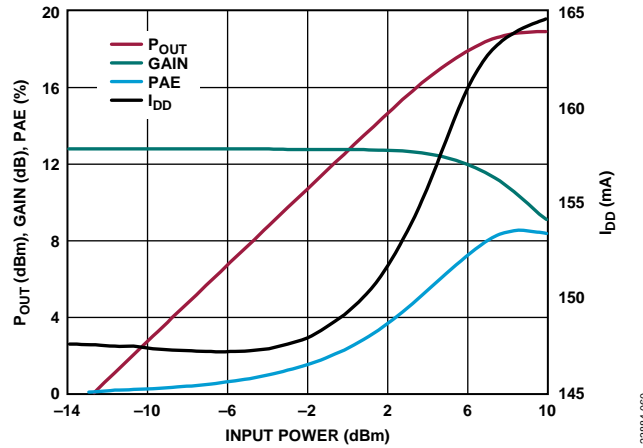

Figure 64. P_{OUT} , Gain, PAE, and I_{DD} vs. Input Power, Power Compression at 7 GHz, $V_{DD} = 5\text{ V}$, $R_{BIAS} = 90.9\ \Omega$

23884-060

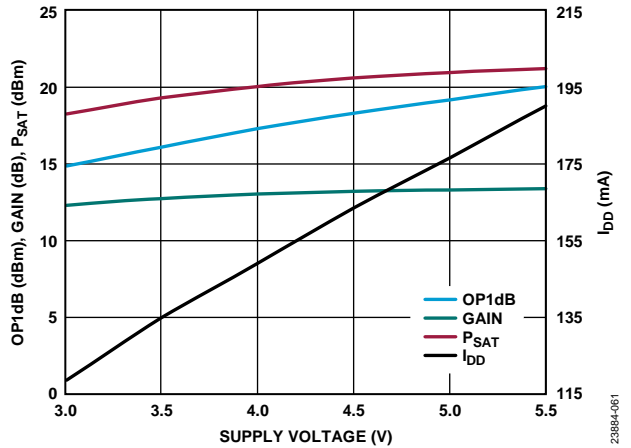

Figure 62. OP1dB, Gain, P_{SAT} , and I_{DD} (Measured at P_{SAT}) vs. Supply Voltage, Power Compression at 0.4 GHz, $R_{BIAS} = 90.9\ \Omega$

23884-061

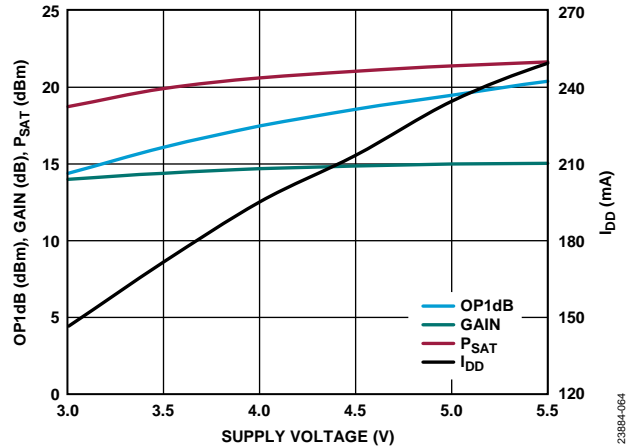

Figure 65. OP1dB, Gain, P_{SAT} , and I_{DD} (Measured at P_{SAT}) vs. Supply Voltage, Power Compression at 2 GHz, $R_{BIAS} = 90.9\ \Omega$

23884-064

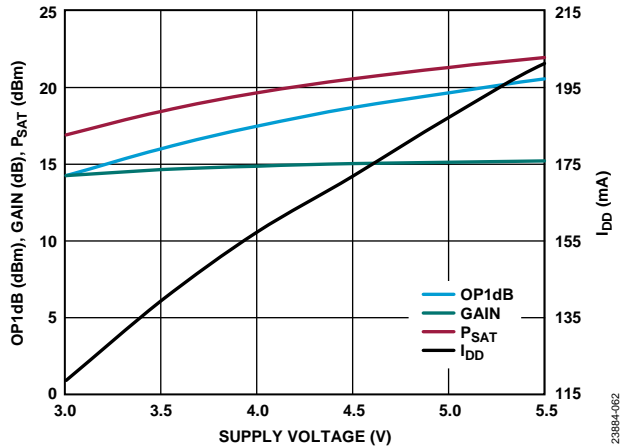

Figure 63. OP1dB, Gain, P_{SAT} , and I_{DD} (Measured at P_{SAT}) vs. Supply Voltage, Power Compression at 5 GHz, $R_{BIAS} = 90.9\ \Omega$

23884-062

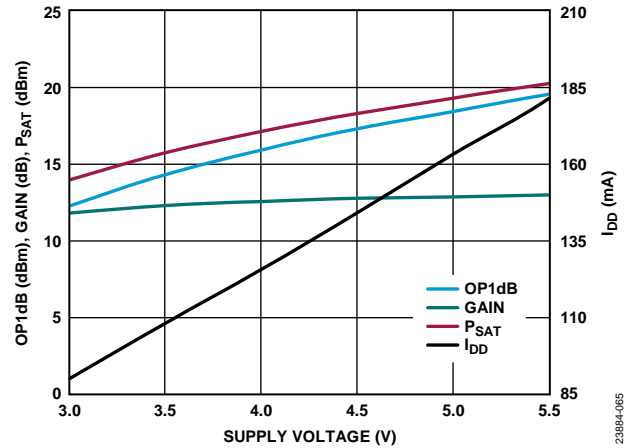

Figure 66. OP1dB, Gain, P_{SAT} , and I_{DD} (Measured at P_{SAT}) vs. Supply Voltage, Power Compression at 7 GHz, $R_{BIAS} = 90.9\ \Omega$

23884-065

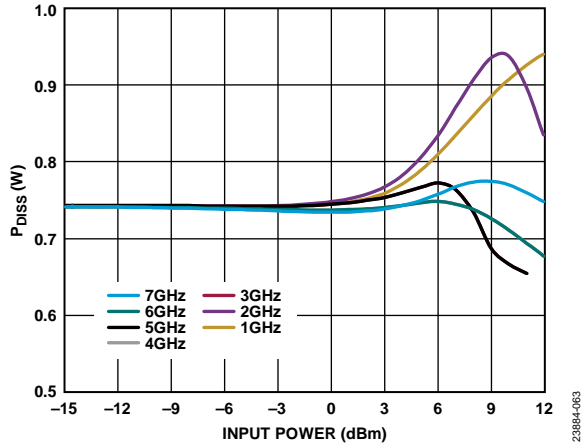

Figure 67. P_{DISS} vs. Input Power at $T_A = 85^\circ\text{C}$, $V_{DD} = 5\text{ V}$, $I_{DQ} = 150\text{ mA}$, $R_{BIAS} = 90.9\ \Omega$

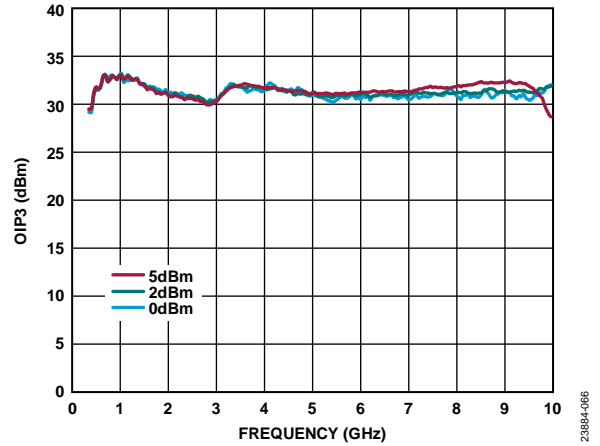

Figure 70. $OIP3$ vs. Frequency for Various P_{OUT} per Tone, $V_{DD} = 5\text{ V}$, $R_{BIAS} = 90.9\ \Omega$, $I_{DQ} = 150\text{ mA}$

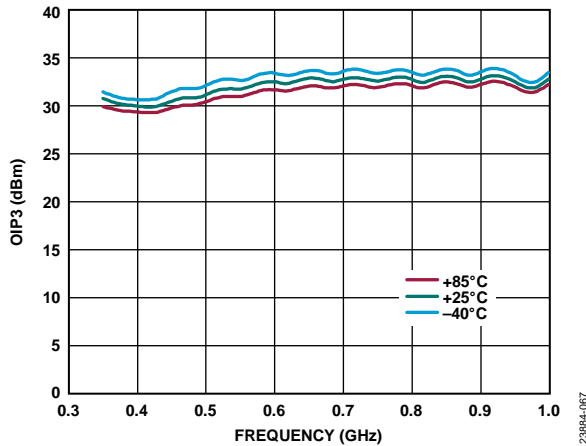

Figure 68. $OIP3$ vs. Frequency for Various Temperatures, 0.35 GHz to 1 GHz, $V_{DD} = 5\text{ V}$, $I_{DQ} = 150\text{ mA}$, $R_{BIAS} = 90.9\ \Omega$, P_{OUT} per Tone = 5 dBm

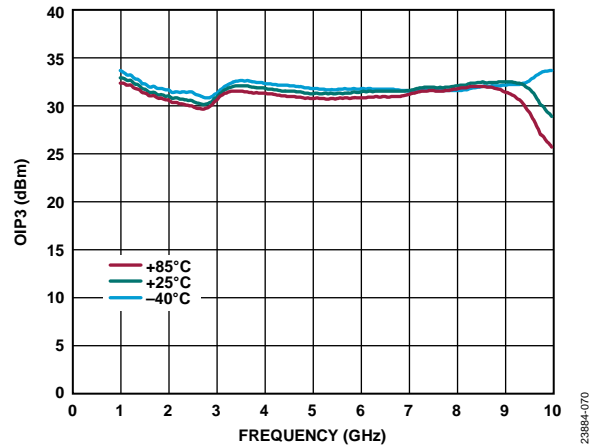

Figure 71. $OIP3$ vs. Frequency for Various Temperatures, 1 GHz to 10 GHz, $V_{DD} = 5\text{ V}$, $I_{DQ} = 150\text{ mA}$, $R_{BIAS} = 90.9\ \Omega$, P_{OUT} per Tone = 5 dBm

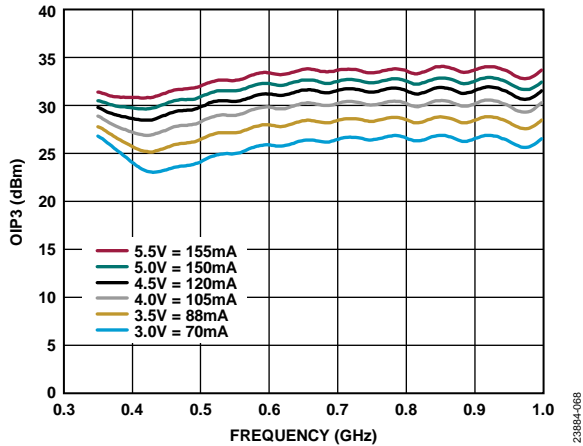

Figure 69. $OIP3$ vs. Frequency for Various V_{DD} and I_{DQ} Values, 0.3 GHz to 1 GHz, $V_{DD} = 5\text{ V}$, P_{OUT} per Tone = 5 dBm

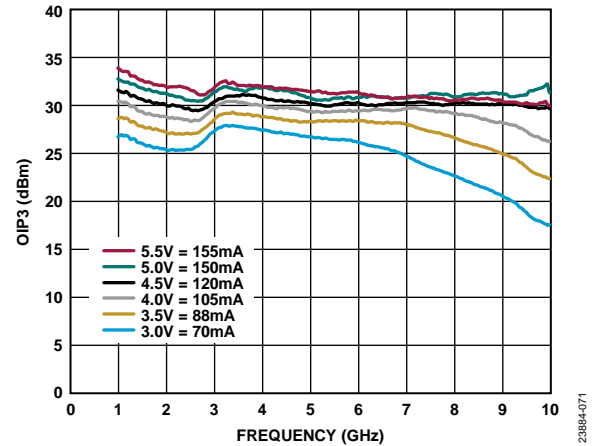

Figure 72. $OIP3$ vs. Frequency for Various V_{DD} and I_{DQ} Values, 1 GHz to 10 GHz, $V_{DD} = 5\text{ V}$, P_{OUT} per Tone = 5 dBm

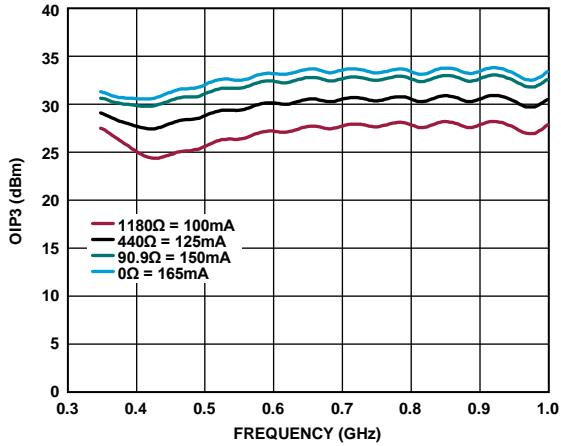

Figure 73. OIP3 vs. Frequency for Various R_{BIAS} and I_{DQ} Values, 0.3 GHz to 1 GHz, $V_{DD} = 5V$, P_{OUT} per Tone = 5 dBm

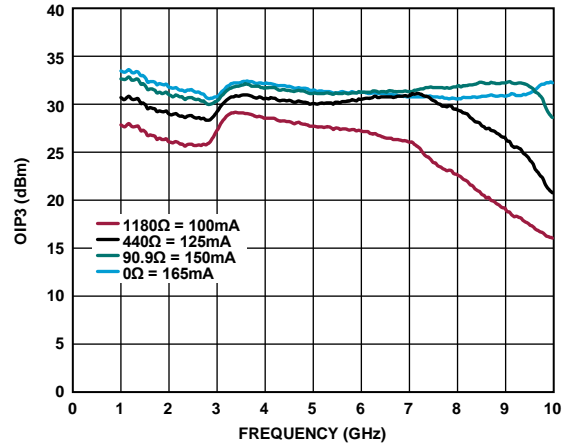

Figure 76. OIP3 vs. Frequency for Various R_{BIAS} and I_{DQ} Values, 1 GHz to 10 GHz, $V_{DD} = 5V$, P_{OUT} per Tone = 5 dBm

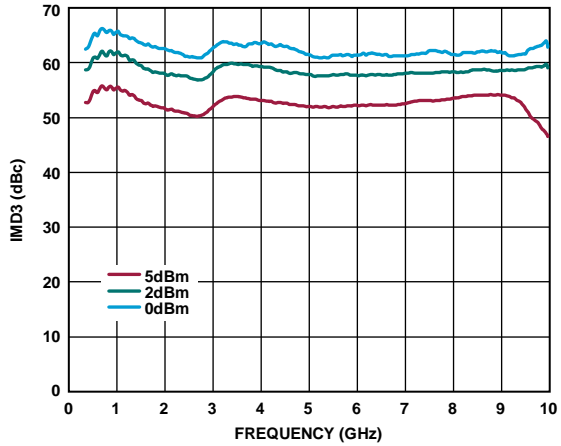

Figure 74. Third-Order Intermodulation Distortion Relative to Carrier (IMD3) vs. Frequency for Various P_{OUT} per Tone, $V_{DD} = 5V$, $I_{DQ} = 150mA$, $R_{BIAS} = 90.9\Omega$

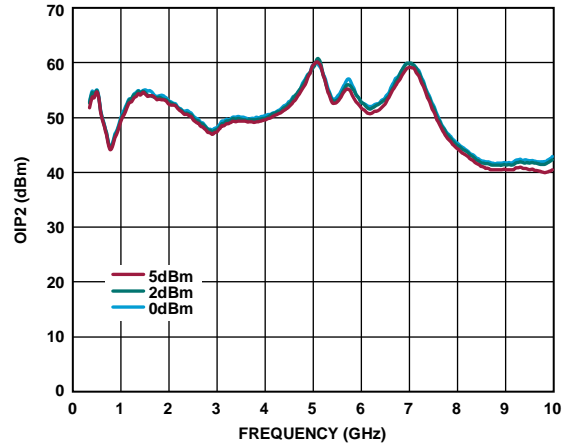

Figure 77. OIP2 vs. Frequency for Various P_{OUT} per Tone, $V_{DD} = 5V$, $I_{DQ} = 150mA$, $R_{BIAS} = 90.9\Omega$

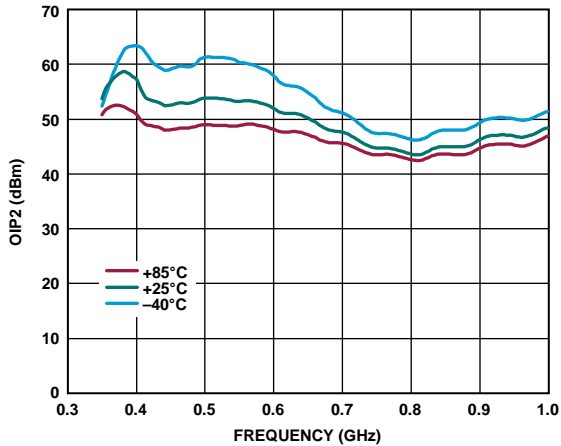

Figure 75. OIP2 vs. Frequency for Various Temperatures, 0.35 GHz to 1 GHz, $V_{DD} = 5V$, $I_{DQ} = 150mA$, $R_{BIAS} = 90.9\Omega$, P_{OUT} per Tone = 5 dBm

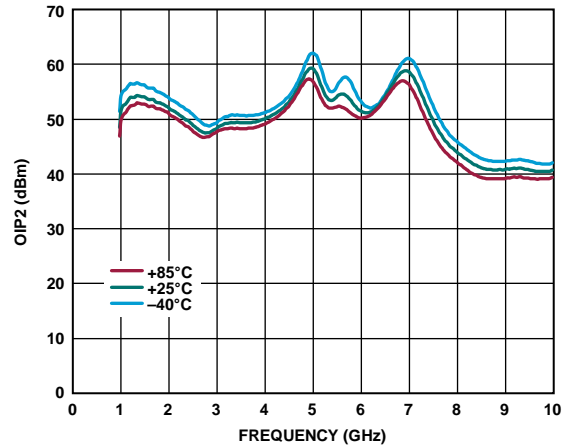

Figure 78. OIP2 vs. Frequency for Various Temperatures, 1 GHz to 10 GHz, $V_{DD} = 5V$, $I_{DQ} = 150mA$, $R_{BIAS} = 90.9\Omega$, P_{OUT} per Tone = 5 dBm

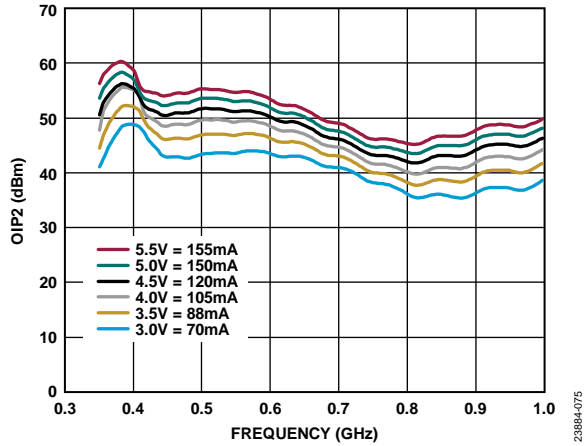

Figure 79. OIP2 vs. Frequency for Various V_{DD} and I_{DQ} Values, 0.35 GHz to 1 GHz, $R_{BIAS} = 90.9 \Omega$, P_{OUT} per Tone = 5 dBm

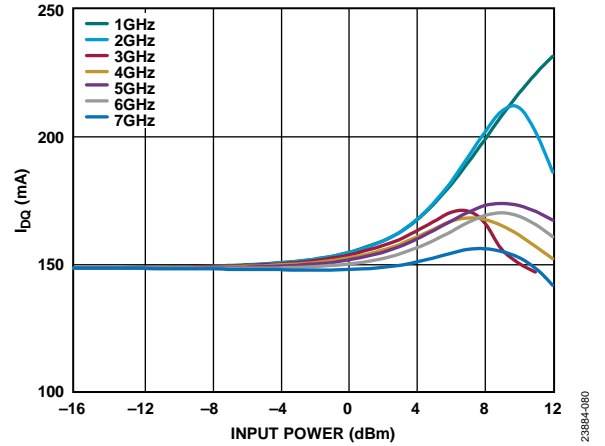

Figure 81. I_{DQ} vs. Input Power for Various Frequencies, $V_{DD} = 5 V$, $R_{BIAS} = 90.9 \Omega$

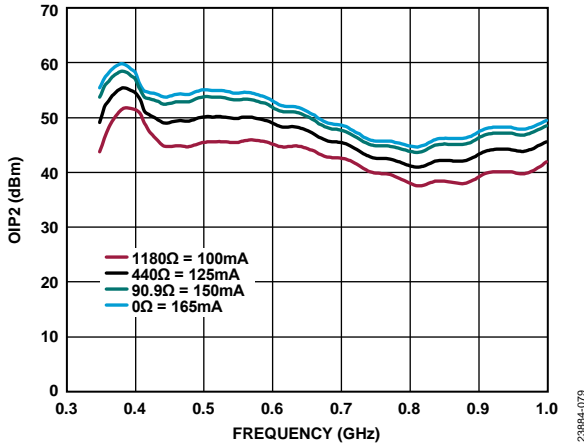

Figure 80. OIP2 vs. Frequency for Various R_{BIAS} and I_{DQ} Values, 0.3 GHz to 1 GHz, $V_{DD} = 5 V$, P_{OUT} per Tone = 5 dBm

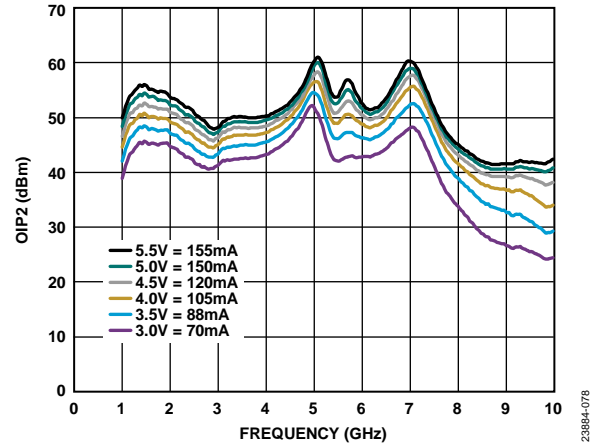

Figure 82. OIP2 vs. Frequency for Various V_{DD} and I_{DQ} Values, 1 GHz to 10 GHz, $R_{BIAS} = 90.9 \Omega$, P_{OUT} per Tone = 5 dBm

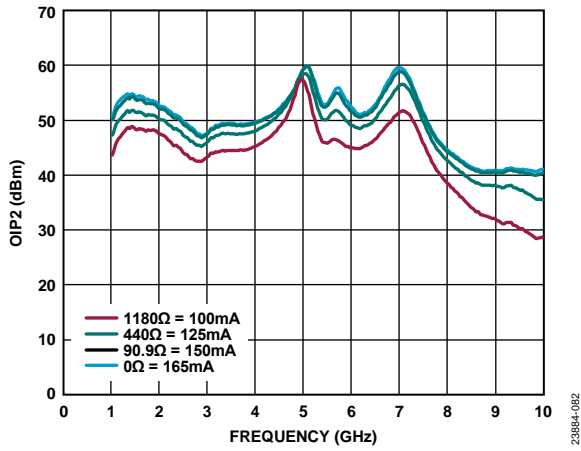

Figure 83. OIP2 vs. Frequency for Various R_{BIAS} and I_{DQ} Values, 1 GHz to 10 GHz, $V_{DD} = 5 V$, P_{OUT} per Tone = 5 dBm

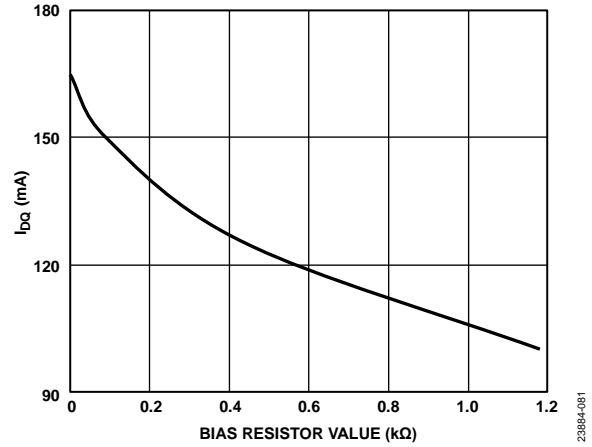

Figure 85. I_{DQ} vs. Bias Resistor Value, $V_{DD} = 5 V$

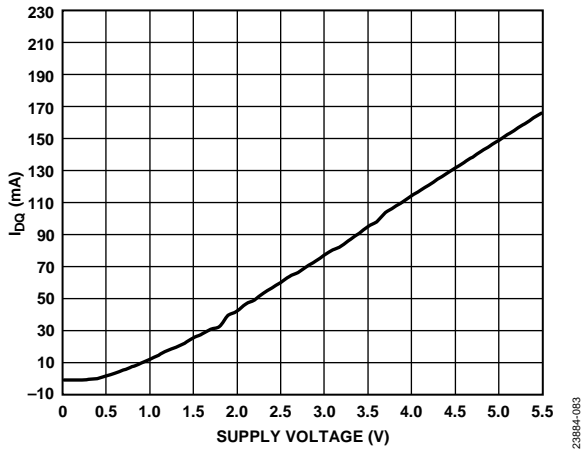

Figure 84. I_{DQ} vs. Supply Voltage, $R_{BIAS} = 90.9 \Omega$

23884-082

23884-081

23884-083

THEORY OF OPERATION

The ADL8104 is a GaAs, MMIC, pHEMT, low noise wideband amplifier with integrated ac-coupling capacitors and a bias inductor. Figure 86 shows a simplified schematic.

The ADL8104 has ac-coupled, single-ended input and output ports with impedances that are nominally equal to $50\ \Omega$ over the 0.4 GHz to 7.5 GHz frequency range. No external matching

components are required. To adjust the quiescent current, connect an external resistor between the R_{BIAS} and V_{DD} pins.

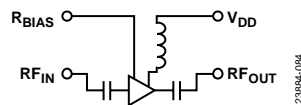

Figure 86. Simplified Schematic

APPLICATIONS INFORMATION

The basic connections for operating the ADL8104 over the specified frequency range are shown in Figure 87. No external biasing inductor is required, allowing the 5 V supply to be connected to the V_{DD} pin. The 1 μF and 1000 pF power supply decoupling capacitors are recommended. The power supply decoupling capacitors shown in Figure 87 represent the configuration used to characterize and qualify the ADL8104.

To set I_{DQ}, connect a resistor, R1, between the R_{BIAS} and V_{DD} pins. A default value of 90.9 Ω is recommended, which results in a nominal I_{DQ} of 150 mA. Table 9 shows how the I_{DQ} and I_{DD} varies vs. the bias resistor value. The R_{BIAS} pin also draws a current that varies with the value of R_{BIAS} (see Table 9). Do not leave the R_{BIAS} pin open.

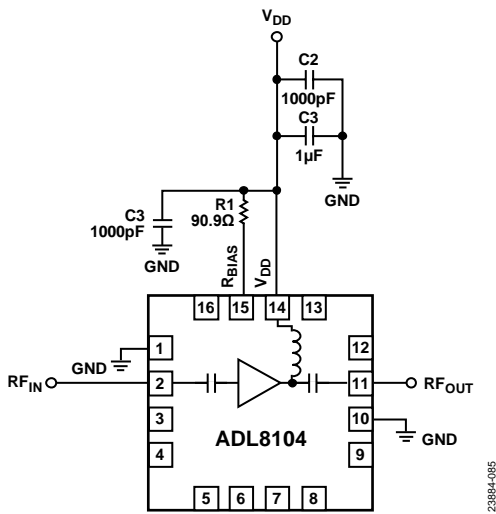

Figure 87. Typical Application Circuit

RECOMMENDED BIAS SEQUENCING

See the [ADL8104-EVALZ](#) user guide for the recommended bias sequencing information.

Table 9. Recommended Bias Resistor Values

R _{BIAS} (Ω)	I _{DQ} (mA)	I _{DD} (mA)	I _{RBIAS} (mA)
0	165	157.3	7.7
90	150	144	6
440	125	120	5
1180	100	97	3

OUTLINE DIMENSIONS

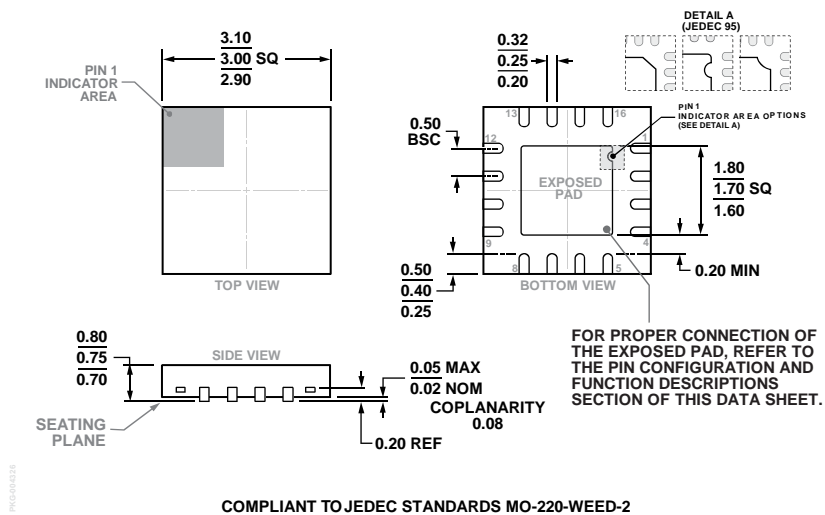

COMPLIANT TO JEDEC STANDARDS MO-220-WEED-2

Figure 88. 16-Lead Lead Frame Chip Scale Package [LFCSP]
 3 mm × 3 mm Body and 0.75 mm Package Height
 (CP-16-35)

Dimensions shown in millimeters

ORDERING GUIDE

Model ^{1,2}	Temperature Range	MSL Rating ³	Package Description ⁴	Package Option
ADL8104ACPZN	-40°C to +85°C	MSL3	16-Lead Lead Frame Chip Scale Package [LFCSP]	CP-16-35
ADL8104ACPZN-R7	-40°C to +85°C	MSL3	16-Lead Lead Frame Chip Scale Package [LFCSP]	CP-16-35
ADL8104-EVALZ			Evaluation Board	

¹ The ADL8104ACPZN, ADL8104ACPZN-R7, and ADL8104-EVALZ are RoHS compliant parts.
² When ordering the evaluation board only, reference the model number, ADL8104-EVALZ.
³ See the Absolute Maximum Ratings section for additional information.
⁴ The lead finish of the ADL8104ACPZN and ADL8104ACPZN-R7 is nickel palladium gold (NiPdAu).

Mouser Electronics

Authorized Distributor

Click to View Pricing, Inventory, Delivery & Lifecycle Information:

[Analog Devices Inc.:](#)

[ADL8104ACPZN](#) [ADL8104ACPZN-R7](#)