

Power Operational Amplifier



FEATURES

- High Voltage – 900V
- High Speed – 2100V/ μ s slew rate
- Low Noise – 5nV/ $\sqrt{\text{Hz}}$ @ 10 kHz (typical)
- Low Standby Mode Current – 4mA

APPLICATIONS

- Test Equipment
- Sonar Systems
- Industrial Instrumentation

DESCRIPTION

PA194 is a precision power amplifier that can provide a high-voltage, high-speed signal at a very low noise. It is ideal for applications where high speed analog precision is paramount for the operation of the system. Offered in an 8-pin Power SIP package, the device can handle up to 30W of continuous power dissipation.

Figure 1: Equivalent Schematic

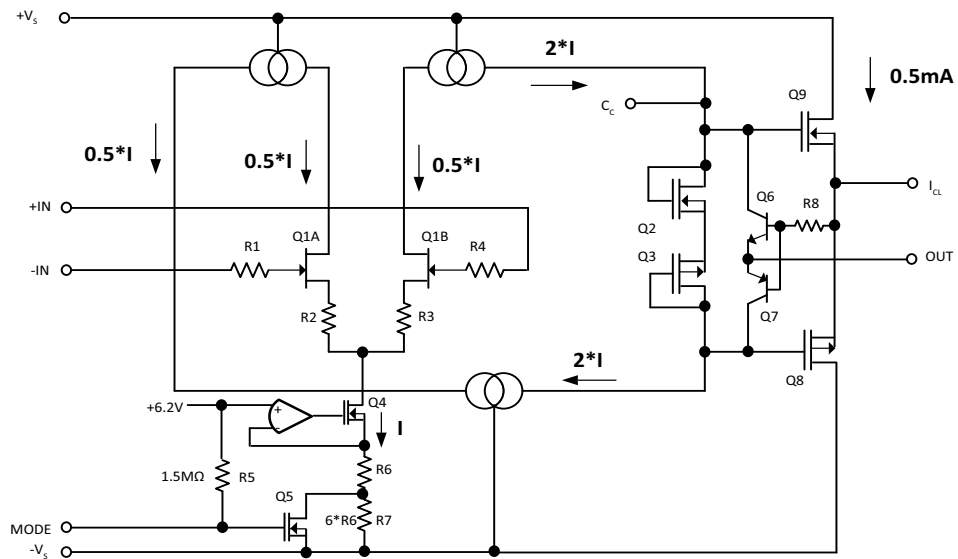

TYPICAL CONNECTION

Figure 2: Typical Connection

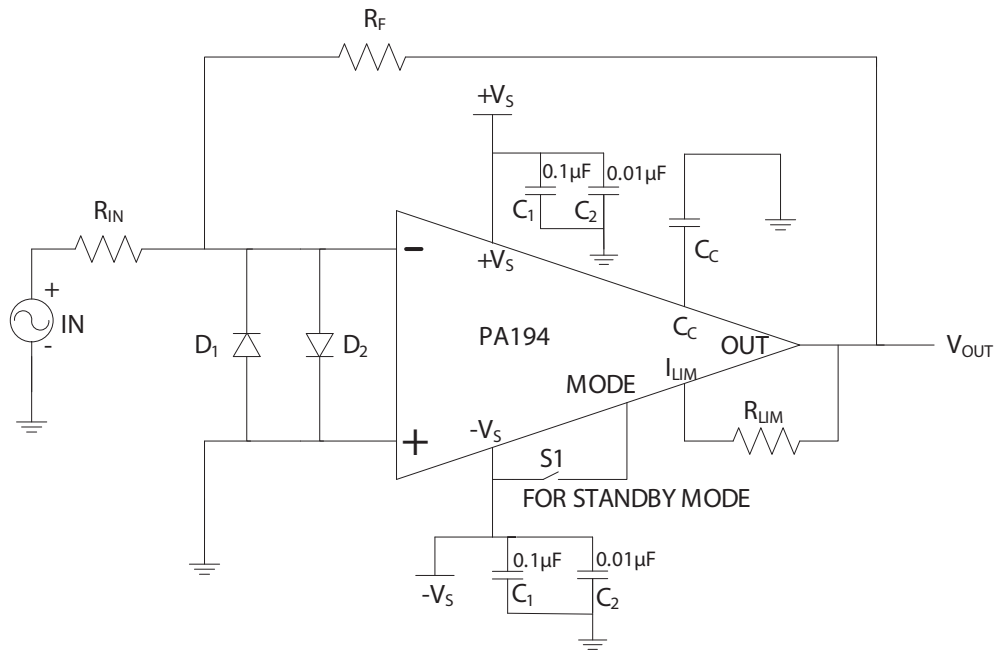

PINOUT AND DESCRIPTION TABLE

Figure 3: External Connections

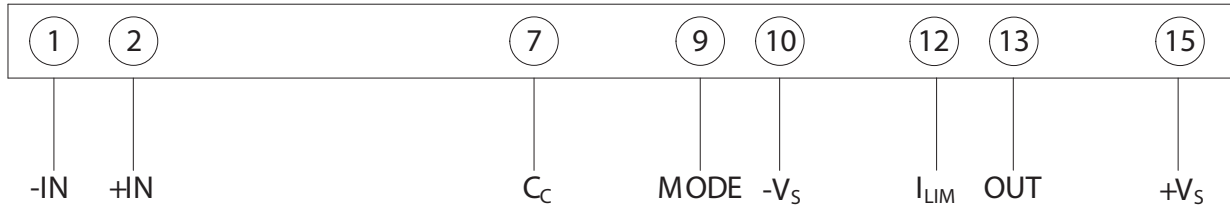

Pin Number	Name	Description
1	-IN	Inverting input
2	+IN	Non-inverting input
7	C_C	Compensation capacitor connection to ground
9	MODE	MODE = $-V_S$ -> Standby Mode, MODE = OPEN -> Normal Operation.
10	$-V_S$	Negative supply rail
12	I_{LIM}	Connect to the current limit resistor. Output current flows into/out of this pin through R_{LIM} . The output pin and the load are connected to the other side of R_{LIM} .
13	OUT	Output. Connect this pin to load and to the feedback resistors.
15	$+V_S$	Positive supply rail
3, 4, 5, 6, 8, 11, 14	NC	No Connection/No Pin

SPECIFICATIONS

Unless otherwise noted: $T_C = 25^\circ\text{C}$, $C_C = \text{open}$, $A_V = -100 \text{ V/V}$, MODE is open. DC input specifications are \pm value given. Power supply voltage is $\pm 300\text{V}$.

ABSOLUTE MAXIMUM RATINGS

Parameter	Symbol	Min	Max	Units
Supply Voltage, total	$+V_S$ to $-V_S$		900	V
Output Current, peak, within SOA	I_{OUT}		200	mA
Power Dissipation, internal, DC	P_D		30	W
Input Voltage, differential	$V_{IN}(\text{Diff})$	-20	20	V
Temperature, pin solder, 10s max.			260	$^\circ\text{C}$
Temperature, junction ¹	T_J		150	$^\circ\text{C}$
Temperature Range, storage		-55	+125	$^\circ\text{C}$
Operating Temperature Range, case	T_C	-40	+85	$^\circ\text{C}$

1. Long term operation at the maximum junction temperature will result in reduced product life. Derate internal power dissipation to achieve high MTTF.

INPUT

Parameter	Test Conditions	PA194			PA194A			Units
		Min	Typ	Max	Min	Typ	Max	
Offset Voltage, initial			0.5	5		*	*	mV
Offset Voltage vs. Temperature	0°C to 85°C		25			*		μV/°C
Offset Voltage vs. Supply			10	15		*	*	μV/V
Offset Voltage vs. Time			75			*		μV/kh
Bias Current, initial ¹			15	400		*	*	pA
Bias Current vs. Supply			4			*		pA/V
Offset Current, initial			8	200		*	*	pA
Input Resistance, DC			10 ¹¹			*		Ω
Input Capacitance			25			*		pF
Common Mode Voltage Range ²	V _S = ±450V	-V _S +40		+V _S -40	*		*	V
Common Mode Rejection, DC	V _{CM} = ±90V	92			*			dB
Integrated Noise	10 kHz BW, R _{IN} = 100 Ω		460			*		nV RMS
Noise Density	R _{IN} = 100 Ω, F = 10 kHz		4			*		nV/√Hz

1. Doubles for every 10°C of case temperature increase.
2. Although supply voltages can range up to ±450V the input pins cannot swing over this range. The input pins must be at least 40 V from either supply rail but not more than 450V from negative supply rail, -V_S. However, the inputs can be 860V from the positive supply rail, +V_S.

GAIN

Parameter	Test Conditions	PA194			PA194A			Units
		Min	Typ	Max	Min	Typ	Max	
Open Loop Gain @ 15 Hz	$R_L = 5\text{ k}\Omega$	96	110		*	*		dB
Gain Bandwidth Product @ 1 MHz	$R_L = 5\text{ k}\Omega$		140			*		MHz
Power Bandwidth	$R_L = 5\text{ k}\Omega$		800			*		kHz
Phase Margin, $A_V=100\text{ V/V}$	Full temp range		30			*		°

OUTPUT

Parameter	Test Conditions	PA194			PA194A			Units
		Min	Typ	Max	Min	Typ	Max	
Voltage Swing ¹	$I_{OUT}=70\text{mA,DC}$		$+V_S-12$	$+V_S-25$		*	*	V
Voltage Swing ¹	$I_{OUT}=70\text{mA,DC}$		$-V_S+22$	$-V_S+25$		*	*	V
Current, continuous, DC		100			*			mA
Slew Rate, $A_V = -100\text{ V/V}^2$			2100		1800	*		V/ μs
Settling Time to 0.1%	2V step		1			*		μs
Output Resistance	No load, DC, Closed loop		100			*		Ω

1. Please refer to Output Voltage Drop vs Frequency Plot
2. Ground heat tab for higher slew rate

POWER SUPPLY

Parameter	Test Conditions	PA194			PA194A			Units
		Min	Typ	Max	Min	Typ	Max	
Voltage		±50		±450	*		*	V
Current, quiescent (normal operation)		20	25	30	*	*	*	mA
Current, quiescent (standby mode)	Mode = -V _S		4			*		mA

THERMAL

Parameter	Test Conditions	PA194			PA194A			Units
		Min	Typ	Max	Min	Typ	Max	
Resistance, AC, junction to case ¹	Full temp range, F≥60Hz			3			*	°C/W
Resistance, DC, junction to case	Full temp range, F<60Hz			4.2			*	°C/W
Resistance, junction to air	Full temp range		30			*		°C/W
Temperature Range, case		-40		+85	*		*	°C

1. Rating applies if the output current alternates between both output transistors at a rate faster than 60 Hz.

TYPICAL PERFORMANCE GRAPHS

Figure 4: Small Signal Response, $C_C = 0pF$

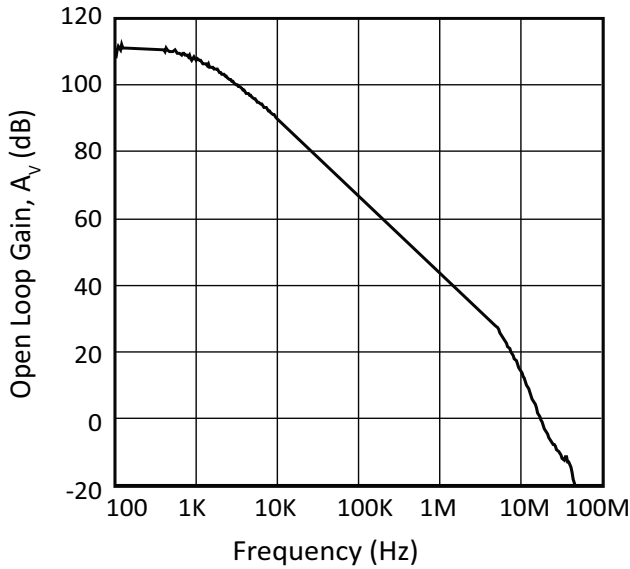

Figure 5: Phase Response, $C_C = 0pF$

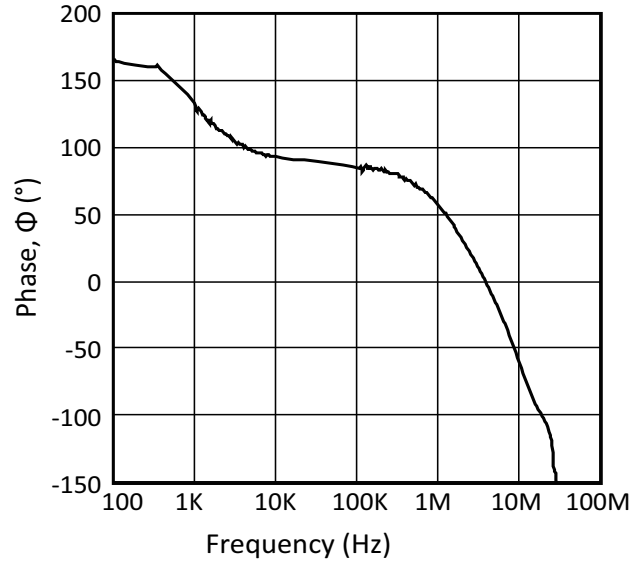

Figure 6: Positive Output Voltage Swing

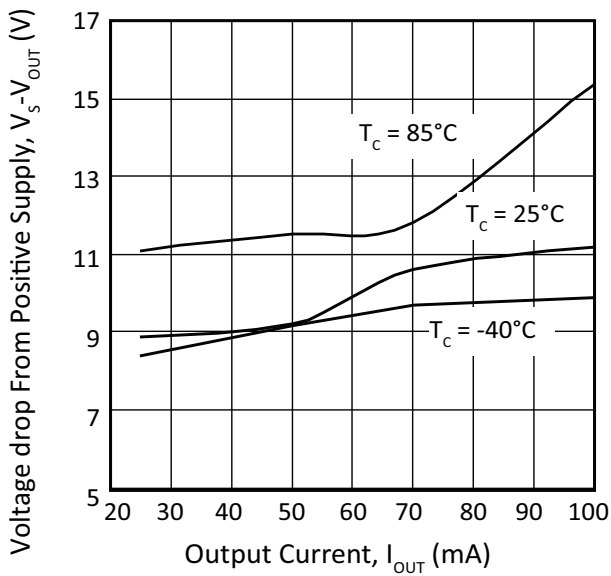

Figure 7: Negative Output Voltage Swing

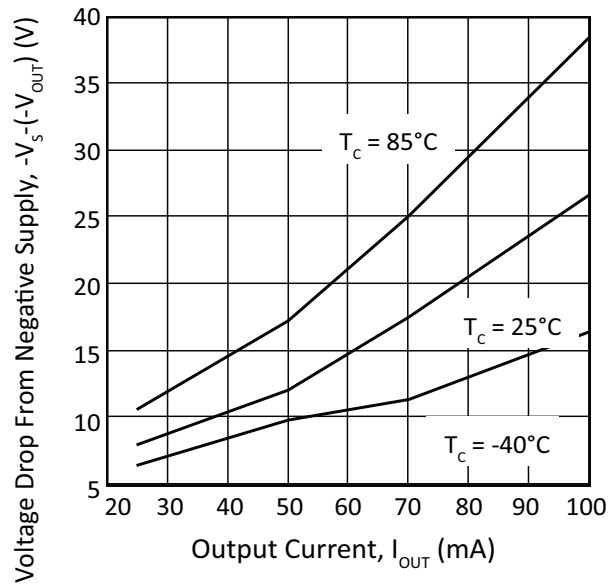

Figure 8: Power Response

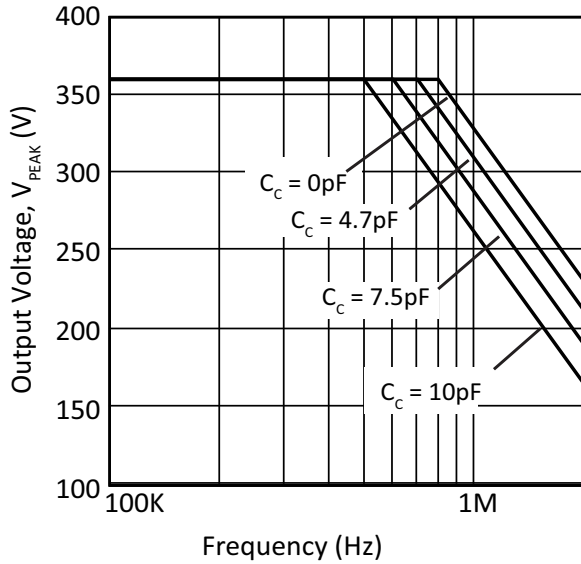

Figure 9: Small Signal Pulse Response

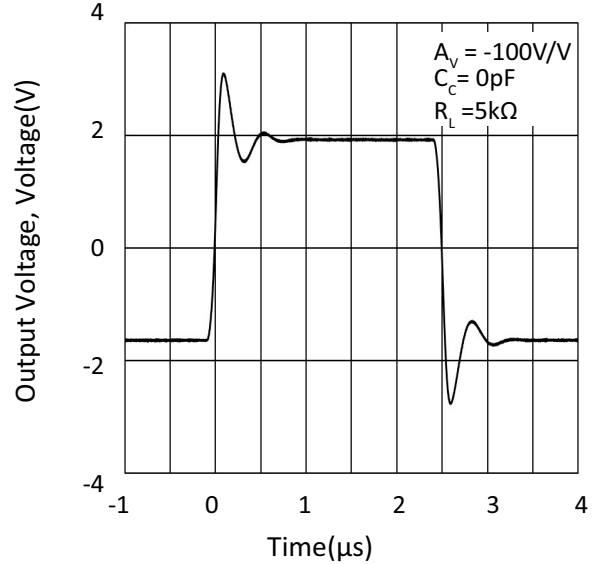

Figure 10: Quiescent Current I_Q vs. Supply, Normal Operation

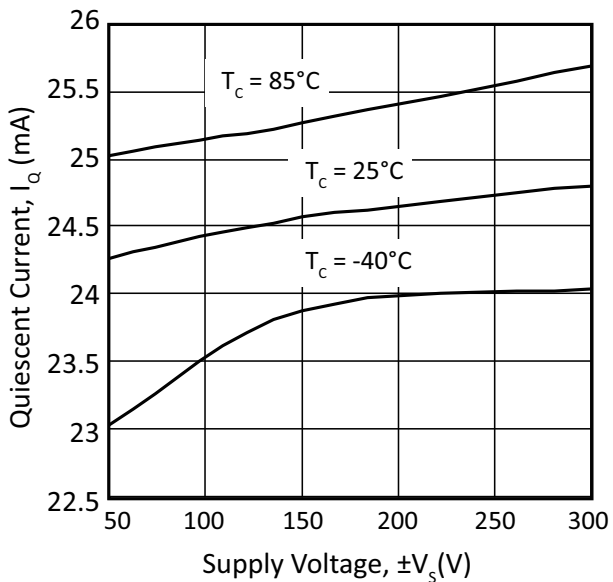

Figure 11: Quiescent I_Q vs. Supply, Standby Mode

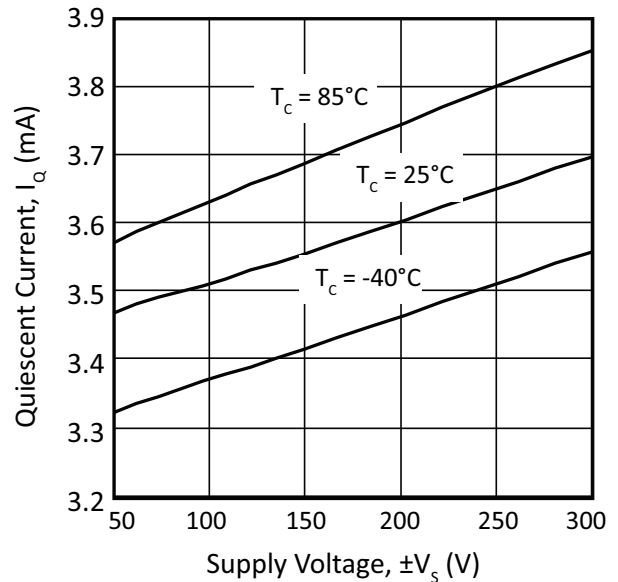

Figure 12: Input Noise

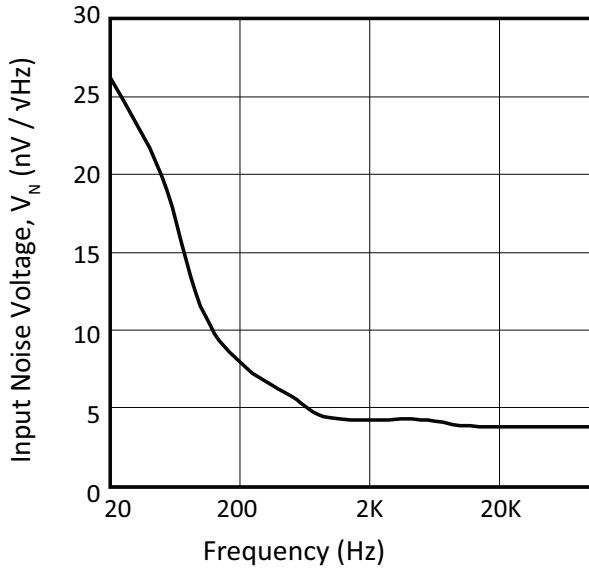

Figure 13: Slew Rate vs. Compensation Capacitor, $A_v = -100 \text{ V/V}$

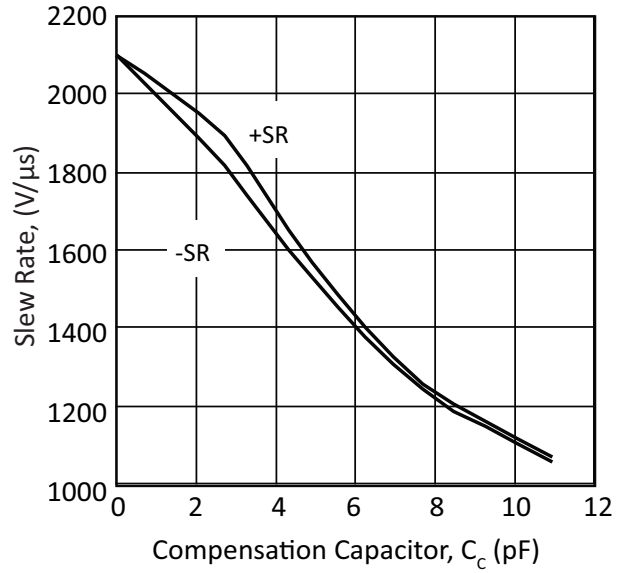

Figure 14: Slew Rate vs. Compensation Capacitor, $A_v = -20 \text{ V/V}$

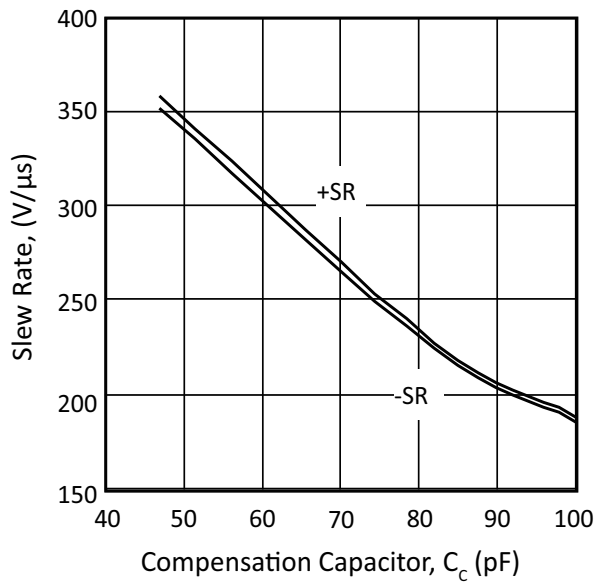
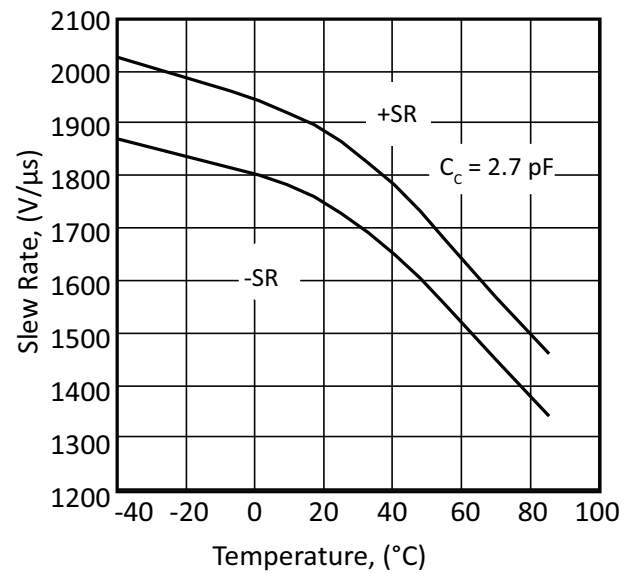

Figure 15: Slew Rate vs. Temperature, $A_v = -100 \text{ V/V}$



**Figure 16: Slew Rate vs. Temperature,
 $A_V = -20 \text{ V/V}$**

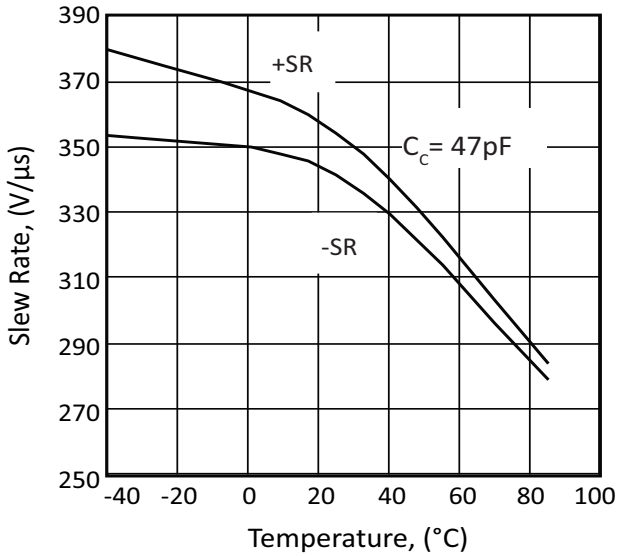

Figure 17: Current Limit

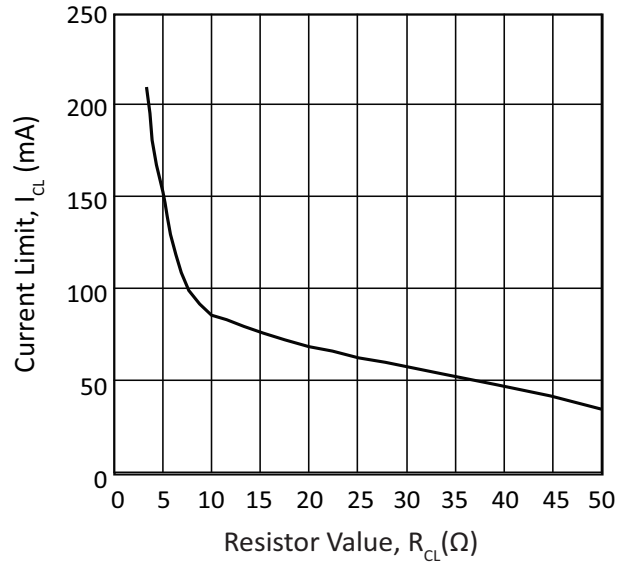

Figure 18: Power Supply Rejection

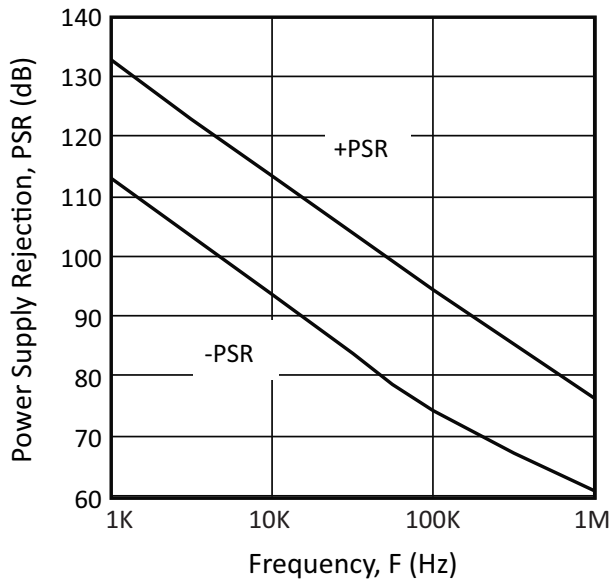
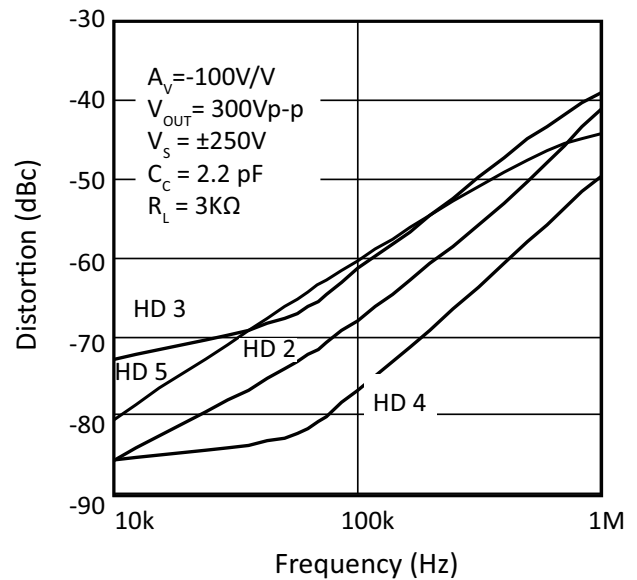
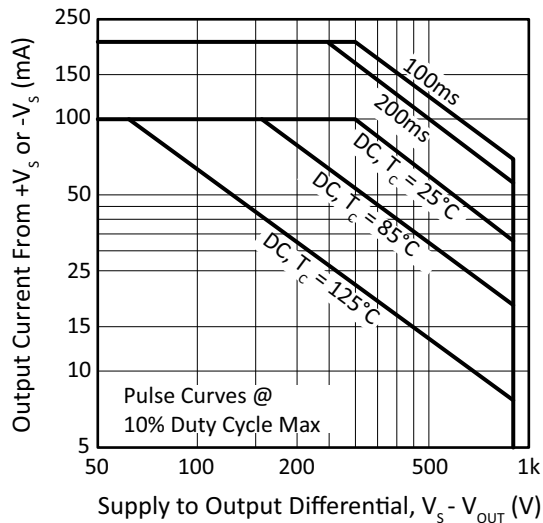

Figure 19: Harmonic Distortion



SAFE OPERATING AREA (SOA)

Figure 20: Safe Operating Area (SOA)



GENERAL:

Please read Application Note 1, “General Operating Considerations” which covers stability, supplies, heatsinking, mounting, current limit, SOA interpretation, and specification interpretation. Visit www.apexanalog.com for Apex Microtechnology’s complete Application Notes library, Technical Seminar Workbook, and Evaluation Kits.

INTERNAL POWER DISSIPATION AND HEAT SINK SELECTION

With the unique combination of high voltage and speed of the PA194, traditional formulas for heatsink selection will falsely lower the apparent power handling capability of this amplifier. To more accurately predict operating temperatures refer to Apex Microtechnology Applications Note 1, General Operating Considerations, paragraph 7. Find total quiescent power (PD_Q) by multiplying 0.030 by total supply voltage (+V_S-(-V_S)).

Calculate a heatsink rating which will maintain the case at 85°C or lower.

$$R_{\theta SA} = \frac{T_J - T_A}{PD + PD_Q} - 0.1 \frac{^{\circ}C}{W}$$

Where: T_C = maximum case temperature allowed

T_A = maximum ambient temperature encountered

Calculate a heat sink rating which will maintain output transistor junctions at 150°C or lower.

$$R_{\theta SA} = \frac{T_J - T_A - (PD - PD_{QOUT}) \cdot R_{\theta JC}}{PD + PD_Q} - 0.1 \frac{^{\circ}C}{W}$$

Where T_J = maximum junction temperature allowed.

R_{θJC} = AC or DC thermal resistance from the specification table

Use the larger heatsink of these two calculations

CURRENT LIMIT

For proper operation, the current limit resistor (R_{LIM}) must be connected as described in the pin out description table. The value of the current limit resistor is calculated as follows; with the minimum practical value of 3.9 Ω.

$$R_{LIM}(\Omega) = \frac{0.7}{I_{LIM} (A) - 0.021}$$

PHASE COMPENSATION

GAIN	C _C
≥ 100	0pF
≥ 50	8.2pF
≥ 20	47pF

Note: C_C should be rated for full supply voltage.

MODE PIN OPERATION

The PA194 has an integrated standby-mode which reduces the quiescent current to 4mA when the mode pin (pin # 9) is connected to the negative supply (-V_S). The standby mode helps in power saving when the amplifier is not in normal operation.

INPUT PROTECTION

Although the PA194 can withstand differential input voltages up to ±20V, additional external protection is recommended. In most applications 1N4148 or 1N914 signal diodes are sufficient (D1, D2, in Figure 2). This will clamp the input differential voltage to ±0.7V. This is sufficient overdrive to produce maximum power bandwidth. Note that this protection does not automatically protect the amplifier from excessive common mode input voltages.

STABILITY

The PA194 is stable for a resistive load at gains of 100 or more without any compensation capacitor. The C_C pin should be left open. Please note that PCB trace can add several pF of parasitic capacitance to the compensation pin which can reduce the slew rate of the amplifier. For lower gains, or for larger capacitive loads, a compensation capacitor should be used. The compensation capacitor, C_C, in the typical connections diagram in Figure 2 must be rated at 1000V working voltage and mounted closely to pin 7 to prevent oscillation.

The PA194 is optimized to be stable at a gain of 20 or higher. It is possible to obtain higher slew rate at a lower gain by taking advantage of the noise gain compensation techniques. Refer to application note AN19 for more details on noise gain compensation techniques.

POWER SUPPLY PROTECTION

Unidirectional zener diode transient suppressors are recommended as protection on the supply pins. The zeners clamp transients to voltages within the power supply rating and also clamp power supply reversals to ground. Whether the zeners are used or not, the system power supply should be evaluated for transient performance including power-on overshoot and power-off polarity reversal as well as line regulation. Conditions which can cause open circuits or polarity reversals on either power supply rail should be avoided or protected against. Reversals or opens on the negative supply rail is known to induce input stage failure. Unidirectional transzorbis prevent this, and it is desirable that they be both electrically and physically as close to the amplifier as possible. Refer application note AN01 for additional information on power supply protection.

EXTERNAL COMPONENTS

The compensation capacitor C_C must be rated for the total supply voltage. An NPO (COG) capacitor rated 1kV is recommended.

Also of equal importance are the voltage rating and voltage coefficient of the gain setting feedback resistor. Typical voltage ratings of low wattage resistors are 150 to 250V. Please note that voltages of up to 900 V can appear across the feedback resistor.

When selecting external components like feedback resistor and current limit resistor, use low reactance type resistors. Inductance from wire-wound type resistors can cause instability in the amplifier and reduce the slew rate of the amplifier

POWER SUPPLY BYPASSING

Bypass capacitors to power supply terminals $+V_S$ and $-V_S$ must be connected physically close to the pins to prevent local parasitic oscillation in the output stage of the PA194. Use high quality ceramic capacitors (X7R) 0.01 μ F or greater for high frequency noise from the power supply. Ceramic bypass capacitors of 0.1 μ F and 1 μ F or greater are recommended for the $+V_S$ and V_S pins. Ensure that the bypass capacitors are rated for total supply voltage from $+V_S$ to $-V_S$.

CAUTION

The operating voltages of the PA194 are potentially lethal. During circuit design develop a functioning circuit at the lowest possible voltages. Clip test leads should be used for “hands off” measurements while troubleshooting.

PACKAGE OPTIONS

Part Number	Apex Package Style	Description
PA194	GN	8-pin Power SIP

PACKAGE STYLE GN

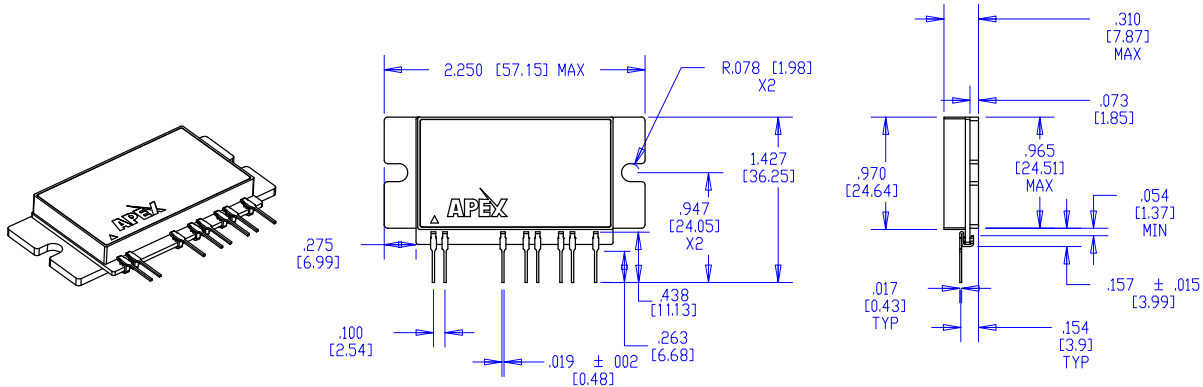

1. Dimensions are in inches.
2. Triangle on lid denotes pin 1.
3. Pins: Alloy 510 phosphor bronze plated with matte tin (150 - 300u") over nickel (50 u" max.) underplate.
4. Paackage: Vectra liquid crystal polymer, black.
5. Epoxy-sealed & untrasonically welded non-hermetic package.

NEED TECHNICAL HELP? CONTACT APEX SUPPORT!

For all Apex Microtechnology product questions and inquiries, call toll free 800-546-2739 in North America. For inquiries via email, please contact apex.support@apexanalog.com. International customers can also request support by contacting their local Apex Microtechnology Sales Representative. To find the one nearest to you, go to www.apexanalog.com

IMPORTANT NOTICE

Apex Microtechnology, Inc. has made every effort to insure the accuracy of the content contained in this document. However, the information is subject to change without notice and is provided "AS IS" without warranty of any kind (expressed or implied). Apex Microtechnology reserves the right to make changes without further notice to any specifications or products mentioned herein to improve reliability. This document is the property of Apex Microtechnology and by furnishing this information, Apex Microtechnology grants no license, expressed or implied under any patents, mask work rights, copyrights, trademarks, trade secrets or other intellectual property rights. Apex Microtechnology owns the copyrights associated with the information contained herein and gives consent for copies to be made of the information only for use within your organization with respect to Apex Microtechnology integrated circuits or other products of Apex Microtechnology. This consent does not extend to other copying such as copying for general distribution, advertising or promotional purposes, or for creating any work for resale.

APEX MICROTECHNOLOGY PRODUCTS ARE NOT DESIGNED, AUTHORIZED OR WARRANTED TO BE SUITABLE FOR USE IN PRODUCTS USED FOR LIFE SUPPORT, AUTOMOTIVE SAFETY, SECURITY DEVICES, OR OTHER CRITICAL APPLICATIONS. PRODUCTS IN SUCH APPLICATIONS ARE UNDERSTOOD TO BE FULLY AT THE CUSTOMER OR THE CUSTOMER'S RISK.

Apex Microtechnology, Apex and Apex Precision Power are trademarks of Apex Microtechnology, Inc. All other corporate names noted herein may be trademarks of their respective holders.

Mouser Electronics

Authorized Distributor

Click to View Pricing, Inventory, Delivery & Lifecycle Information:

[Apex Microtechnology:](#)

[PA194](#)