

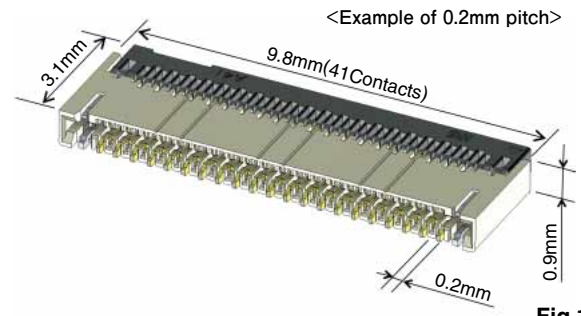

Maximizes board space by utilizing its low-profile, and narrow pitch and depth



**Fig.1**

**Features**

**1. Maximizes board space**

The combination of a fine pitch of 0.2mm/0.25mm and narrow depth of 3.1mm saves board space. (Fig.1)

**2. High FPC retention force**

• Chucking metal at both side of the connector provides high FPC retention force. (Fig.2)

Being movable, the chucking metal allows this connector to accept horizontal FPC insertions; it provides a clear tactile click and increased retention force when the FPC is inserted.

**3. High reliability top and bottom contact structure**

• Top and bottom spring contacts follows up-and-down movement of the FPC to provide secure connectivity. (Fig.3)

**4. Supports high-speed transmissions**

• Excellent impedance characteristics enables high speed transmission.

By utilizing differential pairs of identical contacts (even-even contacts or odd-odd contacts) these connectors are able to provide superb transmission characteristics and have achieved compliance with the eDP (ver.1.3), MIPI (D-PHY) and USB3.0 standards. (Fig.4)

**5. Environmentally friendly**

• Halogen-free

All materials and substances used to produce this product comply with Halogen-free standards.

\*Defined in accordance with IEC 61249-2-21.

Br : 900 ppm max, Cl : 900 ppm max, Br+Cl : 1500 ppm max.

**Multi-functional chucking metal**

[FPC in place]

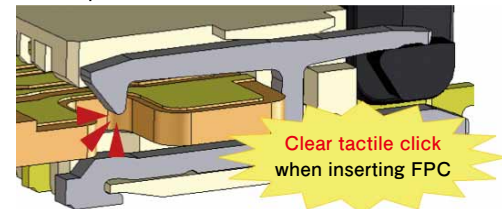

[Locked]

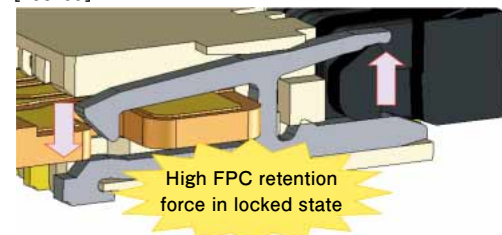

**Fig.2**

**High connection reliability with bottom spring contact.**  
When bottom contact is used, FPC is lifted upward

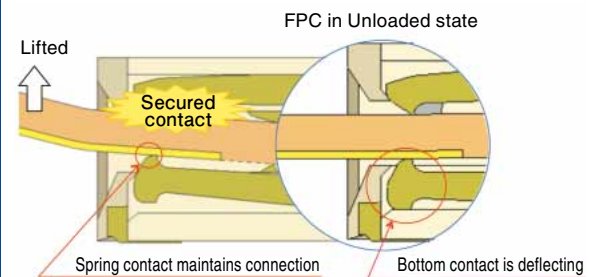

**Fig.3**

**FH58 Differential impedance 130ps rise time (20-80%)**

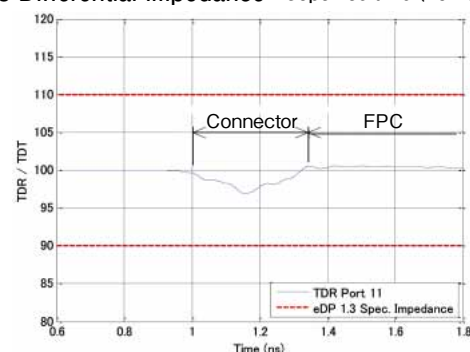

**Fig.4**

## Product Specifications

Rating	Current rating 0.2A	Operating Temperature Range -55 to +85°C (Note 1)	Storage Temperature Range -10 to +50°C (Note 2)
	Voltage rating AC30Vrms		

Recommended FPC SPC	t=0.2±0.02 Gold plated
---------------------	------------------------

Items	Specifications	Conditions
1. Insulation Resistance	50MΩ min	100V DC
2. Withstanding Voltage	No flashover or insulation breakdown	90Vrms AC/1min
3. Contact Resistance	300mΩ max (0.2mm pitch products) 200mΩ max (0.25mm pitch products) *Including FPC conductor resistance	1mA AC
4. Mechanical Operation	Contact resistance : 300mΩ max (0.2 mm pitch products) 200mΩ max (0.25 mm pitch products) No damages, cracks and looseness of parts	10 times insertions and extractions.
5. Vibration Resistance	Contact resistance : 300mΩ max (0.2 mm pitch products) 200mΩ max (0.25 mm pitch products) No damages, cracks and looseness of parts	Frequency : 10 to 55 Hz, half amplitude : 0.75 mm, for 10 cycles in 3 axial directions.
6. Shock Resistance	No electrical discontinuity of 1μs or longer Contact resistance : 300mΩ max (0.2 mm pitch products) 200mΩ max (0.25 mm pitch products) No damages, cracks and looseness of parts	Acceleration: 981 m/s <sup>2</sup> , duration 6 ms, half-sine wave, at 3 times in 3 axial directions
7. Moisture Resistance in steady state	Contact resistance : 300mΩ max (0.2 mm pitch products) 200mΩ max (0.25 mm pitch products) Insulation resistance : 50MΩ min No damages, cracks and looseness of parts	96 hours at 40°C and humidity of 90 to 95%
8. Temperature Cycles	Contact resistance : 300mΩ max (0.2 mm pitch products) 200mΩ max (0.25 mm pitch products) Insulation resistance : 50MΩ min No damages, cracks and looseness of parts	Temperature : -55→+15 to +35→+85→+15 to +35°C Time : 30 → 2 to 3 → 30 → 2 to 3 minutes 5 cycles with above conditions
9. Resistance to Soldering Heat	No deformation of case or excessive looseness of the terminals	Reflow : Recommended Temperature Profile Manual soldering : 350±10°C, 5 seconds

Note 1 : Including temperature rise caused by current flow.

Note 2 : The term "storage" refers to the long-term storage condition of unused products before PCB mounting.  
For no-electrification state after PCB mounting, the operating temperature and humidity are applied.

## Materials / Finish

Parts	Material	Treatment	UL Regulation
Insulator	LCP	Beige	UL94V-0
	PA	Black	
Contact	Phosphor bronze	Nickel barrier gold plated	—
Metal fitting	Phosphor bronze	Pure tin reflow plated	

## Part Number Structure

Refer to the chart below when determining the product specifications from the product number.  
Please select from the product numbers listed in this catalog when placing orders.

**FH 58 M A - 41S - 0.25 SHW (99)**

①    ②    ③    ④                    ⑤                    ⑥                    ⑦                    ⑧

① Series Name : FH	⑤ No. of Contacts : 31,35,41,51
② Series No. : 58	⑥ Contact Pitch : 0.2mm, 0.25mm
③ No symbol : 0.2mm pitch M : 0.25mm pitch	⑦ Terminal Type SHW...SMT horizontal staggered mounting type
④ Actuator Type No symbol : standard-type actuator A : long-type actuator	⑧ Specifications None : Regular(5000 per reel) (99) : 500 per reel

## Connector Dimensions

### FH58(M) Series (0.2mm/0.25mm pitch, standard type actuator)

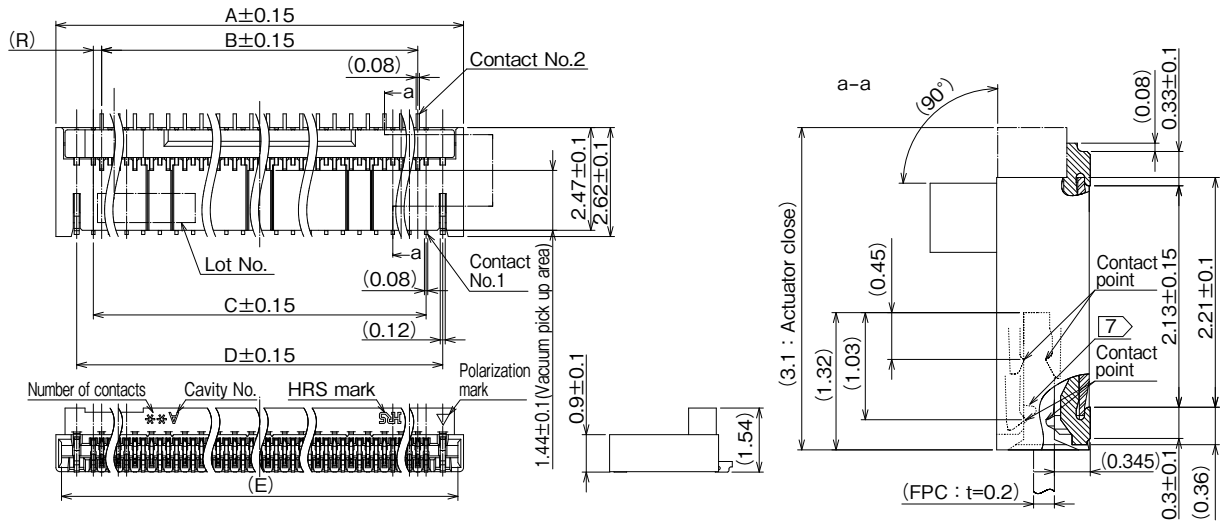

**Note**

- 1 : The dimension in parentheses are for reference.
- 2 : Lead co-planarity including reinforced chucking metals shall be 0.1 max.
- 3 : To be delivered with tape and reel packages.  
See the packaging specifications for details.
- 4 : Note that preventive hole for sink mark or slit could be added for improvement.
- 5 : The quality remains good, even with the dark spots, which could occasionally occur on molded plastic.
- 6 : This product satisfies halogen free requirements defined as 900ppm maximum chlorine, 900ppm maximum bromine, and 1500ppm maximum total of chlorine and bromine.
- 7 : Shows hook part of the chucking metal.

Units : mm

Part No.	HRS No.	No. of Contacts	A	B	C	D	E	R
FH58-13S-0.2SHW(**)	—	13	4.2	2	2.4	3.2	3.93	0.2
FH58-21S-0.2SHW(**)	—	21	5.8	3.6	4	4.8	5.53	
FH58-23S-0.2SHW(**)	—	23	6.2	4	4.4	5.2	5.93	
FH58-31S-0.2SHW(**)	580-3806-9 **	31	7.8	5.6	6	6.8	7.53	
FH58-35S-0.2SHW(**)	580-3810-0 **	35	8.6	6.4	6.8	7.6	8.33	
FH58-41S-0.2SHW(**)	580-3801-5 **	41	9.8	7.6	8	8.8	9.53	
FH58-45S-0.2SHW(**)	—	45	10.6	8.4	8.8	9.6	10.33	
FH58-51S-0.2SHW(**)	580-3807-0 **	51	11.8	9.6	10	10.8	11.53	
FH58M-7S-0.25SHW(**)	—	7	3.5	1	1.5	2.5	3.23	0.25
FH58M-11S-0.25SHW(**)	—	11	4.5	2	2.5	3.5	4.23	
FH58M-21S-0.25SHW(**)	—	21	7	4.5	5	6	6.73	
FH58M-31S-0.25SHW(**)	—	31	9.5	7	7.5	8.5	9.23	
FH58M-41S-0.25SHW(**)	—	41	12	9.5	10	11	11.73	

**FH58(M)A Series (0.2mm/0.25mm pitch, long actuator type)**

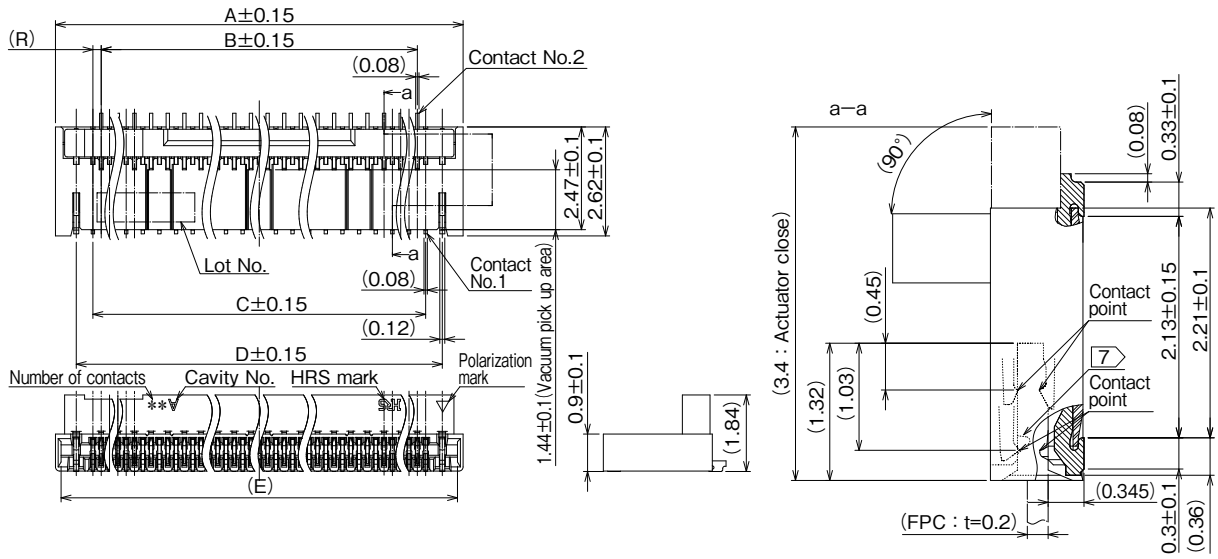

**Note**

- 1 : The dimension in parentheses are for reference.
- 2 : Lead co-planarity including reinforced chucking metals shall be 0.1 max.
- 3 : To be delivered with tape and reel packages.  
See the packaging specifications for details.
- 4 : Note that preventive hole for sink mark or slit could be added for improvement.
- 5 : The quality remains good, even with the dark spots, which could occasionally occur on molded plastic.
- 6 : This product satisfies halogen free requirements defined as 900ppm maximum chlorine, 900ppm maximum bromine, and 1500ppm maximum total of chlorine and bromine.
- 7 : Shows hook part of the chucking metal.

Units : mm

Part No.	HRS No.	No. of Contacts	A	B	C	D	E	R
FH58A-61S-0.2SHW(**)	—	61	13.8	11.6	12	12.8	13.53	0.2
FH58A-71S-0.2SHW(**)	—	71	15.8	13.6	14	14.8	15.53	
FH58MA-45S-0.25SHW(**)	—	45	13	10.5	11	12	12.73	0.25
FH58MA-51S-0.25SHW(**)	—	51	14.5	12	12.5	13.5	14.23	
FH58MA-61S-0.25SHW(**)	—	61	17	14.5	15	16	16.73	
FH58MA-71S-0.25SHW(**)	—	71	19.5	17	17.5	18.5	19.23	

**FH58(A) Series (P=0.2mm pitch, standard/long type actuator)**

**◆Recommended PCB Mounting Pattern**

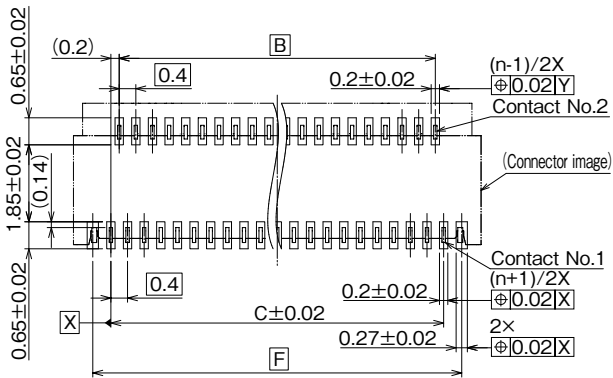

**◆Recommended Stencil Pattern**

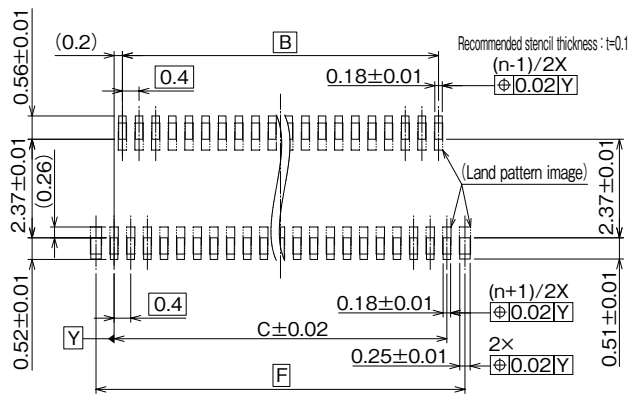

Note 8 : 'n' shows the number of contacts.

**◆Recommended Dimensions of PCB Mounting Pattern and Stencil Pattern**

Units : mm

Part No.	HRS No.	No. of Contacts	B	C	F
FH58-13S-0.2SHW(**)	—	13	2	2.4	3.27
FH58-21S-0.2SHW(**)	—	21	3.6	4	4.87
FH58-23S-0.2SHW(**)	—	23	4	4.4	5.27
FH58-31S-0.2SHW(**)	580-3806-9 **	31	5.6	6	6.87
FH58-35S-0.2SHW(**)	580-3810-0 **	35	6.4	6.8	7.67
FH58-41S-0.2SHW(**)	580-3801-5 **	41	7.6	8	8.87
FH58-45S-0.2SHW(**)	—	45	8.4	8.8	9.67
FH58-51S-0.2SHW(**)	580-3807-0 **	51	9.6	10	10.87
FH58A-61S-0.2SHW(**)	—	61	11.6	12	12.87
FH58A-71S-0.2SHW(**)	—	71	13.6	14	14.87

**FH58M(A) Series (P=0.25mm pitch, standard/long type actuator)**

**◆Recommended PCB Mounting Pattern**

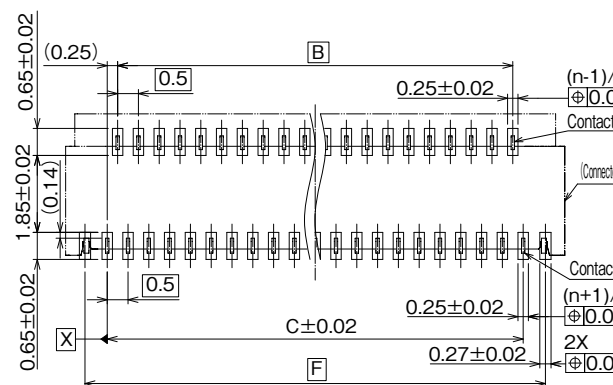

**◆Recommended Stencil Pattern**

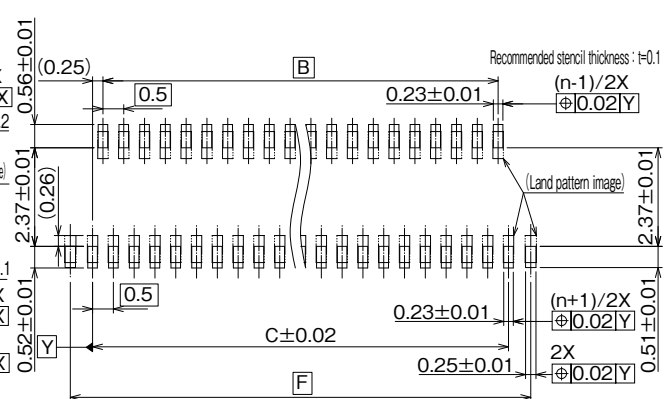

Note 8 : 'n' shows the number of contacts.

**◆Recommended Dimensions of PCB Mounting Pattern and Stencil Pattern**

Units : mm

Part No.	HRS No.	No. of Contacts	B	C	F
FH58M-7S-0.25SHW(**)	—	7	1	1.5	2.52
FH58M-11S-0.25SHW(**)	—	11	2	2.5	3.52
FH58M-21S-0.25SHW(**)	—	21	4.5	5	6.02
FH58M-31S-0.25SHW(**)	—	31	7	7.5	8.52
FH58M-41S-0.25SHW(**)	—	41	9.5	10	11.02
FH58MA-45S-0.25SHW(**)	—	45	10.5	11	12.02
FH58MA-51S-0.25SHW(**)	—	51	12	12.5	13.52
FH58MA-61S-0.25SHW(**)	—	61	14.5	15	16.02
FH58MA-71S-0.25SHW(**)	—	71	17	17.5	18.52

**FH58(A) Series (P=0.2mm pitch, standard/long type actuator)**

**◆Recommended FPC Dimensions**

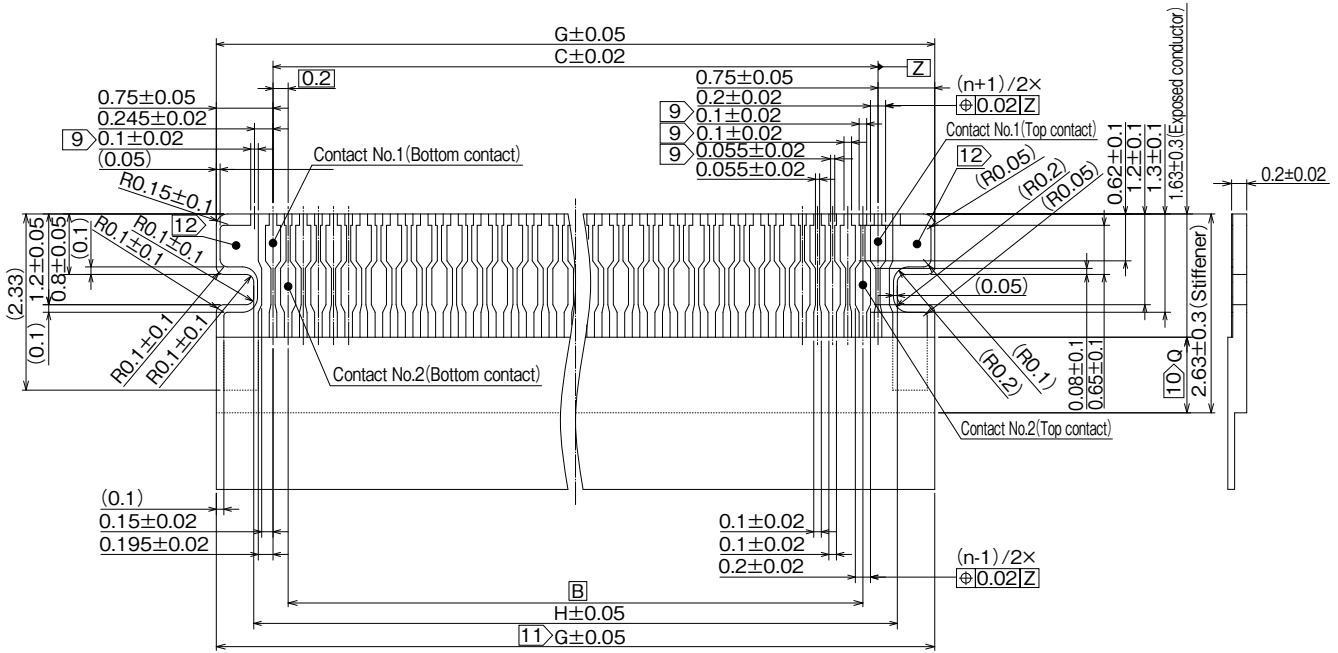

- Note 9 Shows recommended dimensions when lead for plating is required.
- Note 10 Dimension Q must be 0.5mm minimum.
- Note 11 Indicated tolerance is applicable to the exposed conductor.
- Note 12 Both end sides of contact pad on FPC cannot be used for signal transmission.

**◆Recommended FPC Pattern Dimensions**

Units : mm

Part No.	HRS No.	No. of Contacts	B	C	G	H
FH58-13S-0.2SHW(**)	—	13	2	2.4	3.9	2.91
FH58-21S-0.2SHW(**)	—	21	3.6	4	5.5	4.51
FH58-23S-0.2SHW(**)	—	23	4	4.4	5.9	4.91
FH58-31S-0.2SHW(**)	580-3806-9 **	31	5.6	6	7.5	6.51
FH58-35S-0.2SHW(**)	580-3810-0 **	35	6.4	6.8	8.3	7.31
FH58-41S-0.2SHW(**)	580-3801-5 **	41	7.6	8	9.5	8.51
FH58-45S-0.2SHW(**)	—	45	8.4	8.8	10.3	9.31
FH58-51S-0.2SHW(**)	580-3807-0 **	51	9.6	10	11.5	10.51
FH58A-61S-0.2SHW(**)	—	61	11.6	12	13.5	12.51
FH58A-71S-0.2SHW(**)	—	71	13.6	14	15.5	14.51

**◆FPC Configuration (Reference example)**

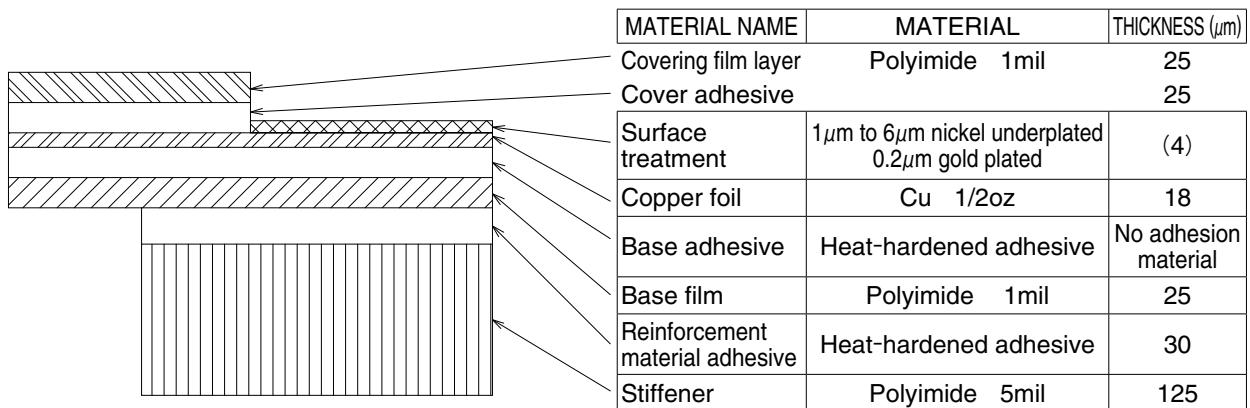

**FH58M(A) Series (P=0.25mm pitch, standard/long type actuator)**

**◆ Recommended FPC Dimensions**

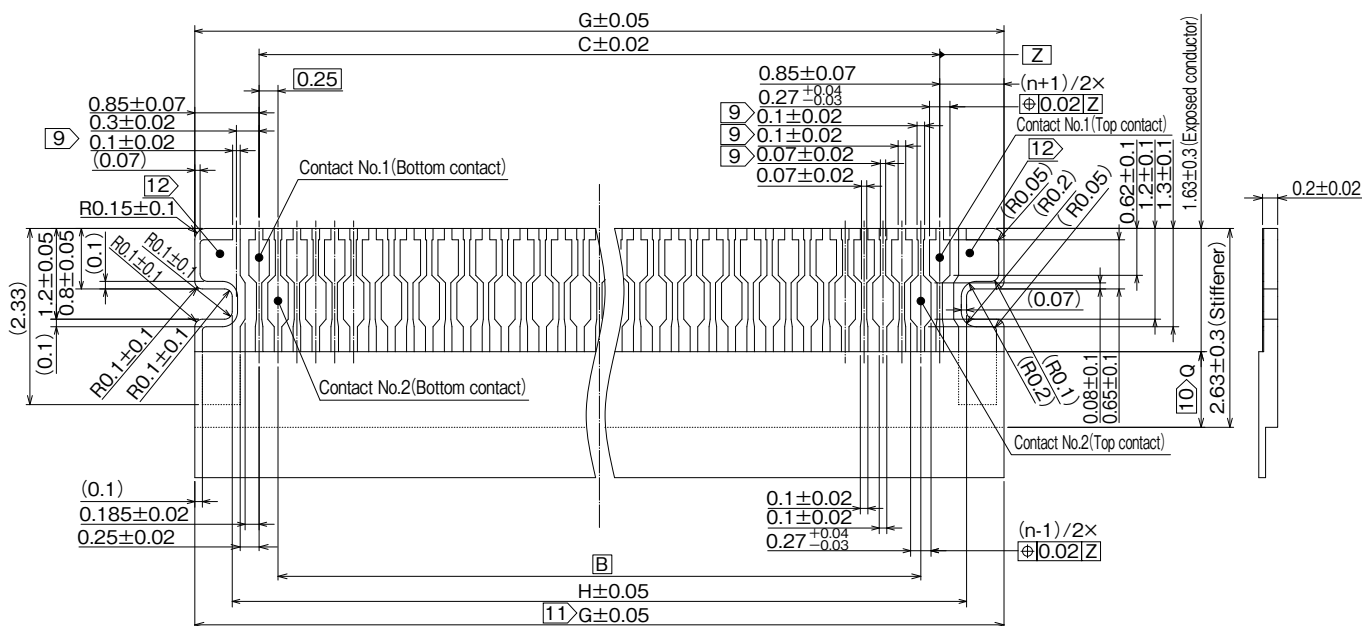

- Note 9 Shows recommended dimensions when lead for plating is required.
- Note 10 Dimension Q must be 0.5 mm minimum.
- Note 11 Indicated tolerance is applicable to the exposed conductor.
- Note 12 Both end sides of contact pad on FPC cannot be used for signal transmission.

**◆ Recommended FPC Pattern Dimensions**

Units : mm

Part No.	HRS No.	No. of Contacts	B	C	G	H
FH58M-7S-0.25SHW(**)	—	7	1	1.5	3.2	2.21
FH58M-11S-0.25SHW(**)	—	11	2	2.5	4.2	3.21
FH58M-21S-0.25SHW(**)	—	21	4.5	5	6.7	5.71
FH58M-31S-0.25SHW(**)	—	31	7	7.5	9.2	8.21
FH58M-41S-0.25SHW(**)	—	41	9.5	10	11.7	10.71
FH58MA-45S-0.25SHW(**)	—	45	10.5	11	12.7	11.71
FH58MA-51S-0.25SHW(**)	—	51	12	12.5	14.2	13.21
FH58MA-61S-0.25SHW(**)	—	61	14.5	15	16.7	15.71
FH58MA-71S-0.25SHW(**)	—	71	17	17.5	19.2	18.21

**◆ FPC Construction (Recommended Specifications)**

MATERIAL NAME	MATERIAL	THICKNESS (μm)
Covering film layer	Polyimide 1mil	25
Cover adhesive		25
Surface treatment	1μm to 6μm nickel underplated 0.2μm gold plated	(4)
Copper foil	Cu 1oz	35
Base adhesive	Heat-hardened adhesive	25
Base film	Polyimide 1mil	25
Reinforcement material adhesive	Heat-hardened adhesive	40
Stiffener	Polyimide 3mil	75

**◆ Note**

- This specification is recommendation for the construction of the FH58/FH58M series FPC (t=0.2±0.02 mm)
- For details about the construction, please contact FPC manufactures.

### FH58(M)(A) Series (0.2mm/0.25mm pitch, standard/long type actuator)

#### ◆Packaging Specifications

##### ●Embossed Carrier Tape Dimensions

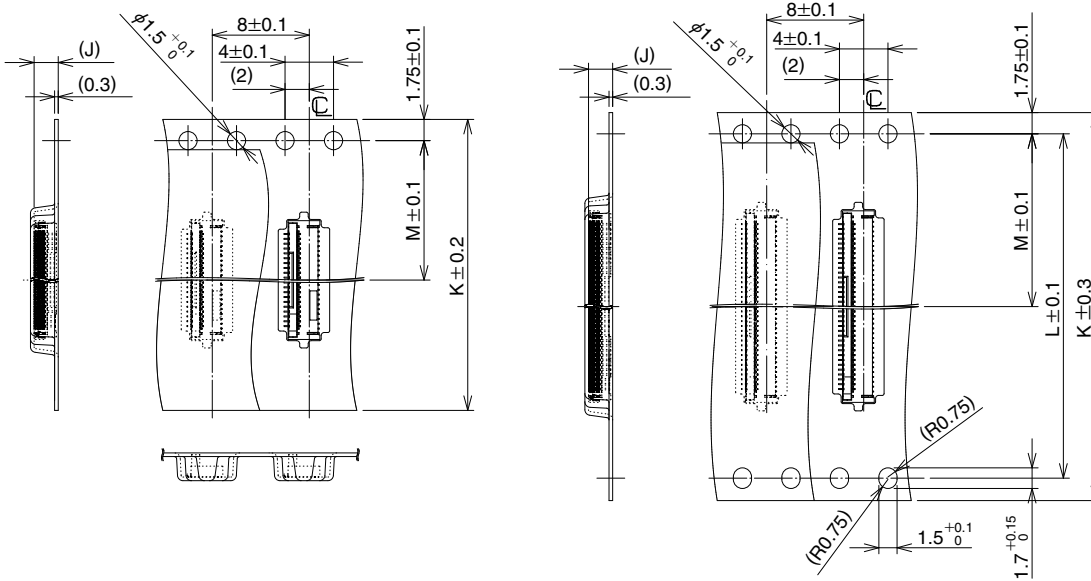

##### ●Reel Dimensions

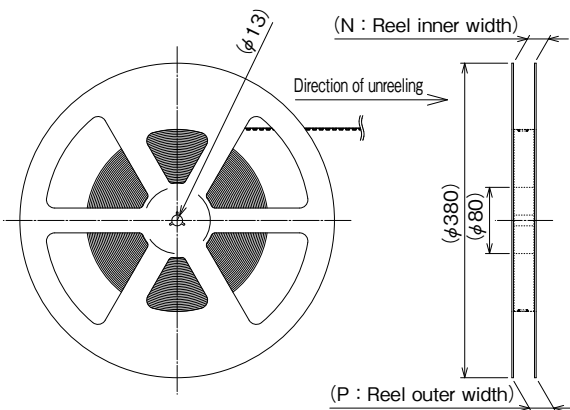

##### ●Leader, Trailer Dimensions

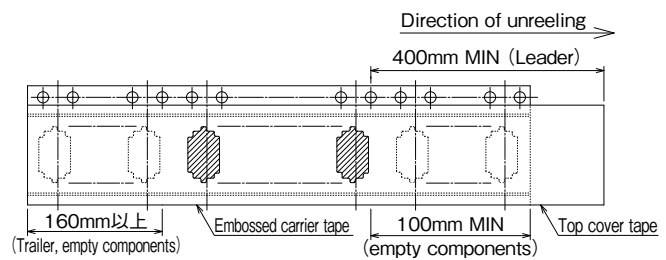

Units : mm

Part No.	HRS No.	No. of Contacts	J	K	L	M	N	P
FH58-13S-0.2SHW(**)	—	13	1.69	16	—	7.5	17.4	21.4
FH58-21S-0.2SHW(**)	—	21						
FH58-23S-0.2SHW(**)	—	23						
FH58-31S-0.2SHW(**)	580-3806-9 **	31						
FH58-35S-0.2SHW(**)	580-3810-0 **	35						
FH58-41S-0.2SHW(**)	580-3801-5 **	41						
FH58-45S-0.2SHW(**)	—	45						
FH58-51S-0.2SHW(**)	580-3807-0 **	51	1.99	24	11.5	25.4	29.4	
FH58A-61S-0.2SHW(**)	—	61						
FH58A-71S-0.2SHW(**)	—	71	1.69	32	28.4	14.2	33.4	37.4
FH58M-7S-0.25SHW(**)	—	7						
FH58M-11S-0.25SHW(**)	—	11						
FH58M-21S-0.25SHW(**)	—	21						
FH58M-31S-0.25SHW(**)	—	31						
FH58M-41S-0.25SHW(**)	—	41						
FH58MA-45S-0.25SHW(**)	—	45						
FH58MA-51S-0.25SHW(**)	—	51	1.99	44	40.4	20.2	45.4	49.4
FH58MA-61S-0.25SHW(**)	—	61						
FH58MA-71S-0.25SHW(**)	—	71						



## ◆ Temperature Profile

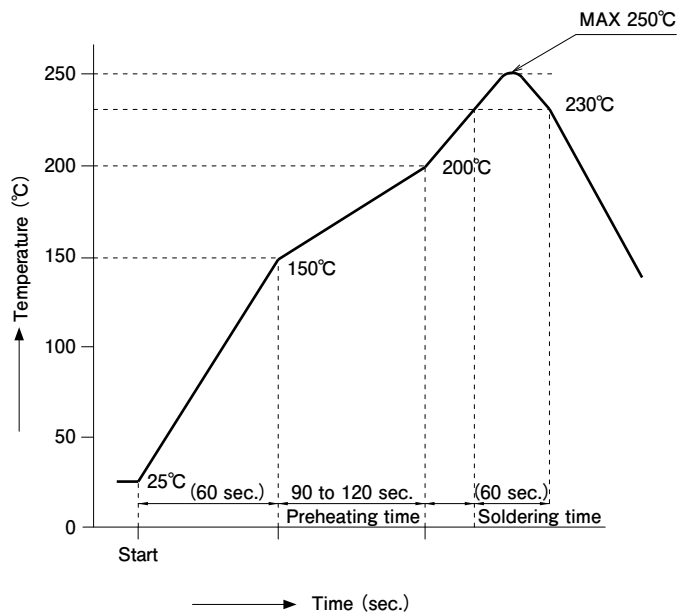

### Applicable Conditions

- Reflow method : IR/Hot air
- Reflow environment : Room air
- Solder : Paste type Sn/3.0Ag/0.5Cu  
(M705-GRN360-K2-V made by Senju Metal Industry Co.)
- Test PCB : PCB material and size  
Glass epoxy 32.85×18.3×0.8mm  
Land size, per recommended on page 5.
- Metal mask : Thickness and opening size  
Per recommended on page 5.

This temperature profile is based on the above conditions. It may vastly depending on solder paste type, manufacturer, PCB size and mounting materials. Please use only after checking the mounting conditions.

## ◆ Operation Methods of Connectors and Precautions

### Operation Methods

This connector requires delicate and careful handling due to its small design.

#### 1. Initial condition

- ① Actuator does not have to be operated before inserting FPC, as the connector is delivered with the actuator opened.

[Caution]

- Do not close the actuator before inserting FPC. Closing the actuator without FPC could make the contact gap smaller, which could increase the FPC insertion force.

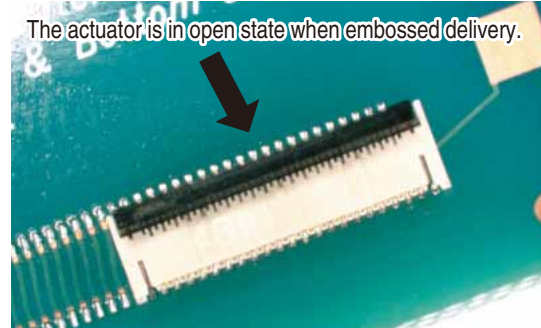

#### 2. How to insert FPC

- ① Keeping level with the PCB, make sure to insert the FPC all the way.

[Caution]

- Insert the FPC with the actuator opened.
- During FPC insertion, do not twist the FPC to up and down, right and left or an angle. It may cause deformation of the contacts and contact failure.

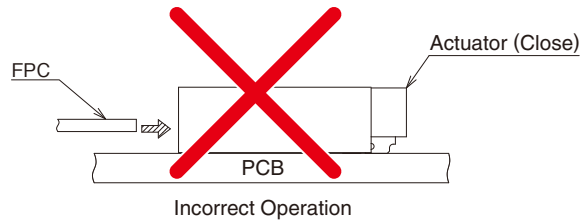
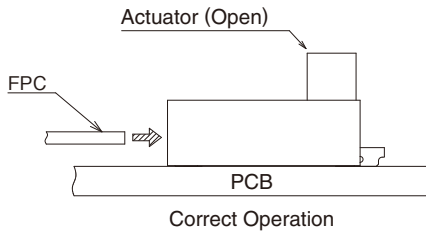

#### 3. FPC insertion check

Chucking metals guide the FPC tabs to the correct position.

Make sure that the FPC tabs are located in proper position as shown in the figure below after FPC insertion.

Incomplete FPC insertion



NG

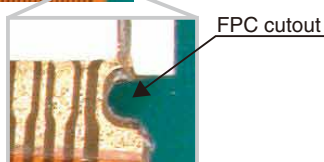

Through the FPC cutout, PCB is visible

Correct FPC insertion

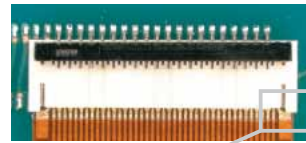

OK



The FPC cutout is hidden by the connector housing and PCB is not visible from the cutout

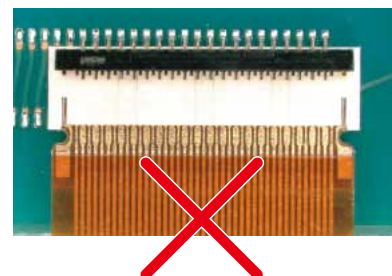
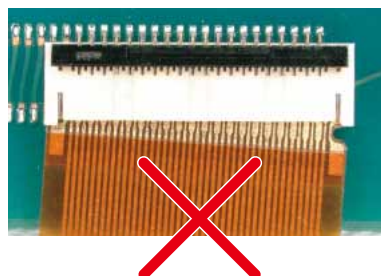
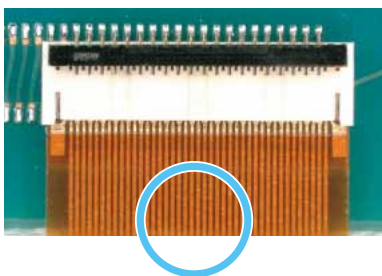

### Operation Methods

#### 4. How to lock

- ① Apply load to rotate the actuator by 90 degree after inserting the FPC.
  - Operate the actuator by hand without using sharp tool such as Tweezers.
  - To close the actuator, operate at the center of the actuator.
  - To close the actuator, do not operate the actuator at one end only.
  - Do not apply excess force to the housing during the operation.

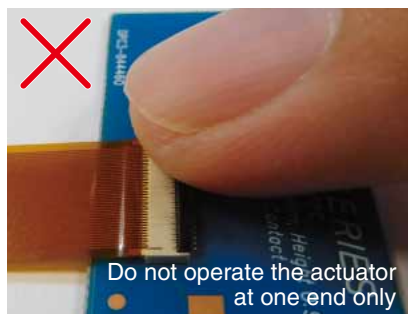
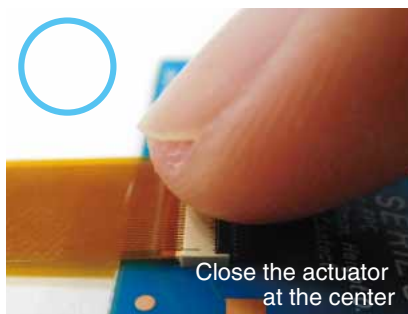
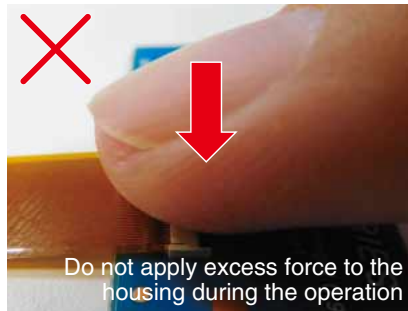
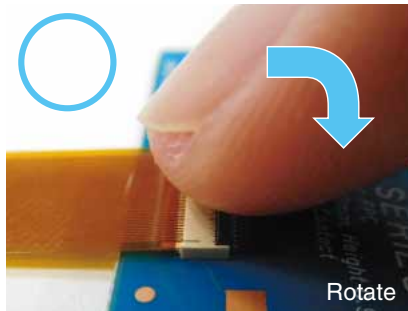

#### 5. How to remove FPC (How to unlock FPC)

- ① Slowly flip up the actuator to release the lock. After rotating the actuator to the fully opened position carefully withdraw the FPC.
- ② To open the actuator, operate at the center of the actuator. (Do not lift up only one side of the actuator. The actuator can be twisted causing damage.)
- \*The actuator is opened up to the movable limit 90 degree. Do not open the actuator beyond the specified degree or apply excess force to the actuator.

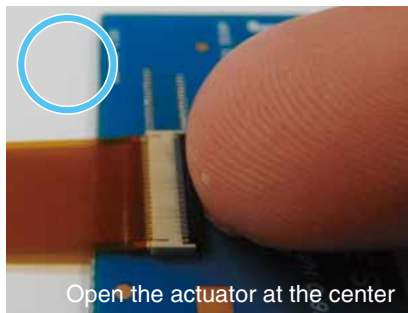
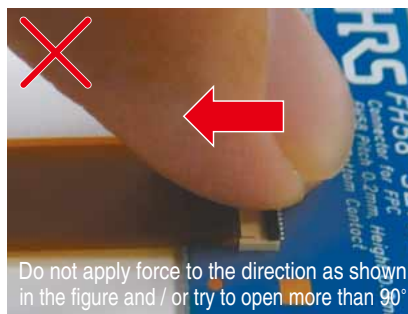
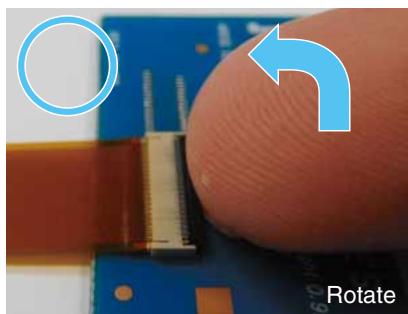

\*This connector utilizes a back flip system; the actuator is placed on the side opposite of the FPC insertion opening. Do not attempt to open the actuator from the FPC insertion side.

## Operation Methods

### 6. FPC routing after connection

- ① Depending on a FPC rounding, a load is applied to connector, and a contact failure may occur. To prevent a failure, take the following notes into a consideration during mechanism design.

[Caution]

- Make sure that FPC and stiffener do not contact chassis.
- Avoid applying forces to FPC in vertical or horizontal directions. In addition, avoid pulling up and down on the FPC.
- When fixing FPC after FPC cabling, avoid pulling FPC, and route the wire FPC with slack. In this regard, the stiffener is parallel to the PCB.
- Do not mount other components touching to the FPC underneath the FPC stiffener.

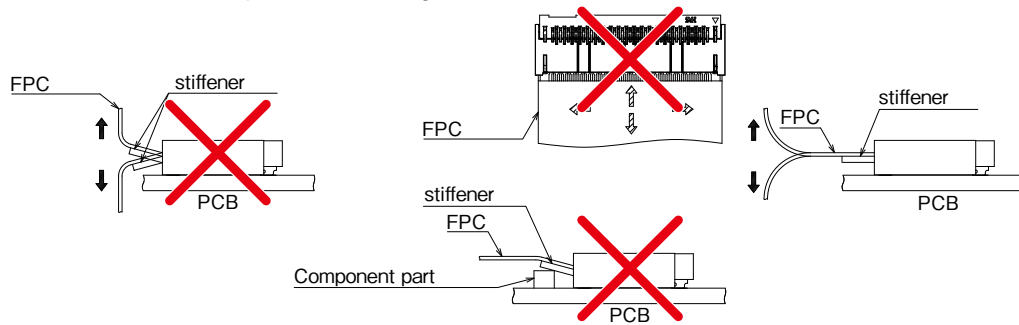

## Cautions when Mounting PCB

### ◆ Warp of PCB

Minimize warp of the PCB as much as possible.  
Lead co-planarity including reinforced metals is 0.1mm or less.  
Too much warp of the PCB may result in a soldering failure.

### ◆ Flexible board design

Please make sure to put a stiffener on the backside of the flexible board.  
We recommend a glass epoxy material with the thickness of 0.3mm MIN.

### ◆ Load to Connector

Do not add 0.5N or greater external force when unreel or pick and place the connector etc, or it may get broken.  
In addition, do not insert the FPC or operate the connector before mounting.

### ◆ Load to PCB

- Splitting a large PCB into several pieces
  - Screwing the PCB
- Avoid the handling described above so that no force is exerted on the PCB during the assembly process.  
Otherwise, the connector may become defective.

### ◆ Instructions on manual soldering

Follow the instructions shown below when soldering the connector manually during work, etc.

- ① Do not perform manual soldering with the FPC inserted into the connector.
- ② Do not heat the connector excessively. Be very careful not to let the soldering iron contact any parts other than connector leads. Otherwise, the connector may be deformed or melt.
- ③ Do not supply excessive solder (or flux).  
If excessive solder (or flux) is supplied on the terminals, solder or flux may adhere to the contacts or rotating parts of the actuator, resulting in poor contact or a rotation failure of the actuator.  
Supplying excessive solder to the chucking metals may hinder actuator rotation, resulting in breakage of the connector.

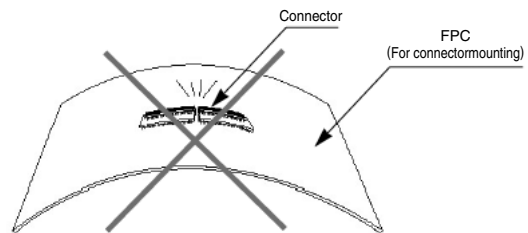

# HIROSE ELECTRIC CO.,LTD.

2-6-3,Nakagawa Chuoh,Tsuzuki-Ku,Yokohama-Shi 224-8540,JAPAN

TEL: +81-45-620-3526 Fax: +81-45-591-3726

<http://www.hirose.com>

<http://www.hirose-connectors.com>

# Mouser Electronics

Authorized Distributor

Click to View Pricing, Inventory, Delivery & Lifecycle Information:

[Hirose Electric:](#)

[FH58-35S-0.2SHW\(99\)](#)