

Positive Voltage Regulators

100 mA

MC78L00A Series, NCV78L00A

The MC78L00A Series of positive voltage regulators are inexpensive, easy-to-use devices suitable for a multitude of applications that require a regulated supply of up to 100 mA. Like their higher powered MC7800 and MC78M00 Series cousins, these regulators feature internal current limiting and thermal shutdown making them remarkably rugged. No external components are required with the MC78L00 devices in many applications.

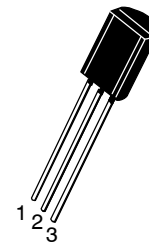
These devices offer a substantial performance advantage over the traditional zener diode-resistor combination, as output impedance and quiescent current are substantially reduced.

Features

- Wide Range of Available, Fixed Output Voltages
- Low Cost
- Internal Short Circuit Current Limiting
- Internal Thermal Overload Protection
- No External Components Required
- Complementary Negative Regulators Offered (MC79L00A Series)
- NCV Prefix for Automotive and Other Applications Requiring Unique Site and Control Change Requirements; AEC-Q100 Qualified and PPAP Capable
- These are Pb-Free Devices

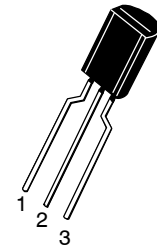


Figure 1. Representative Schematic Diagram



STRAIGHT LEAD

TO-92
P SUFFIX
CASE 29-10

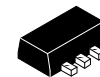


BENT LEAD

Pin: 1. Output
2. Ground
3. Input



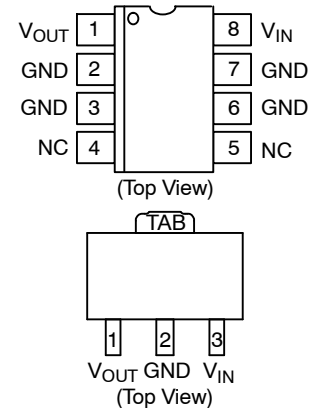
SOIC-8*
D SUFFIX
CASE 751



SOT-89
CASE 528AG

*SOIC-8 is an internally modified SO-8 package. Pins 2, 3, 6, and 7 are electrically common to the die attach flag. This internal lead frame modification decreases package thermal resistance and increases power dissipation capability when appropriately mounted on a printed circuit board. SOIC-8 conforms to all external dimensions of the standard SO-8 package.

PIN CONNECTIONS



ORDERING INFORMATION

See detailed ordering and shipping information in the package dimensions section on page 9 of this data sheet.

DEVICE MARKING INFORMATION

See general marking information in the device marking section on page 12 of this data sheet.

MC78L00A Series, NCV78L00A



Figure 2. Standard Application

A common ground is required between the input and the output voltages. The input voltage must remain typically 2.0 V above the output voltage even during the low point on the input ripple voltage.

* C_{in} is required if regulator is located an appreciable distance from power supply filter.

** C_O is not needed for stability; however, it does improve transient response.

ABSOLUTE MAXIMUM RATINGS

Rating	Symbol	Value	Unit
Input Voltage (5.0 V–9.0 V) (12 V–18 V) (24 V)	V_I	30 35 40	Vdc
Storage Temperature Range	T_{stg}	-65 to +150	°C
Maximum Junction Temperature	T_J	150	°C
Moisture Sensitivity Level	MSL	1	–
ESD Capability, Human Body Model (Note 1)	ESD_{HBM}	2000	V
ESD Capability, Machine Model (Note 1)	ESD_{MM}	200	V
ESD Capability, Charged Device Model (Note 1)	ESD_{CDM}	2000	V

Stresses exceeding those listed in the Maximum Ratings table may damage the device. If any of these limits are exceeded, device functionality should not be assumed, damage may occur and reliability may be affected.

- This device series incorporates ESD protection and is tested by the following methods:
ESD Human Body Model tested per AEC-Q100-002 (EIA/JESD22-A114)
ESD Machine Model tested per AEC-Q100-003 (EIA/JESD22-A115)
ESD Charged Device Model tested per EIA/JES D22/C101, Field Induced Charge Model.

THERMAL CHARACTERISTICS

Rating	Symbol	Value	Unit
Package Dissipation	PD	Internally Limited	W
Thermal Characteristics, TO-92 Thermal Resistance, Junction-to-Ambient	$R_{\theta JA}$	200	°C/W
Thermal Characteristics, SOIC8 Thermal Resistance, Junction-to-Ambient	$R_{\theta JA}$	Refer to Figure 8	°C/W
Thermal Characteristics, SOT-89 Thermal Resistance, Junction-to-Ambient	$R_{\theta JA}$	55	°C/W

- Thermal Resistance, Junction-to-Ambient depends on P.C.B. Copper area. See details in Figure 8.

Thermal Resistance, Junction-to-Case is not defined. SOIC 8 lead and TO-92 packages that do not have a heat sink like other packages may have. This is the reason that a θ_{JC} is never specified. A little heat transfer will occur through the package but since it is plastic, it is minimal. The majority of the heat that is transferred is through the leads where they connect to the circuit board.

MC78L00A Series, NCV78L00A

ELECTRICAL CHARACTERISTICS ($V_I = 10\text{ V}$, $I_O = 40\text{ mA}$, $C_I = 0.33\text{ }\mu\text{F}$, $C_O = 0.1\text{ }\mu\text{F}$, $-40^\circ\text{C} < T_J < +125^\circ\text{C}$ (for MC78LXXAB, NCV78L05A), $0^\circ\text{C} < T_J < +125^\circ\text{C}$ (for MC78LXXAC), unless otherwise noted.)

Characteristics	Symbol	MC78L05AC, AB, NCV78L05A			Unit
		Min	Typ	Max	
Output Voltage ($T_J = +25^\circ\text{C}$)	V_O	4.8	5.0	5.2	Vdc
Line Regulation ($T_J = +25^\circ\text{C}$, $I_O = 40\text{ mA}$) $7.0\text{ Vdc} \leq V_I \leq 20\text{ Vdc}$ $8.0\text{ Vdc} \leq V_I \leq 20\text{ Vdc}$	Reg_{line}	– –	55 45	150 100	mV
Load Regulation ($T_J = +25^\circ\text{C}$, $1.0\text{ mA} \leq I_O \leq 100\text{ mA}$) ($T_J = +25^\circ\text{C}$, $1.0\text{ mA} \leq I_O \leq 40\text{ mA}$)	Reg_{load}	– –	11 5.0	60 30	mV
Output Voltage ($7.0\text{ Vdc} \leq V_I \leq 20\text{ Vdc}$, $1.0\text{ mA} \leq I_O \leq 40\text{ mA}$) ($V_I = 10\text{ V}$, $1.0\text{ mA} \leq I_O \leq 70\text{ mA}$)	V_O	4.75 4.75	– –	5.25 5.25	Vdc
Input Bias Current ($T_J = +25^\circ\text{C}$) ($T_J = +125^\circ\text{C}$)	I_{IB}	– –	3.8 –	6.0 5.5	mA
Input Bias Current Change ($8.0\text{ Vdc} \leq V_I \leq 20\text{ Vdc}$) ($1.0\text{ mA} \leq I_O \leq 40\text{ mA}$)	ΔI_{IB}	– –	– –	1.5 0.1	mA
Output Noise Voltage ($T_A = +25^\circ\text{C}$, $10\text{ Hz} \leq f \leq 100\text{ kHz}$)	V_n	–	40	–	μV
Ripple Rejection ($I_O = 40\text{ mA}$, $f = 120\text{ Hz}$, $8.0\text{ Vdc} \leq V_I \leq 18\text{ V}$, $T_J = +25^\circ\text{C}$)	RR	41	49	–	dB
Dropout Voltage ($T_J = +25^\circ\text{C}$)	$V_I - V_O$	–	1.7	–	Vdc

NOTE: NCV78L05A: $T_{\text{low}} = -40^\circ\text{C}$, $T_{\text{high}} = +125^\circ\text{C}$. Guaranteed by design. NCV prefix is for automotive and other applications requiring site and change control.

ELECTRICAL CHARACTERISTICS ($V_I = 14\text{ V}$, $I_O = 40\text{ mA}$, $C_I = 0.33\text{ }\mu\text{F}$, $C_O = 0.1\text{ }\mu\text{F}$, $-40^\circ\text{C} < T_J < +125^\circ\text{C}$ (for MC78LXXAB), $0^\circ\text{C} < T_J < +125^\circ\text{C}$ (for MC78LXXAC), unless otherwise noted.)

Characteristics	Symbol	MC78L08AC, AB			Unit
		Min	Typ	Max	
Output Voltage ($T_J = +25^\circ\text{C}$)	V_O	7.7	8.0	8.3	Vdc
Line Regulation ($T_J = +25^\circ\text{C}$, $I_O = 40\text{ mA}$) $10.5\text{ Vdc} \leq V_I \leq 23\text{ Vdc}$ $11\text{ Vdc} \leq V_I \leq 23\text{ Vdc}$	Reg_{line}	– –	20 12	175 125	mV
Load Regulation ($T_J = +25^\circ\text{C}$, $1.0\text{ mA} \leq I_O \leq 100\text{ mA}$) ($T_J = +25^\circ\text{C}$, $1.0\text{ mA} \leq I_O \leq 40\text{ mA}$)	Reg_{load}	– –	15 8.0	80 40	mV
Output Voltage ($10.5\text{ Vdc} \leq V_I \leq 23\text{ Vdc}$, $1.0\text{ mA} \leq I_O \leq 40\text{ mA}$) ($V_I = 14\text{ V}$, $1.0\text{ mA} \leq I_O \leq 70\text{ mA}$)	V_O	7.6 7.6	– –	8.4 8.4	Vdc
Input Bias Current ($T_J = +25^\circ\text{C}$) ($T_J = +125^\circ\text{C}$)	I_{IB}	– –	3.0 –	6.0 5.5	mA
Input Bias Current Change ($11\text{ Vdc} \leq V_I \leq 23\text{ Vdc}$) ($1.0\text{ mA} \leq I_O \leq 40\text{ mA}$)	ΔI_{IB}	– –	– –	1.5 0.1	mA
Output Noise Voltage ($T_A = +25^\circ\text{C}$, $10\text{ Hz} \leq f \leq 100\text{ kHz}$)	V_n	–	60	–	μV
Ripple Rejection ($I_O = 40\text{ mA}$, $f = 120\text{ Hz}$, $12\text{ V} \leq V_I \leq 23\text{ V}$, $T_J = +25^\circ\text{C}$)	RR	37	57	–	dB
Dropout Voltage ($T_J = +25^\circ\text{C}$)	$V_I - V_O$	–	1.7	–	Vdc

MC78L00A Series, NCV78L00A

ELECTRICAL CHARACTERISTICS ($V_I = 15\text{ V}$, $I_O = 40\text{ mA}$, $C_I = 0.33\text{ }\mu\text{F}$, $C_O = 0.1\text{ }\mu\text{F}$, $-40^\circ\text{C} < T_J < +125^\circ\text{C}$ (for MC78LXXAB), $0^\circ\text{C} < T_J < +125^\circ\text{C}$ (for MC78LXXAC), unless otherwise noted.)

Characteristics	Symbol	MC78L09AC, AB			Unit
		Min	Typ	Max	
Output Voltage ($T_J = +25^\circ\text{C}$)	V_O	8.6	9.0	9.4	Vdc
Line Regulation ($T_J = +25^\circ\text{C}$, $I_O = 40\text{ mA}$) $11.5\text{ Vdc} \leq V_I \leq 24\text{ Vdc}$ $12\text{ Vdc} \leq V_I \leq 24\text{ Vdc}$	Reg_{line}	– –	20 12	175 125	mV
Load Regulation ($T_J = +25^\circ\text{C}$, $1.0\text{ mA} \leq I_O \leq 100\text{ mA}$) ($T_J = +25^\circ\text{C}$, $1.0\text{ mA} \leq I_O \leq 40\text{ mA}$)	Reg_{load}	– –	15 8.0	90 40	mV
Output Voltage ($11.5\text{ Vdc} \leq V_I \leq 24\text{ Vdc}$, $1.0\text{ mA} \leq I_O \leq 40\text{ mA}$) ($V_I = 15\text{ V}$, $1.0\text{ mA} \leq I_O \leq 70\text{ mA}$)	V_O	8.5 8.5	– –	9.5 9.5	Vdc
Input Bias Current ($T_J = +25^\circ\text{C}$) ($T_J = +125^\circ\text{C}$)	I_{IB}	– –	3.0 –	6.0 5.5	mA
Input Bias Current Change ($11\text{ Vdc} \leq V_I \leq 23\text{ Vdc}$) ($1.0\text{ mA} \leq I_O \leq 40\text{ mA}$)	ΔI_{IB}	– –	– –	1.5 0.1	mA
Output Noise Voltage ($T_A = +25^\circ\text{C}$, $10\text{ Hz} \leq f \leq 100\text{ kHz}$)	V_n	–	60	–	μV
Ripple Rejection ($I_O = 40\text{ mA}$, $f = 120\text{ Hz}$, $13\text{ V} \leq V_I \leq 24\text{ V}$, $T_J = +25^\circ\text{C}$)	RR	37	57	–	dB
Dropout Voltage ($T_J = +25^\circ\text{C}$)	$V_I - V_O$	–	1.7	–	Vdc

ELECTRICAL CHARACTERISTICS ($V_I = 19\text{ V}$, $I_O = 40\text{ mA}$, $C_I = 0.33\text{ }\mu\text{F}$, $C_O = 0.1\text{ }\mu\text{F}$, $-40^\circ\text{C} < T_J < +125^\circ\text{C}$ (for MC78LXXAB), $0^\circ\text{C} < T_J < +125^\circ\text{C}$ (for MC78LXXAC), unless otherwise noted.)

Characteristics	Symbol	MC78L12AC, AB			Unit
		Min	Typ	Max	
Output Voltage ($T_J = +25^\circ\text{C}$)	V_O	11.5	12	12.5	Vdc
Line Regulation ($T_J = +25^\circ\text{C}$, $I_O = 40\text{ mA}$) $14.5\text{ Vdc} \leq V_I \leq 27\text{ Vdc}$ $16\text{ Vdc} \leq V_I \leq 27\text{ Vdc}$	Reg_{line}	– –	120 100	250 200	mV
Load Regulation ($T_J = +25^\circ\text{C}$, $1.0\text{ mA} \leq I_O \leq 100\text{ mA}$) ($T_J = +25^\circ\text{C}$, $1.0\text{ mA} \leq I_O \leq 40\text{ mA}$)	Reg_{load}	– –	20 10	100 50	mV
Output Voltage ($14.5\text{ Vdc} \leq V_I \leq 27\text{ Vdc}$, $1.0\text{ mA} \leq I_O \leq 40\text{ mA}$) ($V_I = 19\text{ V}$, $1.0\text{ mA} \leq I_O \leq 70\text{ mA}$)	V_O	11.4 11.4	– –	12.6 12.6	Vdc
Input Bias Current ($T_J = +25^\circ\text{C}$) ($T_J = +125^\circ\text{C}$)	I_{IB}	– –	4.2 –	6.5 6.0	mA
Input Bias Current Change ($16\text{ Vdc} \leq V_I \leq 27\text{ Vdc}$) ($1.0\text{ mA} \leq I_O \leq 40\text{ mA}$)	ΔI_{IB}	– –	– –	1.5 0.1	mA
Output Noise Voltage ($T_A = +25^\circ\text{C}$, $10\text{ Hz} \leq f \leq 100\text{ kHz}$)	V_n	–	80	–	μV
Ripple Rejection ($I_O = 40\text{ mA}$, $f = 120\text{ Hz}$, $15\text{ V} \leq V_I \leq 25\text{ V}$, $T_J = +25^\circ\text{C}$)	RR	37	42	–	dB
Dropout Voltage ($T_J = +25^\circ\text{C}$)	$V_I - V_O$	–	1.7	–	Vdc

MC78L00A Series, NCV78L00A

ELECTRICAL CHARACTERISTICS ($V_I = 23\text{ V}$, $I_O = 40\text{ mA}$, $C_I = 0.33\text{ }\mu\text{F}$, $C_O = 0.1\text{ }\mu\text{F}$, $-40^\circ\text{C} < T_J < +125^\circ\text{C}$ (for MC78LXXAB), $0^\circ\text{C} < T_J < +125^\circ\text{C}$ (for MC78LXXAC), unless otherwise noted.)

Characteristics	Symbol	MC78L15AC, AB / NCV78L15A			Unit
		Min	Typ	Max	
Output Voltage ($T_J = +25^\circ\text{C}$)	V_O	14.4	15	15.6	Vdc
Line Regulation ($T_J = +25^\circ\text{C}$, $I_O = 40\text{ mA}$) $17.5\text{ Vdc} \leq V_I \leq 30\text{ Vdc}$ $20\text{ Vdc} \leq V_I \leq 30\text{ Vdc}$	Reg_{line}	–	130 110	300 250	mV
Load Regulation ($T_J = +25^\circ\text{C}$, $1.0\text{ mA} \leq I_O \leq 100\text{ mA}$) ($T_J = +25^\circ\text{C}$, $1.0\text{ mA} \leq I_O \leq 40\text{ mA}$)	Reg_{load}	–	25 12	150 75	mV
Output Voltage ($17.5\text{ Vdc} \leq V_I \leq 30\text{ Vdc}$, $1.0\text{ mA} \leq I_O \leq 40\text{ mA}$) ($V_I = 23\text{ V}$, $1.0\text{ mA} \leq I_O \leq 70\text{ mA}$)	V_O	14.25 14.25	–	15.75 15.75	Vdc
Input Bias Current ($T_J = +25^\circ\text{C}$) ($T_J = +125^\circ\text{C}$)	I_{IB}	–	4.4 –	6.5 6.0	mA
Input Bias Current Change ($20\text{ Vdc} \leq V_I \leq 30\text{ Vdc}$) ($1.0\text{ mA} \leq I_O \leq 40\text{ mA}$)	ΔI_{IB}	–	–	1.5 0.1	mA
Output Noise Voltage ($T_A = +25^\circ\text{C}$, $10\text{ Hz} \leq f \leq 100\text{ kHz}$)	V_n	–	90	–	μV
Ripple Rejection ($I_O = 40\text{ mA}$, $f = 120\text{ Hz}$, $18.5\text{ V} \leq V_I \leq 28.5\text{ V}$, $T_J = +25^\circ\text{C}$)	RR	34	39	–	dB
Dropout Voltage ($T_J = +25^\circ\text{C}$)	$V_I - V_O$	–	1.7	–	Vdc

ELECTRICAL CHARACTERISTICS ($V_I = 27\text{ V}$, $I_O = 40\text{ mA}$, $C_I = 0.33\text{ }\mu\text{F}$, $C_O = 0.1\text{ }\mu\text{F}$, $0^\circ\text{C} < T_J < +125^\circ\text{C}$, unless otherwise noted.)

Characteristics	Symbol	MC78L18AC			Unit
		Min	Typ	Max	
Output Voltage ($T_J = +25^\circ\text{C}$)	V_O	17.3	18	18.7	Vdc
Line Regulation ($T_J = +25^\circ\text{C}$, $I_O = 40\text{ mA}$) $21.4\text{ Vdc} \leq V_I \leq 33\text{ Vdc}$ $20.7\text{ Vdc} \leq V_I \leq 33\text{ Vdc}$ $22\text{ Vdc} \leq V_I \leq 33\text{ Vdc}$ $21\text{ Vdc} \leq V_I \leq 33\text{ Vdc}$	Reg_{line}	–	45 35	325 275	mV
Load Regulation ($T_J = +25^\circ\text{C}$, $1.0\text{ mA} \leq I_O \leq 100\text{ mA}$) ($T_J = +25^\circ\text{C}$, $1.0\text{ mA} \leq I_O \leq 40\text{ mA}$)	Reg_{load}	–	30 15	170 85	mV
Output Voltage ($21.4\text{ Vdc} \leq V_I \leq 33\text{ Vdc}$, $1.0\text{ mA} \leq I_O \leq 40\text{ mA}$) ($20.7\text{ Vdc} \leq V_I \leq 33\text{ Vdc}$, $1.0\text{ mA} \leq I_O \leq 40\text{ mA}$) ($V_I = 27\text{ V}$, $1.0\text{ mA} \leq I_O \leq 70\text{ mA}$) ($V_I = 27\text{ V}$, $1.0\text{ mA} \leq I_O \leq 70\text{ mA}$)	V_O	17.1 17.1	–	18.9 18.9	Vdc
Input Bias Current ($T_J = +25^\circ\text{C}$) ($T_J = +125^\circ\text{C}$)	I_{IB}	–	3.1 –	6.5 6.0	mA
Input Bias Current Change ($22\text{ Vdc} \leq V_I \leq 33\text{ Vdc}$) ($21\text{ Vdc} \leq V_I \leq 33\text{ Vdc}$) ($1.0\text{ mA} \leq I_O \leq 40\text{ mA}$)	ΔI_{IB}	–	–	1.5 0.1	mA
Output Noise Voltage ($T_A = +25^\circ\text{C}$, $10\text{ Hz} \leq f \leq 100\text{ kHz}$)	V_n	–	150	–	μV
Ripple Rejection ($I_O = 40\text{ mA}$, $f = 120\text{ Hz}$, $23\text{ V} \leq V_I \leq 33\text{ V}$, $T_J = +25^\circ\text{C}$)	RR	33	48	–	dB
Dropout Voltage ($T_J = +25^\circ\text{C}$)	$V_I - V_O$	–	1.7	–	Vdc

MC78L00A Series, NCV78L00A

ELECTRICAL CHARACTERISTICS ($V_I = 33\text{ V}$, $I_O = 40\text{ mA}$, $C_I = 0.33\text{ }\mu\text{F}$, $C_O = 0.1\text{ }\mu\text{F}$, $0^\circ\text{C} < T_J < +125^\circ\text{C}$, unless otherwise noted.)

Characteristics	Symbol	MC78L24AC			Unit
		Min	Typ	Max	
Output Voltage ($T_J = +25^\circ\text{C}$)	V_O	23	24	25	Vdc
Line Regulation ($T_J = +25^\circ\text{C}$, $I_O = 40\text{ mA}$) $27.5\text{ Vdc} \leq V_I \leq 38\text{ Vdc}$ $28\text{ Vdc} \leq V_I \leq 80\text{ Vdc}$ $27\text{ Vdc} \leq V_I \leq 38\text{ Vdc}$	Reg_{line}	- - -	- 50 60	- 300 350	mV
Load Regulation ($T_J = +25^\circ\text{C}$, $1.0\text{ mA} \leq I_O \leq 100\text{ mA}$) ($T_J = +25^\circ\text{C}$, $1.0\text{ mA} \leq I_O \leq 40\text{ mA}$)	Reg_{load}	- -	40 20	200 100	mV
Output Voltage ($28\text{ Vdc} \leq V_I \leq 38\text{ Vdc}$, $1.0\text{ mA} \leq I_O \leq 40\text{ mA}$) ($27\text{ Vdc} \leq V_I \leq 38\text{ Vdc}$, $1.0\text{ mA} \leq I_O \leq 40\text{ mA}$) ($28\text{ Vdc} \leq V_I \leq 33\text{ Vdc}$, $1.0\text{ mA} \leq I_O \leq 70\text{ mA}$) ($27\text{ Vdc} \leq V_I \leq 33\text{ Vdc}$, $1.0\text{ mA} \leq I_O \leq 70\text{ mA}$)	V_O	22.8 22.8	- -	25.2 25.2	Vdc
Input Bias Current ($T_J = +25^\circ\text{C}$) ($T_J = +125^\circ\text{C}$)	I_{IB}	- -	3.1 -	6.5 6.0	mA
Input Bias Current Change ($28\text{ Vdc} \leq V_I \leq 38\text{ Vdc}$) ($1.0\text{ mA} \leq I_O \leq 40\text{ mA}$)	ΔI_{IB}	- -	- -	1.5 0.1	mA
Output Noise Voltage ($T_A = +25^\circ\text{C}$, $10\text{ Hz} \leq f \leq 100\text{ kHz}$)	V_n	-	200	-	μV
Ripple Rejection ($I_O = 40\text{ mA}$, $f = 120\text{ Hz}$, $29\text{ V} \leq V_I \leq 35\text{ V}$, $T_J = +25^\circ\text{C}$)	RR	31	45	-	dB
Dropout Voltage ($T_J = +25^\circ\text{C}$)	$V_I - V_O$	-	1.7	-	Vdc

Product parametric performance is indicated in the Electrical Characteristics for the listed test conditions, unless otherwise noted. Product performance may not be indicated by the Electrical Characteristics if operated under different conditions.

MC78L00A Series, NCV78L00A

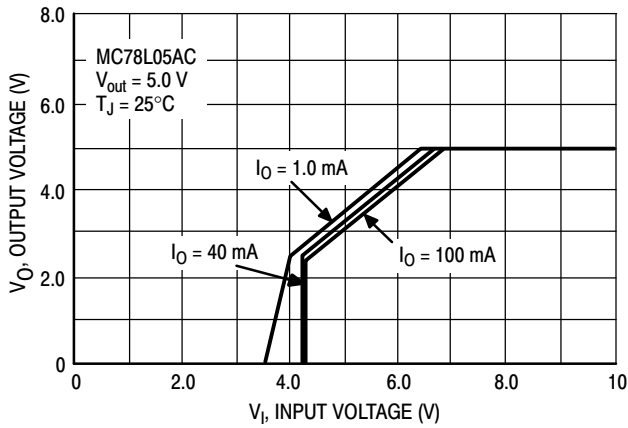


Figure 3. Dropout Characteristics

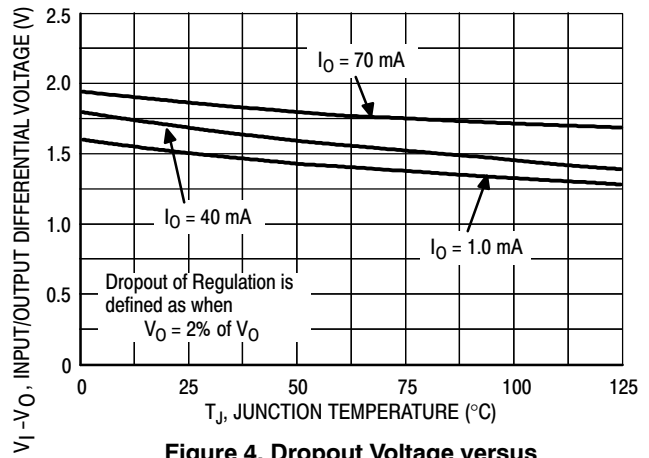


Figure 4. Dropout Voltage versus Junction Temperature



Figure 5. Input Bias Current versus Ambient Temperature

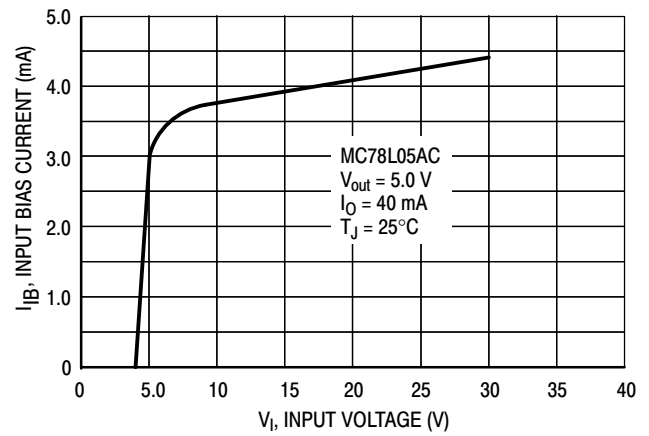


Figure 6. Input Bias Current versus Input Voltage



Figure 7. Maximum Average Power Dissipation versus Ambient Temperature – TO-92 Type Package

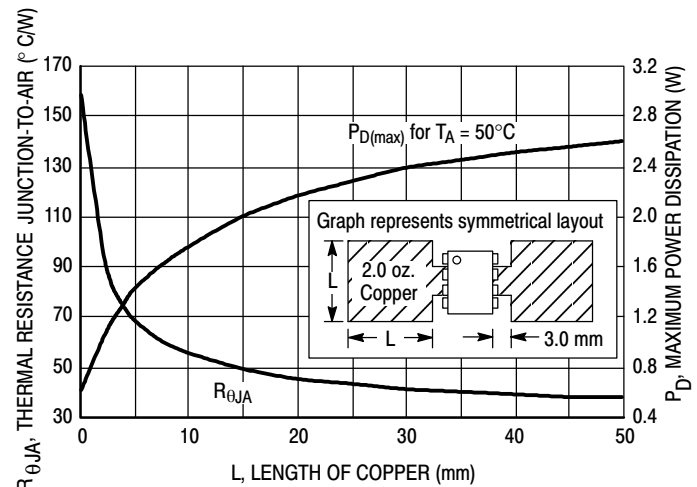


Figure 8. SOIC-8 Thermal Resistance and Maximum Power Dissipation versus P.C.B. Copper Length

MC78L00A Series, NCV78L00A

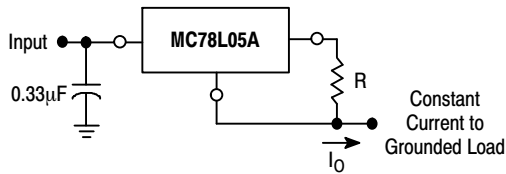
APPLICATIONS INFORMATION

Design Considerations

The MC78L00A Series of fixed voltage regulators are designed with Thermal Overload Protection that shuts down the circuit when subjected to an excessive power overload condition. Internal Short Circuit Protection limits the maximum current the circuit will pass.

In many low current applications, compensation capacitors are not required. However, it is recommended that the regulator input be bypassed with a capacitor if the regulator is connected to the power supply filter with long wire lengths, or if the output load capacitance is large. The

input bypass capacitor should be selected to provide good high-frequency characteristics to insure stable operation under all load conditions. A 0.33 μF or larger tantalum, mylar, or other capacitor having low internal impedance at high frequencies should be chosen. The bypass capacitor should be mounted with the shortest possible leads directly across the regulators input terminals. Good construction techniques should be used to minimize ground loops and lead resistance drops since the regulator has no external sense lead. Bypassing the output is also recommended.



The MC78L00 regulators can also be used as a current source when connected as above. In order to minimize dissipation the MC78L05C is chosen in this application. Resistor R determines the current as follows:

$$I_O = \frac{5.0 \text{ V}}{R} + I_B$$

$$I_B = 3.8 \text{ mA over line and load changes}$$

For example, a 100 mA current source would require R to be a 50 Ω, 1/2 W resistor and the output voltage compliance would be the input voltage less 7 V.

Figure 9. Current Regulator



Figure 10. ±15 V Tracking Voltage Regulator

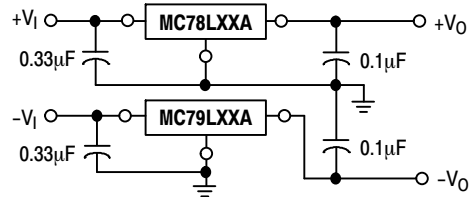


Figure 11. Positive and Negative Regulator

MC78L00A Series, NCV78L00A

ORDERING INFORMATION

Device	Output Voltage	Operating Temperature Range	Package	Shipping [†]
MC78L05ABDG	5.0 V	T _J = -40° to +125°C	SOIC-8 (Pb-Free)	98 Units / Rail
NCV78L05ABDG*	5.0 V	T _J = -40° to +125°C	SOIC-8 (Pb-Free)	98 Units / Rail
MC78L05ABDR2G	5.0 V	T _J = -40° to +125°C	SOIC-8 (Pb-Free)	2500 / Tape & Reel
NCV78L05ABDR2G*	5.0 V	T _J = -40° to +125°C	SOIC-8 (Pb-Free)	2500 / Tape & Reel
MC78L05ABPG	5.0 V	T _J = -40° to +125°C	TO-92 (Pb-Free)	2000 Units / Bag
NCV78L05ABPG*	5.0 V	T _J = -40° to +125°C	TO-92 (Pb-Free)	2000 Units / Bag
MC78L05ABPRAG	5.0 V	T _J = -40° to +125°C	TO-92 (Pb-Free)	2000 / Tape & Reel
NCV78L05ABPRAG*	5.0 V	T _J = -40° to +125°C	TO-92 (Pb-Free)	2000 / Tape & Reel
MC78L05ABPREG	5.0 V	T _J = -40° to +125°C	TO-92 (Pb-Free)	2000 / Tape & Reel
NCV78L05ABPREG*	5.0 V	T _J = -40° to +125°C	TO-92 (Pb-Free)	2000 / Tape & Reel
MC78L05ABPRMG	5.0 V	T _J = -40° to +125°C	TO-92 (Pb-Free)	2000 / Ammo Pack
NCV78L05ABPRMG*	5.0 V	T _J = -40° to +125°C	TO-92 (Pb-Free)	2000 / Ammo Pack
NCV78L05ABPRPG*	5.0 V	T _J = -40° to +125°C	TO-92 (Pb-Free)	2000 / Ammo Pack
MC78L05ACDG	5.0 V	T _J = 0° to +125°C	SOIC-8 (Pb-Free)	98 Units / Rail
MC78L05ACDR2G	5.0 V	T _J = 0° to +125°C	SOIC-8 (Pb-Free)	2500 / Tape & Reel
MC78L05ACPG	5.0 V	T _J = 0° to +125°C	TO-92 (Pb-Free)	2000 Units / Bag
MC78L05ACPRAG	5.0 V	T _J = 0° to +125°C	TO-92 (Pb-Free)	2000 / Tape & Reel
MC78L05ACPREG	5.0 V	T _J = 0° to +125°C	TO-92 (Pb-Free)	2000 / Tape & Reel
MC78L05ACPRMG	5.0 V	T _J = 0° to +125°C	TO-92 (Pb-Free)	2000 / Ammo Pack
MC78L05ACPRPG	5.0 V	T _J = 0° to +125°C	TO-92 (Pb-Free)	2000 / Ammo Pack
MC78L05ACHT1G	5.0 V	T _J = 0° to +125°C	SOT-89 (Pb-Free)	2500 / Tape & Reel
MC78L08ABDG	8.0 V	T _J = -40° to +125°C	SOIC-8 (Pb-Free)	98 Units / Rail

*NCV78L05A, NCV78L12A, NCV78L15A: T_{low} = -40°C, T_{high} = +125°C. Guaranteed by design. NCV Prefix for Automotive and Other Applications Requiring Unique Site and Control Change Requirements; AEC-Q100 Qualified and PPAP Capable.

†For information on tape and reel specifications, including part orientation and tape sizes, please refer to our Tape and Reel Packaging Specifications Brochure, BRD8011/D.

MC78L00A Series, NCV78L00A

ORDERING INFORMATION (continued)

Device	Output Voltage	Operating Temperature Range	Package	Shipping [†]
MC78L08ABDR2G	8.0 V	T _J = -40° to +125°C	SOIC-8 (Pb-Free)	2500 / Tape & Reel
NCV78L08ABDR2G*	8.0 V	T _J = -40° to +125°C	SOIC-8 (Pb-Free)	2500 / Tape & Reel
MC78L08ABPG	8.0 V	T _J = -40° to +125°C	TO-92 (Pb-Free)	2000 Units / Bag
MC78L08ABPRAG	8.0 V	T _J = -40° to +125°C	TO-92 (Pb-Free)	2000 / Tape & Reel
MC78L08ABPRPG	8.0 V	T _J = -40° to +125°C	TO-92 (Pb-Free)	2000 / Ammo Pack
MC78L08ACDG	8.0 V	T _J = 0° to +125°C	SOIC-8 (Pb-Free)	98 Units / Rail
MC78L08ACDR2G	8.0 V	T _J = 0° to +125°C	SOIC-8 (Pb-Free)	2500 / Tape & Reel
MC78L08ACPG	8.0 V	T _J = 0° to +125°C	TO-92 (Pb-Free)	2000 Units / Bag
MC78L08ACPRAG	8.0 V	T _J = 0° to +125°C	TO-92 (Pb-Free)	2000 / Tape & Reel
MC78L08ACPREG	8.0 V	T _J = 0° to +125°C	TO-92 (Pb-Free)	2000 / Tape & Reel
MC78L08ACPRPG	8.0 V	T _J = 0° to +125°C	TO-92 (Pb-Free)	2000 / Ammo Pack
MC78L09ABDG	9.0 V	T _J = -40° to +125°C	SOIC-8 (Pb-Free)	98 Units / Rail
MC78L09ABDR2G	9.0 V	T _J = -40° to +125°C	SOIC-8 (Pb-Free)	2500 / Tape & Reel
MC78L09ABPRAG	9.0 V	T _J = -40° to +125°C	TO-92 (Pb-Free)	2000 / Tape & Reel
MC78L09ABPRPG	9.0 V	T _J = -40° to +125°C	TO-92 (Pb-Free)	2000 / Ammo Pack
MC78L09ACDG	9.0 V	T _J = 0° to +125°C	SOIC-8 (Pb-Free)	98 Units / Rail
MC78L09ACDR2G	9.0 V	T _J = 0° to +125°C	SOIC-8 (Pb-Free)	2500 / Tape & Reel
MC78L09ACPG	9.0 V	T _J = 0° to +125°C	TO-92 (Pb-Free)	2000 Units / Bag
MC78L12ABDG	12 V	T _J = -40° to +125°C	SOIC-8 (Pb-Free)	98 Units / Rail
MC78L12ABDR2G	12 V	T _J = -40° to +125°C	SOIC-8 (Pb-Free)	2500 / Tape & Reel
NCV78L12ABDG*	12 V	T _J = -40° to +125°C	SOIC-8 (Pb-Free)	98 Units / Rail
NCV78L12ABDR2G*	12 V	T _J = -40° to +125°C	SOIC-8 (Pb-Free)	2500 / Tape & Reel
MC78L12ABPG	12 V	T _J = -40° to +125°C	TO-92 (Pb-Free)	2000 Units / Bag

*NCV78L05A, NCV78L12A, NCV78L15A: T_{low} = -40°C, T_{high} = +125°C. Guaranteed by design. NCV Prefix for Automotive and Other Applications Requiring Unique Site and Control Change Requirements; AEC-Q100 Qualified and PPAP Capable.

†For information on tape and reel specifications, including part orientation and tape sizes, please refer to our Tape and Reel Packaging Specifications Brochure, BRD8011/D.

MC78L00A Series, NCV78L00A

ORDERING INFORMATION (continued)

Device	Output Voltage	Operating Temperature Range	Package	Shipping [†]
MC78L12ABPRPG	12 V	T _J = -40° to +125°C	TO-92 (Pb-Free)	2000 / Ammo Pack
NCV78L12ABPG*	12 V	T _J = -40° to +125°C	TO-92 (Pb-Free)	2000 Units / Bag
MC78L12ACDG	12 V	T _J = 0° to +125°C	SOIC-8 (Pb-Free)	98 Units / Rail
MC78L12ACDR2G	12 V	T _J = 0° to +125°C	SOIC-8 (Pb-Free)	2500 / Tape & Reel
MC78L12ACPG	12 V	T _J = 0° to +125°C	TO-92 (Pb-Free)	2000 Units / Bag
MC78L12ACPRAG	12 V	T _J = 0° to +125°C	TO-92 (Pb-Free)	2000 / Tape & Reel
MC78L12ACPREG	12 V	T _J = 0° to +125°C	TO-92 (Pb-Free)	2000 / Tape & Reel
MC78L12ACPRMG	12 V	T _J = 0° to +125°C	TO-92 (Pb-Free)	2000 / Ammo Pack
MC78L12ACPRPG	12 V	T _J = 0° to +125°C	TO-92 (Pb-Free)	2000 / Ammo Pack
MC78L15ABDG	15 V	T _J = -40° to +125°C	SOIC-8 (Pb-Free)	98 Units / Rail
MC78L15ABDR2G	15 V	T _J = -40° to +125°C	SOIC-8 (Pb-Free)	2500 / Tape & Reel
NCV78L15ABDR2G*	15 V	T _J = -40° to +125°C	SOIC-8 (Pb-Free)	2500 / Tape & Reel
MC78L15ABPG	15 V	T _J = -40° to +125°C	TO-92 (Pb-Free)	2000 Units / Bag
MC78L15ABPRAG	15 V	T _J = -40° to +125°C	TO-92 (Pb-Free)	2000 / Tape & Reel
MC78L15ABPRPG	15 V	T _J = -40° to +125°C	TO-92 (Pb-Free)	2000 / Ammo Pack
MC78L15ACDG	15 V	T _J = 0° to +125°C	SOIC-8 (Pb-Free)	98 Units / Rail
MC78L15ACDR2G	15 V	T _J = 0° to +125°C	SOIC-8 (Pb-Free)	2500 / Tape & Reel
MC78L15ACPG	15 V	T _J = 0° to +125°C	TO-92 (Pb-Free)	2000 Units / Bag
MC78L15ACPRAG	15 V	T _J = 0° to +125°C	TO-92 (Pb-Free)	2000 / Tape & Reel
MC78L15ACPRPG	15 V	T _J = 0° to +125°C	TO-92 (Pb-Free)	2000 / Ammo Pack
MC78L18ABPG	18 V	T _J = -40° to +125°C	TO-92 (Pb-Free)	2000 Units / Bag
MC78L18ACPG	18 V	T _J = 0° to +125°C	TO-92 (Pb-Free)	2000 Units / Bag
MC78L18ACPRAG	18 V	T _J = 0° to +125°C	TO-92 (Pb-Free)	2000 / Tape & Reel

*NCV78L05A, NCV78L12A, NCV78L15A: T_{low} = -40°C, T_{high} = +125°C. Guaranteed by design. NCV Prefix for Automotive and Other Applications Requiring Unique Site and Control Change Requirements; AEC-Q100 Qualified and PPAP Capable.

†For information on tape and reel specifications, including part orientation and tape sizes, please refer to our Tape and Reel Packaging Specifications Brochure, BRD8011/D.

MC78L00A Series, NCV78L00A

ORDERING INFORMATION (continued)

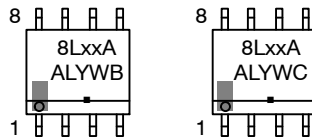
Device	Output Voltage	Operating Temperature Range	Package	Shipping [†]
MC78L18ACPRMG	18 V	T _J = 0° to +125°C	TO-92 (Pb-Free)	2000 / Ammo Pack
MC78L18ACPRPG	18 V	T _J = 0° to +125°C	TO-92 (Pb-Free)	2000 / Ammo Pack
MC78L24ABPG	24 V	T _J = -40° to +125°C	TO-92 (Pb-Free)	2000 Units / Bag
NCV78L24ABPRPG*	24 V	T _J = -40° to +125°C	TO-92 (Pb-Free)	2000 Units / Bag
MC78L24ACPG	24 V	T _J = 0° to +125°C	TO-92 (Pb-Free)	2000 Units / Bag
MC78L24ACPRAG	24 V	T _J = 0° to +125°C	TO-92 (Pb-Free)	2000 / Tape & Reel
MC78L24ACPRPG	24 V	T _J = 0° to +125°C	TO-92 (Pb-Free)	2000 / Ammo Pack

*NCV78L05A, NCV78L12A, NCV78L15A: T_{low} = -40°C, T_{high} = +125°C. Guaranteed by design. NCV Prefix for Automotive and Other Applications Requiring Unique Site and Control Change Requirements; AEC-Q100 Qualified and PPAP Capable.

†For information on tape and reel specifications, including part orientation and tape sizes, please refer to our Tape and Reel Packaging Specifications Brochure, BRD8011/D.

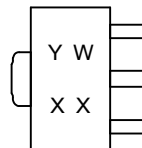
MARKING DIAGRAMS

SOIC-8 D SUFFIX CASE 751



xx = 05, 08, 09, 12, or 15
 A = Assembly Location
 L = Wafer Lot
 Y = Year
 W = Work Week
 B, C = Temperature Range
 ■ = Pb-Free Package

SOT-89 CASE 528AG



Y = Year
 W = Work Week
 XX = Specific Device Code

TO-92 P SUFFIX CASE 029



zz = 05, 08, 09, 12, 15, 18 or 24
 A = Assembly Location
 L = Wafer Lot
 Y = Year
 W = Work Week

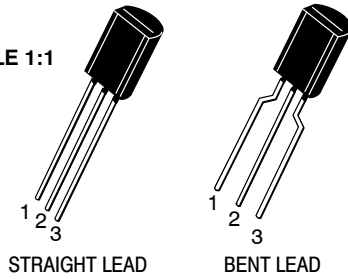
MECHANICAL CASE OUTLINE

PACKAGE DIMENSIONS

ON Semiconductor®



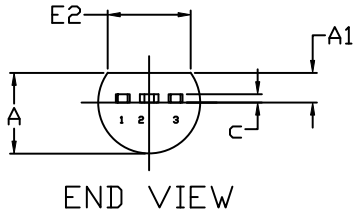
SCALE 1:1



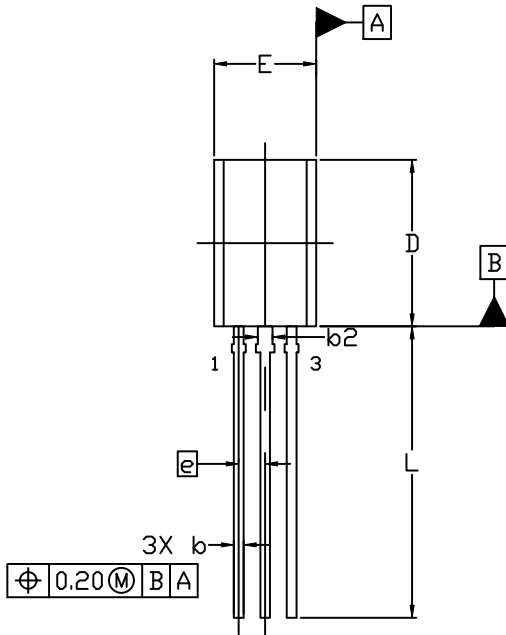
TO-92 (TO-226) 1 WATT
CASE 29-10
ISSUE D

DATE 05 MAR 2021

STRAIGHT LEAD



END VIEW



TOP VIEW

NOTES:

1. DIMENSIONING AND TOLERANCING PER ASME Y14.5M, 2009.
2. CONTROLLING DIMENSION: MILLIMETERS
3. DIMENSIONS D AND E DO NOT INCLUDE MOLD FLASH OR GATE PROTRUSIONS.
4. DIMENSION b AND b2 DOES NOT INCLUDE DAMBAR PROTRUSION. LEAD WIDTH INCLUDING PROTRUSION SHALL NOT EXCEED 0.20. DIMENSION b2 LOCATED ABOVE THE DAMBAR PORTION OF MIDDLE LEAD.

DIM	MILLIMETERS		
	MIN.	NOM.	MAX.
A	3.75	3.90	4.05
A1	1.28	1.43	1.58
b	0.38	0.465	0.55
b2	0.62	0.70	0.78
c	0.35	0.40	0.45
D	7.85	8.00	8.15
E	4.75	4.90	5.05
E2	3.90	---	---
e	1.27 BSC		
L	13.80	14.00	14.20

STYLES AND MARKING ON PAGE 3

DOCUMENT NUMBER:	98AON52857E	Electronic versions are uncontrolled except when accessed directly from the Document Repository. Printed versions are uncontrolled except when stamped "CONTROLLED COPY" in red.
DESCRIPTION:	TO-92 (TO-226) 1 WATT	PAGE 1 OF 3

ON Semiconductor and are trademarks of Semiconductor Components Industries, LLC dba ON Semiconductor or its subsidiaries in the United States and/or other countries. ON Semiconductor reserves the right to make changes without further notice to any products herein. ON Semiconductor makes no warranty, representation or guarantee regarding the suitability of its products for any particular purpose, nor does ON Semiconductor assume any liability arising out of the application or use of any product or circuit, and specifically disclaims any and all liability, including without limitation special, consequential or incidental damages. ON Semiconductor does not convey any license under its patent rights nor the rights of others.

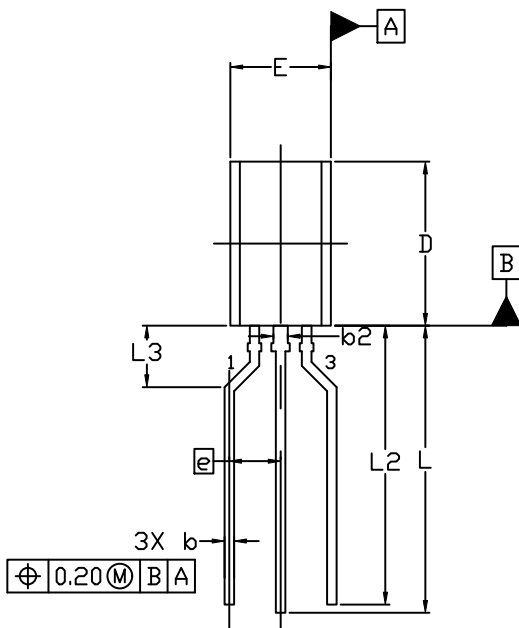
TO-92 (TO-226) 1 WATT
CASE 29-10
ISSUE D

DATE 05 MAR 2021

FORMED LEAD



END VIEW



TOP VIEW

NOTES:

1. DIMENSIONING AND TOLERANCING PER ASME Y14.5M, 2009.
2. CONTROLLING DIMENSION: MILLIMETERS
3. DIMENSIONS D AND E DO NOT INCLUDE MOLD FLASH OR GATE PROTRUSIONS.
4. DIMENSION b AND b2 DOES NOT INCLUDE DAMBAR PROTRUSION. LEAD WIDTH INCLUDING PROTRUSION SHALL NOT EXCEED 0.20. DIMENSION b2 LOCATED ABOVE THE DAMBAR PORTION OF MIDDLE LEAD.

DIM	MILLIMETERS		
	MIN.	NOM.	MAX.
A	3.75	3.90	4.05
A1	1.28	1.43	1.58
b	0.38	0.465	0.55
b2	0.62	0.70	0.78
c	0.35	0.40	0.45
D	7.85	8.00	8.15
E	4.75	4.90	5.05
E2	3.90	---	---
e	2.50 BSC		
L	13.80	14.00	14.20
L2	13.20	13.60	14.00
L3	3.00 REF		

STYLES AND MARKING ON PAGE 3

DOCUMENT NUMBER:	98AON52857E	Electronic versions are uncontrolled except when accessed directly from the Document Repository. Printed versions are uncontrolled except when stamped "CONTROLLED COPY" in red.
DESCRIPTION:	TO-92 (TO-226) 1 WATT	PAGE 2 OF 3

ON Semiconductor and  are trademarks of Semiconductor Components Industries, LLC dba ON Semiconductor or its subsidiaries in the United States and/or other countries. ON Semiconductor reserves the right to make changes without further notice to any products herein. ON Semiconductor makes no warranty, representation or guarantee regarding the suitability of its products for any particular purpose, nor does ON Semiconductor assume any liability arising out of the application or use of any product or circuit, and specifically disclaims any and all liability, including without limitation special, consequential or incidental damages. ON Semiconductor does not convey any license under its patent rights nor the rights of others.

**TO-92 (TO-226) 1 WATT
CASE 29-10
ISSUE D**

DATE 05 MAR 2021

- | | | | | |
|-----------------------------------------------------------------------------|--------------------------------------------------------------------------------|----------------------------------------------------------------------------|---------------------------------------------------------------------------|-----------------------------------------------------------------------|
| <p>STYLE 1:
PIN 1. EMITTER
2. BASE
3. COLLECTOR</p> | <p>STYLE 2:
PIN 1. BASE
2. EMITTER
3. COLLECTOR</p> | <p>STYLE 3:
PIN 1. ANODE
2. ANODE
3. CATHODE</p> | <p>STYLE 4:
PIN 1. CATHODE
2. CATHODE
3. ANODE</p> | <p>STYLE 5:
PIN 1. DRAIN
2. SOURCE
3. GATE</p> |
| <p>STYLE 6:
PIN 1. GATE
2. SOURCE & SUBSTRATE
3. DRAIN</p> | <p>STYLE 7:
PIN 1. SOURCE
2. DRAIN
3. GATE</p> | <p>STYLE 8:
PIN 1. DRAIN
2. GATE
3. SOURCE & SUBSTRATE</p> | <p>STYLE 9:
PIN 1. BASE 1
2. EMITTER
3. BASE 2</p> | <p>STYLE 10:
PIN 1. CATHODE
2. GATE
3. ANODE</p> |
| <p>STYLE 11:
PIN 1. ANODE
2. CATHODE & ANODE
3. CATHODE</p> | <p>STYLE 12:
PIN 1. MAIN TERMINAL 1
2. GATE
3. MAIN TERMINAL 2</p> | <p>STYLE 13:
PIN 1. ANODE 1
2. GATE
3. CATHODE 2</p> | <p>STYLE 14:
PIN 1. EMITTER
2. COLLECTOR
3. BASE</p> | <p>STYLE 15:
PIN 1. ANODE 1
2. CATHODE
3. ANODE 2</p> |
| <p>STYLE 16:
PIN 1. ANODE
2. GATE
3. CATHODE</p> | <p>STYLE 17:
PIN 1. COLLECTOR
2. BASE
3. EMITTER</p> | <p>STYLE 18:
PIN 1. ANODE
2. CATHODE
3. NOT CONNECTED</p> | <p>STYLE 19:
PIN 1. GATE
2. ANODE
3. CATHODE</p> | <p>STYLE 20:
PIN 1. NOT CONNECTED
2. CATHODE
3. ANODE</p> |
| <p>STYLE 21:
PIN 1. COLLECTOR
2. EMITTER
3. BASE</p> | <p>STYLE 22:
PIN 1. SOURCE
2. GATE
3. DRAIN</p> | <p>STYLE 23:
PIN 1. GATE
2. SOURCE
3. DRAIN</p> | <p>STYLE 24:
PIN 1. EMITTER
2. COLLECTOR/ANODE
3. CATHODE</p> | <p>STYLE 25:
PIN 1. MT 1
2. GATE
3. MT 2</p> |
| <p>STYLE 26:
PIN 1. V_{CC}
2. GROUND 2
3. OUTPUT</p> | <p>STYLE 27:
PIN 1. MT
2. SUBSTRATE
3. MT</p> | <p>STYLE 28:
PIN 1. CATHODE
2. ANODE
3. GATE</p> | <p>STYLE 29:
PIN 1. NOT CONNECTED
2. ANODE
3. CATHODE</p> | <p>STYLE 30:
PIN 1. DRAIN
2. GATE
3. SOURCE</p> |
| <p>STYLE 31:
PIN 1. GATE
2. DRAIN
3. SOURCE</p> | <p>STYLE 32:
PIN 1. BASE
2. COLLECTOR
3. EMITTER</p> | <p>STYLE 33:
PIN 1. RETURN
2. INPUT
3. OUTPUT</p> | <p>STYLE 34:
PIN 1. INPUT
2. GROUND
3. LOGIC</p> | <p>STYLE 35:
PIN 1. GATE
2. COLLECTOR
3. EMITTER</p> |

**GENERIC
MARKING DIAGRAM***



- XXXX = Specific Device Code
 A = Assembly Location
 L = Wafer Lot
 Y = Year
 W = Work Week
 ▪ = Pb-Free Package

(Note: Microdot may be in either location)

*This information is generic. Please refer to device data sheet for actual part marking. Pb-Free indicator, "G" or microdot "▪", may or may not be present. Some products may not follow the Generic Marking.

DOCUMENT NUMBER:	98AON52857E	Electronic versions are uncontrolled except when accessed directly from the Document Repository. Printed versions are uncontrolled except when stamped "CONTROLLED COPY" in red.
DESCRIPTION:	TO-92 (TO-226) 1 WATT	PAGE 3 OF 3

ON Semiconductor and  are trademarks of Semiconductor Components Industries, LLC dba ON Semiconductor or its subsidiaries in the United States and/or other countries. ON Semiconductor reserves the right to make changes without further notice to any products herein. ON Semiconductor makes no warranty, representation or guarantee regarding the suitability of its products for any particular purpose, nor does ON Semiconductor assume any liability arising out of the application or use of any product or circuit, and specifically disclaims any and all liability, including without limitation special, consequential or incidental damages. ON Semiconductor does not convey any license under its patent rights nor the rights of others.

MECHANICAL CASE OUTLINE

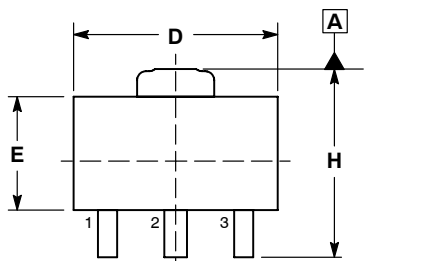
PACKAGE DIMENSIONS



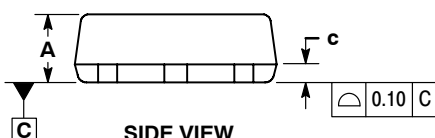
SCALE 2:1

SOT-89, 3 LEAD
CASE 528AG
ISSUE O

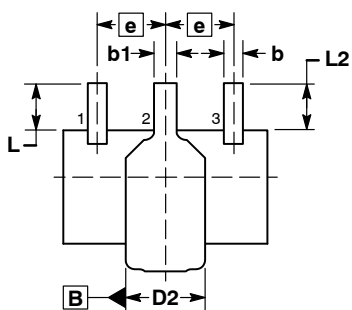
DATE 04 MAR 2014



TOP VIEW



SIDE VIEW



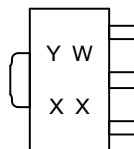
BOTTOM VIEW

NOTES:

1. DIMENSIONING AND TOLERANCING PER ASME Y14.5M, 1994.
2. CONTROLLING DIMENSION: MILLIMETERS.
3. LEAD THICKNESS INCLUDES LEAD FINISH.
4. DIMENSIONS D AND E DO NOT INCLUDE MOLD FLASH, PROTRUSIONS, OR GATE BURRS.
5. DIMENSIONS L, L2, D2, AND H ARE MEASURED AT DATUM PLANE C.
6. CENTER LEAD CONTOUR MAY VARY WITHIN THE REGION DEFINED BY DIMENSION E.
7. DIMENSION D2 IS DEFINED AT ITS WIDEST POINT.

MILLIMETERS		
DIM	MIN	MAX
A	1.40	1.60
b	0.38	0.47
b1	0.46	0.55
c	0.40	0.44
D	4.40	4.60
D2	1.60	1.90
E	2.40	2.60
e	1.50 BSC	
H	4.05	4.25
L	0.89	1.20

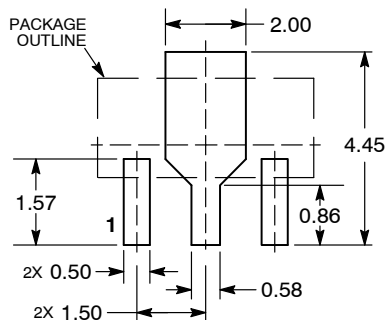
GENERIC MARKING DIAGRAM*



- Y = Year
- W = Work Week
- XX = Specific Device Code

*This information is generic. Please refer to device data sheet for actual part marking. Pb-Free indicator, "G" or microdot "•", may or may not be present. Some products may not follow the Generic Marking.

RECOMMENDED MOUNTING FOOTPRINT*



DIMENSIONS: MILLIMETERS

*For additional information on our Pb-Free strategy and soldering details, please download the ON Semiconductor Soldering and Mounting Techniques Reference Manual, SOLDERRM/D.

DOCUMENT NUMBER:	98AON82692F	Electronic versions are uncontrolled except when accessed directly from the Document Repository. Printed versions are uncontrolled except when stamped "CONTROLLED COPY" in red.
DESCRIPTION:	SOT-89, 3 LEAD	PAGE 1 OF 1

onsemi and ONSEMI are trademarks of Semiconductor Components Industries, LLC dba onsemi or its subsidiaries in the United States and/or other countries. onsemi reserves the right to make changes without further notice to any products herein. onsemi makes no warranty, representation or guarantee regarding the suitability of its products for any particular purpose, nor does onsemi assume any liability arising out of the application or use of any product or circuit, and specifically disclaims any and all liability, including without limitation special, consequential or incidental damages. onsemi does not convey any license under its patent rights nor the rights of others.

MECHANICAL CASE OUTLINE PACKAGE DIMENSIONS



SCALE 1:1

SOIC-8 NB
CASE 751-07
ISSUE AK

DATE 16 FEB 2011



- NOTES:
1. DIMENSIONING AND TOLERANCING PER ANSI Y14.5M, 1982.
 2. CONTROLLING DIMENSION: MILLIMETER.
 3. DIMENSION A AND B DO NOT INCLUDE MOLD PROTRUSION.
 4. MAXIMUM MOLD PROTRUSION 0.15 (0.006) PER SIDE.
 5. DIMENSION D DOES NOT INCLUDE DAMBAR PROTRUSION. ALLOWABLE DAMBAR PROTRUSION SHALL BE 0.127 (0.005) TOTAL IN EXCESS OF THE D DIMENSION AT MAXIMUM MATERIAL CONDITION.
 6. 751-01 THRU 751-06 ARE OBSOLETE. NEW STANDARD IS 751-07.

DIM	MILLIMETERS		INCHES	
	MIN	MAX	MIN	MAX
A	4.80	5.00	0.189	0.197
B	3.80	4.00	0.150	0.157
C	1.35	1.75	0.053	0.069
D	0.33	0.51	0.013	0.020
G	1.27 BSC		0.050 BSC	
H	0.10	0.25	0.004	0.010
J	0.19	0.25	0.007	0.010
K	0.40	1.27	0.016	0.050
M	0°	8°	0°	8°
N	0.25	0.50	0.010	0.020
S	5.80	6.20	0.228	0.244

GENERIC MARKING DIAGRAM*

SOLDERING FOOTPRINT*



XXXXX = Specific Device Code
A = Assembly Location
L = Wafer Lot
Y = Year
W = Work Week
▪ = Pb-Free Package

XXXXXX = Specific Device Code
A = Assembly Location
Y = Year
WW = Work Week
▪ = Pb-Free Package

*This information is generic. Please refer to device data sheet for actual part marking. Pb-Free indicator, "G" or microdot "▪", may or may not be present. Some products may not follow the Generic Marking.

*For additional information on our Pb-Free strategy and soldering details, please download the ON Semiconductor Soldering and Mounting Techniques Reference Manual, SOLDERRM/D.

STYLES ON PAGE 2

DOCUMENT NUMBER:	98ASB42564B	Electronic versions are uncontrolled except when accessed directly from the Document Repository. Printed versions are uncontrolled except when stamped "CONTROLLED COPY" in red.
DESCRIPTION:	SOIC-8 NB	PAGE 1 OF 2

onsemi and ONSEMI are trademarks of Semiconductor Components Industries, LLC dba onsemi or its subsidiaries in the United States and/or other countries. onsemi reserves the right to make changes without further notice to any products herein. onsemi makes no warranty, representation or guarantee regarding the suitability of its products for any particular purpose, nor does onsemi assume any liability arising out of the application or use of any product or circuit, and specifically disclaims any and all liability, including without limitation special, consequential or incidental damages. onsemi does not convey any license under its patent rights nor the rights of others.

SOIC-8 NB
CASE 751-07
ISSUE AK

DATE 16 FEB 2011

- | | | | |
|--------------------------------------------------------------------------------------------------------------------------------------------------------------------------------------------------------------------------|-----------------------------------------------------------------------------------------------------------------------------------------------------------------------------------------------------------------|-----------------------------------------------------------------------------------------------------------------------------------------------------------------------------------------------------------|-------------------------------------------------------------------------------------------------------------------------------------------------------------------------------------------------------------------------------|
| <p>STYLE 1:
 PIN 1. EMITTER
 2. COLLECTOR
 3. COLLECTOR
 4. EMITTER
 5. EMITTER
 6. BASE
 7. BASE
 8. EMITTER</p> | <p>STYLE 2:
 PIN 1. COLLECTOR, DIE, #1
 2. COLLECTOR, #1
 3. COLLECTOR, #2
 4. COLLECTOR, #2
 5. BASE, #2
 6. EMITTER, #2
 7. BASE, #1
 8. EMITTER, #1</p> | <p>STYLE 3:
 PIN 1. DRAIN, DIE #1
 2. DRAIN, #1
 3. DRAIN, #2
 4. DRAIN, #2
 5. GATE, #2
 6. SOURCE, #2
 7. GATE, #1
 8. SOURCE, #1</p> | <p>STYLE 4:
 PIN 1. ANODE
 2. ANODE
 3. ANODE
 4. ANODE
 5. ANODE
 6. ANODE
 7. ANODE
 8. COMMON CATHODE</p> |
| <p>STYLE 5:
 PIN 1. DRAIN
 2. DRAIN
 3. DRAIN
 4. DRAIN
 5. GATE
 6. GATE
 7. SOURCE
 8. SOURCE</p> | <p>STYLE 6:
 PIN 1. SOURCE
 2. DRAIN
 3. DRAIN
 4. SOURCE
 5. SOURCE
 6. GATE
 7. GATE
 8. SOURCE</p> | <p>STYLE 7:
 PIN 1. INPUT
 2. EXTERNAL BYPASS
 3. THIRD STAGE SOURCE
 4. GROUND
 5. DRAIN
 6. GATE 3
 7. SECOND STAGE Vd
 8. FIRST STAGE Vd</p> | <p>STYLE 8:
 PIN 1. COLLECTOR, DIE #1
 2. BASE, #1
 3. BASE, #2
 4. COLLECTOR, #2
 5. COLLECTOR, #2
 6. EMITTER, #2
 7. EMITTER, #1
 8. COLLECTOR, #1</p> |
| <p>STYLE 9:
 PIN 1. EMITTER, COMMON
 2. COLLECTOR, DIE #1
 3. COLLECTOR, DIE #2
 4. EMITTER, COMMON
 5. EMITTER, COMMON
 6. BASE, DIE #2
 7. BASE, DIE #1
 8. EMITTER, COMMON</p> | <p>STYLE 10:
 PIN 1. GROUND
 2. BIAS 1
 3. OUTPUT
 4. GROUND
 5. GROUND
 6. BIAS 2
 7. INPUT
 8. GROUND</p> | <p>STYLE 11:
 PIN 1. SOURCE 1
 2. GATE 1
 3. SOURCE 2
 4. GATE 2
 5. DRAIN 2
 6. DRAIN 2
 7. DRAIN 1
 8. DRAIN 1</p> | <p>STYLE 12:
 PIN 1. SOURCE
 2. SOURCE
 3. SOURCE
 4. GATE
 5. DRAIN
 6. DRAIN
 7. DRAIN
 8. DRAIN</p> |
| <p>STYLE 13:
 PIN 1. N.C.
 2. SOURCE
 3. SOURCE
 4. GATE
 5. DRAIN
 6. DRAIN
 7. DRAIN
 8. DRAIN</p> | <p>STYLE 14:
 PIN 1. N-SOURCE
 2. N-GATE
 3. P-SOURCE
 4. P-GATE
 5. P-DRAIN
 6. P-DRAIN
 7. N-DRAIN
 8. N-DRAIN</p> | <p>STYLE 15:
 PIN 1. ANODE 1
 2. ANODE 1
 3. ANODE 1
 4. ANODE 1
 5. CATHODE, COMMON
 6. CATHODE, COMMON
 7. CATHODE, COMMON
 8. CATHODE, COMMON</p> | <p>STYLE 16:
 PIN 1. EMITTER, DIE #1
 2. BASE, DIE #1
 3. EMITTER, DIE #2
 4. BASE, DIE #2
 5. COLLECTOR, DIE #2
 6. COLLECTOR, DIE #2
 7. COLLECTOR, DIE #1
 8. COLLECTOR, DIE #1</p> |
| <p>STYLE 17:
 PIN 1. VCC
 2. V2OUT
 3. V1OUT
 4. TXE
 5. RXE
 6. VEE
 7. GND
 8. ACC</p> | <p>STYLE 18:
 PIN 1. ANODE
 2. ANODE
 3. SOURCE
 4. GATE
 5. DRAIN
 6. DRAIN
 7. CATHODE
 8. CATHODE</p> | <p>STYLE 19:
 PIN 1. SOURCE 1
 2. GATE 1
 3. SOURCE 2
 4. GATE 2
 5. DRAIN 2
 6. MIRROR 2
 7. DRAIN 1
 8. MIRROR 1</p> | <p>STYLE 20:
 PIN 1. SOURCE (N)
 2. GATE (N)
 3. SOURCE (P)
 4. GATE (P)
 5. DRAIN
 6. DRAIN
 7. DRAIN
 8. DRAIN</p> |
| <p>STYLE 21:
 PIN 1. CATHODE 1
 2. CATHODE 2
 3. CATHODE 3
 4. CATHODE 4
 5. CATHODE 5
 6. COMMON ANODE
 7. COMMON ANODE
 8. CATHODE 6</p> | <p>STYLE 22:
 PIN 1. I/O LINE 1
 2. COMMON CATHODE/VCC
 3. COMMON CATHODE/VCC
 4. I/O LINE 3
 5. COMMON ANODE/GND
 6. I/O LINE 4
 7. I/O LINE 5
 8. COMMON ANODE/GND</p> | <p>STYLE 23:
 PIN 1. LINE 1 IN
 2. COMMON ANODE/GND
 3. COMMON ANODE/GND
 4. LINE 2 IN
 5. LINE 2 OUT
 6. COMMON ANODE/GND
 7. COMMON ANODE/GND
 8. LINE 1 OUT</p> | <p>STYLE 24:
 PIN 1. BASE
 2. EMITTER
 3. COLLECTOR/ANODE
 4. COLLECTOR/ANODE
 5. CATHODE
 6. CATHODE
 7. COLLECTOR/ANODE
 8. COLLECTOR/ANODE</p> |
| <p>STYLE 25:
 PIN 1. VIN
 2. N/C
 3. REXT
 4. GND
 5. IOUT
 6. IOUT
 7. IOUT
 8. IOUT</p> | <p>STYLE 26:
 PIN 1. GND
 2. dv/dt
 3. ENABLE
 4. ILIMIT
 5. SOURCE
 6. SOURCE
 7. SOURCE
 8. VCC</p> | <p>STYLE 27:
 PIN 1. ILIMIT
 2. OVLO
 3. UVLO
 4. INPUT+
 5. SOURCE
 6. SOURCE
 7. SOURCE
 8. DRAIN</p> | <p>STYLE 28:
 PIN 1. SW_TO_GND
 2. DASIC_OFF
 3. DASIC_SW_DET
 4. GND
 5. V_MON
 6. VBULK
 7. VBULK
 8. VIN</p> |
| <p>STYLE 29:
 PIN 1. BASE, DIE #1
 2. EMITTER, #1
 3. BASE, #2
 4. EMITTER, #2
 5. COLLECTOR, #2
 6. COLLECTOR, #2
 7. COLLECTOR, #1
 8. COLLECTOR, #1</p> | <p>STYLE 30:
 PIN 1. DRAIN 1
 2. DRAIN 1
 3. GATE 2
 4. SOURCE 2
 5. SOURCE 1/DRAIN 2
 6. SOURCE 1/DRAIN 2
 7. SOURCE 1/DRAIN 2
 8. GATE 1</p> | | |

DOCUMENT NUMBER:	98ASB42564B	Electronic versions are uncontrolled except when accessed directly from the Document Repository. Printed versions are uncontrolled except when stamped "CONTROLLED COPY" in red.
DESCRIPTION:	SOIC-8 NB	PAGE 2 OF 2

onsemi and **ONSEMI** are trademarks of Semiconductor Components Industries, LLC dba **onsemi** or its subsidiaries in the United States and/or other countries. **onsemi** reserves the right to make changes without further notice to any products herein. **onsemi** makes no warranty, representation or guarantee regarding the suitability of its products for any particular purpose, nor does **onsemi** assume any liability arising out of the application or use of any product or circuit, and specifically disclaims any and all liability, including without limitation special, consequential or incidental damages. **onsemi** does not convey any license under its patent rights nor the rights of others.

onsemi, **Onsemi**, and other names, marks, and brands are registered and/or common law trademarks of Semiconductor Components Industries, LLC dba "**onsemi**" or its affiliates and/or subsidiaries in the United States and/or other countries. **onsemi** owns the rights to a number of patents, trademarks, copyrights, trade secrets, and other intellectual property. A listing of **onsemi**'s product/patent coverage may be accessed at www.onsemi.com/site/pdf/Patent-Marking.pdf. **onsemi** reserves the right to make changes at any time to any products or information herein, without notice. The information herein is provided "as-is" and **onsemi** makes no warranty, representation or guarantee regarding the accuracy of the information, product features, availability, functionality, or suitability of its products for any particular purpose, nor does **onsemi** assume any liability arising out of the application or use of any product or circuit, and specifically disclaims any and all liability, including without limitation special, consequential or incidental damages. Buyer is responsible for its products and applications using **onsemi** products, including compliance with all laws, regulations and safety requirements or standards, regardless of any support or applications information provided by **onsemi**. "Typical" parameters which may be provided in **onsemi** data sheets and/or specifications can and do vary in different applications and actual performance may vary over time. All operating parameters, including "Typicals" must be validated for each customer application by customer's technical experts. **onsemi** does not convey any license under any of its intellectual property rights nor the rights of others. **onsemi** products are not designed, intended, or authorized for use as a critical component in life support systems or any FDA Class 3 medical devices or medical devices with a same or similar classification in a foreign jurisdiction or any devices intended for implantation in the human body. Should Buyer purchase or use **onsemi** products for any such unintended or unauthorized application, Buyer shall indemnify and hold **onsemi** and its officers, employees, subsidiaries, affiliates, and distributors harmless against all claims, costs, damages, and expenses, and reasonable attorney fees arising out of, directly or indirectly, any claim of personal injury or death associated with such unintended or unauthorized use, even if such claim alleges that **onsemi** was negligent regarding the design or manufacture of the part. **onsemi** is an Equal Opportunity/Affirmative Action Employer. This literature is subject to all applicable copyright laws and is not for resale in any manner.

PUBLICATION ORDERING INFORMATION

LITERATURE FULFILLMENT:

Email Requests to: orderlit@onsemi.com

onsemi Website: www.onsemi.com

TECHNICAL SUPPORT

North American Technical Support:

Voice Mail: 1 800-282-9855 Toll Free USA/Canada

Phone: 011 421 33 790 2910

Europe, Middle East and Africa Technical Support:

Phone: 00421 33 790 2910

For additional information, please contact your local Sales Representative

