

# Keysight U1273A/U1273AX Handheld Digital Multimeter



NOTICE: This document contains references to Agilent Technologies. Agilent's former Test and Measurement business has become Keysight Technologies. For more information, go to [www.keysight.com](http://www.keysight.com).



# Notices

## Copyright Notice

© Keysight Technologies 2012–2021  
No part of this manual may be reproduced in any form or by any means (including electronic storage and retrieval or translation into a foreign language) without prior agreement and written consent from Keysight Technologies as governed by United States and international copyright laws.

## Manual Part Number

U1273-90017

## Edition

Edition 11, February 2021

## Printed in:

Printed in Malaysia

## Published by:

Keysight Technologies  
Bayan Lepas Free Industrial Zone,  
11900 Penang, Malaysia

## Technology Licenses

The hardware and/or software described in this document are furnished under a license and may be used or copied only in accordance with the terms of such license.

## Declaration of Conformity

Declarations of Conformity for this product and for other Keysight products may be downloaded from the Web. Go to <http://www.keysight.com/go/conformity>. You can then search by product number to find the latest Declaration of Conformity.

## U.S. Government Rights

The Software is “commercial computer software,” as defined by Federal Acquisition Regulation (“FAR”) 2.101. Pursuant to FAR 12.212 and 27.405-3 and Department of Defense FAR Supplement (“DFARS”) 227.7202, the U.S. government acquires commercial computer software under the same terms by which the software is customarily provided to the public. Accordingly, Keysight provides the Software to U.S. government customers under its standard commercial license, which is embodied in its End User License Agreement (EULA), a copy of which can be found at <http://www.keysight.com/find/sweula>. The license set forth in the EULA represents the exclusive authority by which the U.S. government may use, modify, distribute, or disclose the Software. The EULA and the license set forth therein, does not require or permit, among other things, that Keysight: (1) Furnish technical information related to commercial computer software or commercial computer software documentation that is not customarily provided to the public; or (2) Relinquish to, or otherwise provide, the government rights in excess of these rights customarily provided to the public to use, modify, reproduce, release, perform, display, or disclose commercial computer software or commercial computer software documentation. No additional government requirements beyond those set forth in the EULA shall apply, except to the extent that those terms, rights, or licenses are explicitly required from all providers of commercial computer software pursuant to the FAR and the DFARS and are set forth specifically in writing elsewhere in the EULA. Keysight shall be under no obligation to update, revise or otherwise modify the Software. With respect to any technical data as defined by FAR 2.101, pursuant to FAR 12.211 and 27.404.2 and DFARS 227.7102, the U.S. government acquires no greater than Limited Rights as defined in FAR 27.401 or DFAR 227.7103-5 (c), as applicable in any technical data.

## Warranty

THE MATERIAL CONTAINED IN THIS DOCUMENT IS PROVIDED “AS IS,” AND IS SUBJECT TO BEING CHANGED, WITHOUT NOTICE, IN FUTURE EDITIONS. FURTHER, TO THE MAXIMUM EXTENT PERMITTED BY APPLICABLE LAW, KEYSIGHT DISCLAIMS ALL WARRANTIES, EITHER EXPRESS OR IMPLIED, WITH REGARD TO THIS MANUAL AND ANY INFORMATION CONTAINED HEREIN, INCLUDING BUT NOT LIMITED TO THE IMPLIED WARRANTIES OF MERCHANTABILITY AND FITNESS FOR A PARTICULAR PURPOSE. KEYSIGHT SHALL NOT BE LIABLE FOR ERRORS OR FOR INCIDENTAL OR CONSEQUENTIAL DAMAGES IN CONNECTION WITH THE FURNISHING, USE, OR PERFORMANCE OF THIS DOCUMENT OR OF ANY INFORMATION CONTAINED HEREIN. SHOULD KEYSIGHT AND THE USER HAVE A SEPARATE WRITTEN AGREEMENT WITH WARRANTY TERMS COVERING THE MATERIAL IN THIS DOCUMENT THAT CONFLICT WITH THESE TERMS, THE WARRANTY TERMS IN THE SEPARATE AGREEMENT SHALL CONTROL.

## Safety Information

### CAUTION









A CAUTION notice denotes a hazard. It calls attention to an operating procedure, practice, or the like that, if not correctly performed or adhered to, could result in damage to the product or loss of important data. Do not proceed beyond a CAUTION notice until the indicated conditions are fully understood and met.

### WARNING

A WARNING notice denotes a hazard. It calls attention to an operating procedure, practice, or the like that, if not correctly performed or adhered to, could result in personal injury or death. Do not proceed beyond a WARNING notice until the indicated conditions are fully understood and met.

## Safety Symbols

The following symbols on the instrument and in the documentation indicate precautions which must be taken to maintain safe operation of the instrument.

 Direct current (DC)	 Caution, risk of electric shock
 Alternating current (AC)	 Caution, risk of danger (refer to this manual for specific Warning or Caution information)
 Earth (ground) terminal	<b>CAT III</b> <b>1000 V</b> Category III 1000 V overvoltage protection
 Equipment protected throughout by double insulation or reinforced insulation	<b>CAT IV</b> <b>600 V</b> Category IV 600 V overvoltage protection
 Fuse	 Battery, general

## Safety Considerations

Read the information below before using this multimeter. The descriptions and instructions in this manual apply to the Keysight U1273A/U1273AX Handheld Digital Multimeter (hereafter referred to as the multimeter).

### CAUTION

- Disconnect circuit power and discharge all high-voltage capacitors before testing resistance, continuity, diodes, or capacitance.
  - Use the proper terminals, function, and range for your measurements.
  - This device is for use at altitudes of up to 3,000 m.
  - Never measure voltage when current measurement is selected.
  - Always use the specified battery type. The power for the multimeter is supplied with four AAA 1.5 V batteries. Observe the correct polarity markings before you insert the batteries to ensure proper insertion of the batteries in the multimeter.
  - You are advised to use low leakage batteries when changing to new batteries. Please remember to remove the batteries when the multimeter is not in use for a long period of time. Warning on the risk of battery leakage.
- 

### WARNING

- Do not exceed any of the measurement limits defined in the specifications to avoid instrument damage and the risk of electric shock.
  - Do not use the multimeter if it is damaged. Before you use the multimeter, inspect the case. Look for cracks or missing plastic. Pay particular attention to the insulation surrounding the connectors.
  - Inspect the test leads for damaged insulation or exposed metal. Check the test leads for continuity. Replace damaged test leads before you use the multimeter.
  - Do not operate the multimeter around explosive gas, vapor, or wet environments.
  - Do not apply more than the rated voltage (as marked on the multimeter) between terminals, or between terminal and earth ground.
-

**WARNING**

- Never use the multimeter in wet conditions or when there is water on the surface. If the multimeter is wet, ensure that the multimeter is dried only by trained personnel.
  - Before use, verify the multimeter's operation by measuring a known voltage.
  - When measuring current, turn off the circuit power before connecting the multimeter in the circuit. Remember to place the multimeter in series with the circuit.
  - When servicing the multimeter, use only the specified replacement parts.
  - Use caution when working above 60 VDC, 30 VAC RMS, or 42.4 V peak. Such voltages pose a shock hazard.
  - Be aware of the presence of hazardous AC voltage before using the Low Pass Filter (LPF) function for AC voltage measurement. Voltages measured are usually greater than what is indicated on the multimeter as the AC voltages with higher frequencies have been filtered through the LPF function.
  - Do not use the  $Z_{LOW}$  (low input impedance) function to measure voltages in circuits that could be damaged by this function's low input impedance of 2 k $\Omega$  (nominal).
  - When using the probes, keep your fingers behind the finger guards on the probes.
  - Connect the common test lead before you connect the live test lead. When you disconnect the leads, disconnect the live test lead first.
  - Remove the test leads from the multimeter before you open the battery cover.
  - Do not operate the multimeter with the battery cover or portions of the cover removed or loosened.
  - To avoid false readings, which may lead to possible electric shock or personal injury, replace the battery as soon as the low battery indicator appears and flashes.
-

## Measurement Category

The Keysight U1273A/U1273AX has a safety rating of CAT III, 1000 V and CAT IV, 600 V.

**Measurement CAT I** Measurements performed on circuits not directly connected to the AC mains. Examples are measurements on circuits not derived from the AC mains and specially protected (internal) mains-derived circuits.

**Measurement CAT II** Measurements performed on circuits directly connected to a low-voltage installation. Examples are measurements on household appliances, portable tools, and similar equipment.

**Measurement CAT III** Measurements performed in the building installation. Examples are measurements on distribution boards, circuit-breakers, wiring, including cables, bus-bars, junction boxes, switches, socket outlets in the fixed installation, and equipment for industrial use, and some other equipment including stationary motors with permanent connection to the fixed installation.

**Measurement CAT IV** Measurements performed at the source of the low-voltage installation. Examples are electricity meters and measurements on primary overcurrent protection devices and ripple control units.

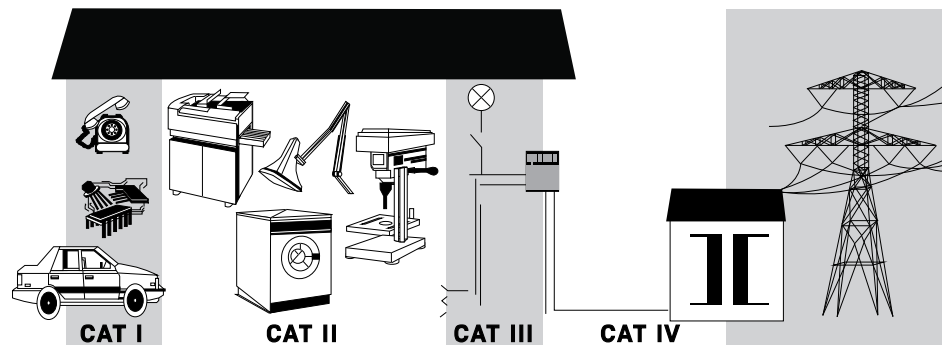



## Environmental Conditions

This instrument is designed for indoor use and in an area with low condensation. The table below shows the general environmental requirements for this instrument.

Environmental conditions	Requirements
Operating temperature	<ul style="list-style-type: none"><li>- <b>U1273A:</b> -20 °C to 55 °C, 0% to 80% RH</li><li>- <b>U1273AX:</b> -40 °C to 55 °C, 0% to 80% RH (using Lithium batteries)</li></ul>
Operating humidity	Full accuracy up to 80% RH (relative humidity) for temperature up to 30 °C, decreasing linearly to 50% RH at 55 °C
Storage temperature	-40 °C to 70 °C
Altitude	Up to 3000 meters
Pollution degree	Pollution degree II





### NOTE

The U1273A/U1273AX Handheld Digital Multimeter complies with the following safety and EMC requirements:

- **Safety**
  - EN/IEC 61010-1
  - UL Std. No. 61010-1/61010-2-033
  - CAN/CSA-C22.2 No. 61010-1/61010-2-033
- **EMC**
  - IEC61326-1/EN61326-1
  - Canada: ICES/NMB-001
  - Australia/New Zealand: AS/NZS CISPR 11

Refer to Declaration of Conformity for current revisions. Go to <http://www.keysight.com/go/conformity> for more information.

## Regulatory Markings

 <p>The CE mark is a registered trademark of the European Community. This CE mark shows that the product complies with all the relevant European Legal Directives.</p>	 <p>The RCM mark is a registered trademark of the Australian Communications and Media Authority.</p>
<p><b>ICES/NMB-001</b></p> <p>ICES/NMB-001 indicates that this ISM device complies with the Canadian ICES-001. Cet appareil ISM est conforme a la norme NMB-001 du Canada.</p>	 <p>This instrument complies with the WEEE Directive (2002/96/EC) marking requirement. This affixed product label indicates that you must not discard this electrical or electronic product in domestic household waste.</p>
 <p>The CSA mark is a registered trademark of the Canadian Standards Association.</p>	 <p>This symbol indicates the time period during which no hazardous or toxic substance elements are expected to leak or deteriorate during normal use. Forty years is the expected useful life of the product.</p>

## Waste Electrical and Electronic Equipment (WEEE) Directive 2002/96/EC

This instrument complies with the WEEE Directive (2002/96/EC) marking requirement. This affixed product label indicates that you must not discard this electrical or electronic product in domestic household waste.

### Product category:

With reference to the equipment types in the WEEE directive Annex 1, this instrument is classified as a “Monitoring and Control Instrument” product.

The affixed product label is as shown below.



Do not dispose in domestic household waste.

To return this unwanted instrument, contact your nearest Keysight Service Center, or visit <http://about.keysight.com/en/companyinfo/environment/takeback.shtml> for more information.

## Sales and Technical Support

To contact Keysight for sales and technical support, refer to the support links on the following Keysight websites:

- [www.keysight.com/find/handheldmm](http://www.keysight.com/find/handheldmm)  
(product-specific information and support, software and documentation updates)
- [www.keysight.com/find/assist](http://www.keysight.com/find/assist)  
(worldwide contact information for repair and service)

THIS PAGE HAS BEEN INTENTIONALLY LEFT BLANK.

# Table of Contents

Safety Symbols	5
Safety Considerations	6
Measurement Category	8
Environmental Conditions	9
Regulatory Markings	10
Waste Electrical and Electronic Equipment (WEEE) Directive 2002/96/ EC	11
Product category:	11
Sales and Technical Support	11
<b>1 Introduction</b>	
About This Manual	22
Documentation map	22
Safety notes	22
Preparing Your Multimeter	23
Check the shipment	23
Install the batteries	23
Turn on your multimeter	26
Automatic power-off	26
OLED Auto Dim function	27
Increase the OLED brightness	27
Select the range	27
Alerts and warnings during measurement	28
Adjust the tilt stand	30
Connect the IR-USB cable	30
Power-on options	32
Your Multimeter in Brief	33
Dimensions	33
Overview	35
Rotary switch	37
Keypad	39

Display screen	44
Input terminals	50
Cleaning Your Multimeter	52
<b>2 Making Measurements</b>	
Crest Factor	54
Measuring AC Voltage	55
Using the LPF (Low Pass Filter) function for AC measurements	57
Measuring DC Voltage	58
Using the Filter Function for DC measurements	61
Measuring AC and DC Signals	62
Using the LPF (Low Pass Filter) Function for AC+DC measurements	64
Making dB Measurements	64
Using Z <sub>LOW</sub> for Voltage Measurements	67
Measuring Resistance	69
Measuring conductance	72
Testing for Continuity	73
Using Smart $\Omega$ for Resistance Measurements	76
Testing Diodes	79
Using Auto-diode for Diode Tests	83
Measuring Capacitance	85
Measuring Temperature	87
Measuring AC or DC Current	91
% Scale of 4-20 mA or 0-20 mA	97
Measuring Frequency	100
Measuring pulse width	103
Measuring duty cycle	104
<b>3 Multimeter Features</b>	
Making Relative Measurements (Null)	106
Making Scale Transfers (Scale)	108

Capturing Maximum and Minimum Values (MaxMin)	110
Capturing Peak Values (Peak)	112
Freezing the Display (TrigHold and AutoHold)	114
Recording Measurement Data (Data Logging)	115
Performing manual logs (HAND)	116
Performing interval logs (AUTO)	116
Performing event logs (TRIG)	118
Reviewing Previously Recorded Data (View)	120
Sanitizing the Log Memories	121
<b>4 Multimeter Setup Options</b>	
Using the Setup Menu	124
Editing numerical values	125
Setup Menu Summary	127
Setup Menu Items	132
Changing the variation count	132
Changing the recording option	132
Changing the sample interval duration	133
Changing the decibel display	133
Changing the custom dBm reference impedance	134
Changing the thermocouple type	135
Changing the temperature unit	135
Changing the % scale range	136
Changing the continuity alert	137
Changing the minimum measurable frequency	137
Changing the beep frequency	138
Changing the auto power-off (APO) timer	138
Changing the OLED behavior	139
Changing the power-on melody	139
Changing the power-on greetings	140
Changing the baud rate	141
Changing the data bits	141
Changing the parity check	142
Enabling the echo feature	142

Enabling the print feature	143
Enabling the overvoltage alert	143
Changing the user scale conversion value and unit	144
Enabling smooth mode	144
Resetting the multimeter's setup options	145
Changing the battery type	146
Enabling the filter	146
<b>5 Characteristics and Specifications</b>	
<b>A Shift Functions Using the Shift Key</b>	
<b>B Dual Display Combinations Using the Dual Key</b>	



## List of Figures

Figure 1-1	Installing the batteries . . . . .	24
Figure 1-2	Change battery display . . . . .	25
Figure 1-3	Input warning display (A INPUT) . . . . .	29
Figure 1-4	Input warning display (mA INPUT) . . . . .	29
Figure 1-5	Tilt-stand adjustment and IR-USB cable connection . . . . .	30
Figure 1-6	Keysight GUI Data Logger Software . . . . .	31
Figure 1-7	Width dimensions. . . . .	33
Figure 1-8	Height and depth dimensions . . . . .	34
Figure 1-9	Front panel . . . . .	35
Figure 1-10	Rear panel . . . . .	36
Figure 1-11	U1273A/U1273AX rotary switch . . . . .	37
Figure 1-12	Keys . . . . .	39
Figure 1-13	Display screen example (single display) . . . . .	44
Figure 1-14	Display screen example (dual display) . . . . .	44
Figure 1-15	Connector terminals. . . . .	50
Figure 2-1	AC voltage display . . . . .	55
Figure 2-2	Measuring AC voltage . . . . .	56
Figure 2-3	AC voltage with LPF display. . . . .	57
Figure 2-4	DC voltage display . . . . .	58
Figure 2-5	Measuring DC voltage . . . . .	60
Figure 2-6	Filter for DC voltage measurements . . . . .	61
Figure 2-7	AC+DC voltage display. . . . .	63
Figure 2-8	AC+DC current display. . . . .	63
Figure 2-9	Low Pass Filter(LPF) for AC+DC voltage measurements . . . . .	64
Figure 2-10	dBm display . . . . .	65
Figure 2-11	dBV display. . . . .	67
Figure 2-12	Z <sub>LOW</sub> display. . . . .	68
Figure 2-13	Resistance display . . . . .	70
Figure 2-14	Measuring resistance. . . . .	71
Figure 2-15	Continuity operation. . . . .	74
Figure 2-16	Testing for continuity . . . . .	75
Figure 2-17	Smart $\Omega$ (with bias voltage) display. . . . .	77
Figure 2-18	Smart $\Omega$ (with leakage current) display. . . . .	77
Figure 2-19	Measuring leakage current . . . . .	78

Figure 2-20	Diode display . . . . .	79
Figure 2-21	Open diode display . . . . .	80
Figure 2-22	Testing a forward-bias diode. . . . .	81
Figure 2-23	Testing a reverse-bias diode . . . . .	82
Figure 2-24	Auto-diode display (GOOD status) . . . . .	84
Figure 2-25	Auto-diode display (NGOOD status) . . . . .	84
Figure 2-26	Capacitance display. . . . .	85
Figure 2-27	Measuring capacitance . . . . .	86
Figure 2-28	Temperature display . . . . .	87
Figure 2-29	Measuring surface temperature . . . . .	89
Figure 2-30	Temperature measurement without ambient compensation . . . . .	90
Figure 2-31	DC current display . . . . .	92
Figure 2-32	Measuring DC current . . . . .	94
Figure 2-33	Measuring AC current . . . . .	95
Figure 2-34	Current measurement setup . . . . .	96
Figure 2-35	4-20 mA % Scale display. . . . .	97
Figure 2-36	Measuring DC current using the 0-20 mA % scale . . . .	99
Figure 2-37	Frequency, pulse width, and duty cycle measurements . . . . .	101
Figure 2-38	Frequency display . . . . .	102
Figure 2-39	Pulse width display . . . . .	103
Figure 2-40	Duty cycle display . . . . .	104
Figure 3-1	Null display . . . . .	106
Figure 3-2	Null operation . . . . .	107
Figure 3-3	Scale operation . . . . .	109
Figure 3-4	MaxMin display . . . . .	110
Figure 3-5	Peak display . . . . .	112
Figure 3-6	Peak mode operation. . . . .	113
Figure 3-7	Manual log display. . . . .	116
Figure 3-8	Interval log display. . . . .	117
Figure 3-9	Event log display . . . . .	119
Figure 3-10	View display . . . . .	120
Figure 3-11	Empty view display . . . . .	120

## List of Tables

Table 1-1	Power-on options	32
Table 1-2	Front panel parts	35
Table 1-3	Rear panel parts	36
Table 1-4	U1273A/U1273AX rotary switch functions	38
Table 1-5	Keypad functions	40
Table 1-6	General annunciators	45
Table 1-7	Measurement units display	48
Table 1-8	Analog bar graph display	49
Table 1-9	Terminal connections for different measuring functions	51
Table 2-1	Rotary switch positions allowing AC voltage measurements	55
Table 2-2	Rotary switch positions allowing AC voltage measurements with LPF	57
Table 2-3	Rotary switch positions allowing DC voltage measurements	58
Table 2-4	Rotary switch positions allowing AC+DC signal measurements	62
Table 2-5	Rotary switch positions allowing dBm measurements	65
Table 2-6	Rotary switch positions allowing dBV measurements	66
Table 2-7	Rotary switch positions allowing $Z_{LOW}$ measurements	67
Table 2-8	Rotary switch position allowing resistance measurements	69
Table 2-9	Rotary switch position allowing continuity tests	73
Table 2-10	Threshold resistance values	73
Table 2-11	Rotary switch position allowing Smart $\Omega$ measurements	76
Table 2-12	Rotary switch position allowing diode tests	79
Table 2-13	Rotary switch position allowing auto-diode tests	83
Table 2-14	Auto-diode voltage thresholds	83
Table 2-15	Rotary switch position allowing capacitance measurements	85
Table 2-16	Rotary switch position allowing temperature	

	measurements	87
Table 2-17	Rotary switch positions allowing current measurements	91
Table 2-18	Rotary switch positions allowing current measurements	97
Table 2-19	% Scale measurement range	98
Table 2-20	Rotary switch positions allowing frequency measurements	100
Table 3-1	Available scale conversions	108
Table 3-2	Data logging maximum capacity	115
Table 3-3	Event log trigger conditions	118
Table 4-1	Setup menu key functions	124
Table 4-2	Setup menu item descriptions	127
Table 4-3	Filter (LPF) options	147
Table 4-4	Firmware version 1.64 or older	147
Table 4-5	Firmware version 1.95 or newer	147
Table A-1	U1273A/U1273AX default and shift functions	152
Table B-1	U1273A/U1273AX dual display combinations	156

# 1 Introduction

About This Manual	22
Preparing Your Multimeter	23
Your Multimeter in Brief	33
Cleaning Your Multimeter	52

This chapter lists the package contents for the U1273A/U1273AX handheld digital multimeter and teaches you how to set up your multimeter for the first time. An introduction to all the features of the multimeter is also given.

## About This Manual

### Documentation map

The following manuals and software are available for your multimeter. For the very latest version, please visit our website at <http://www.keysight.com/find/hhTechLib>.

Check the manual revision on the first page of each manual.

- **User’s Guide.** This manual.
- **Quick Start Guide.** Free download at the Keysight website.
- **Service Guide.** Free download at the Keysight website.
- **Keysight GUI Data Logger Software, Help, and Quick Start Guide.** Free download at the Keysight website.

### Safety notes

The following safety notes are used throughout this manual. Familiarize yourself with each of the notes and its meaning before operating your multimeter. More pertinent safety notes for using this product are located under the “**Safety Symbols**” section.

#### CAUTION

Caution denotes a hazard. It calls attention to a procedure that, if not correctly performed or adhered to, could result in damage to or destruction of the product. Do not proceed beyond a caution notice until the indicated conditions are fully understood and met.

---

#### WARNING

Warning denotes a hazard. It calls attention to a procedure which, if not correctly performed or adhered to, could result in injury or loss of life. Do not proceed beyond a warning note until the indicated conditions are fully understood and met.

---

## Preparing Your Multimeter

### Check the shipment

When you receive your multimeter, check the shipment according to the following procedure.

- 1** Inspect the shipping container for damage. Signs of damage may include a dented or torn shipping container or cushioning material that indicates signs of unusual stress or compacting. Save the packaging material in case the multimeter needs to be returned.
- 2** Carefully remove the contents from the shipping container, and verify that the standard accessories and your ordered options are included in the shipment according to the standard shipped items as below:
  - Standard test leads
  - Test probes with 4 mm tips
  - K-type thermocouple and adapter
  - 4 x 1.5 V AAA alkaline batteries (for U1273A) or lithium batteries (for U1273AX)
  - Certificate of Calibration
- 3** For any question or problems, refer to the Keysight contact numbers on the back of this manual.

### Install the batteries

Your multimeter is powered by four 1.5 V AAA batteries (included with the shipment). When you receive your multimeter, the AAA batteries are not installed.

Use the following procedure to install the batteries.

#### CAUTION



Before you proceed with the batteries installation, remove all cable connections to the terminals and ensure that the rotary switch is at the OFF position. Use only the battery type specified in the datasheet at <http://literature.cdn.keysight.com/litweb/pdf>.

---

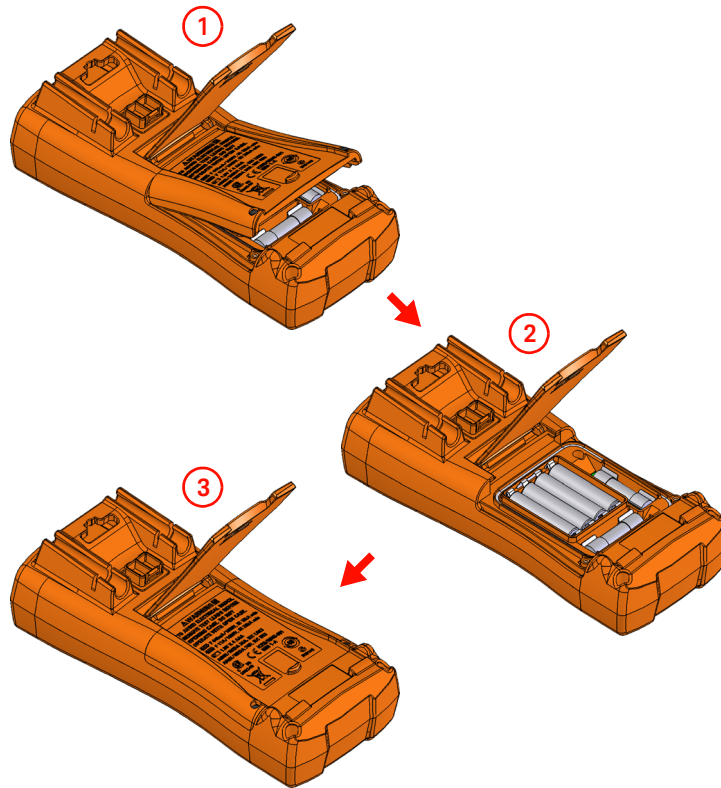
- 1 Open the battery cover.** Lift the tilt stand, loosen the screws with a suitable Phillips screwdriver, and remove the battery cover as shown in [Figure 1-1](#).
- 2 Insert the battery.** Observe the proper battery polarity. The terminal ends of each battery are indicated inside the battery compartment.
- 3 Close the battery cover.** Place the battery cover back in its original position and tighten the screws.



**Figure 1-1** Installing the batteries

The battery level indicator in the lower left-hand corner of the display indicates the relative condition of the batteries. Replace the batteries as soon as possible when the low battery indicator (  ↔  ) is shown.



When the **Change Battery** warning (Figure 1-2) is shown on the display, the multimeter will power-off automatically after 5 seconds (even if the APO feature is disabled).

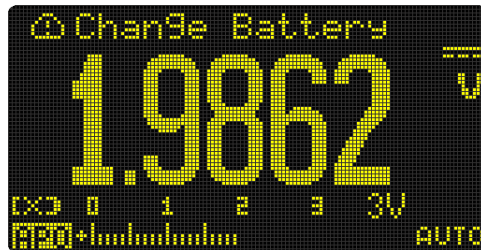

Figure 1-2 Change battery display

**WARNING**

To avoid false readings, which could lead to possible electric shock or personal injury, replace the battery as soon as the low battery indicator appears. Do not discharge the battery by shorting the battery or reverse the battery polarity in any of the subjects.

---

**CAUTION**

To avoid instruments being damage from battery leakage:

- Always remove dead batteries immediately.
  - Always remove the batteries and store them separately if the multimeter is not going to be used for a long period.
-

## Turn on your multimeter

To power ON your multimeter, turn the rotary switch to any other position.

To power OFF your multimeter, turn the rotary switch to the **OFF** position.

## Automatic power-off

Your multimeter automatically turns off if the rotary switch is not moved or a key is not pressed for 10 minutes (default). Pressing any key will turn the multimeter back on after it is powered off automatically.

To change the timer period or completely disable the automatic power-off, refer to [“Changing the auto power-off \(APO\) timer”](#) on page 138.

## OLED Auto Dim function

Your multimeter's OLED automatically dims if the rotary switch is not moved or a key is not pressed for 90 seconds (default). This auto dim behavior is enabled by default. Pressing any key or changing the rotary switch position will cancel this effect and reset the auto dim timer.

To disable the auto dim, refer to [“Changing the OLED behavior”](#) on page 139.

## Increase the OLED brightness

### NOTE

The auto dim function is enabled by default. Refer to [“Changing the OLED behavior”](#) on page 139 to disable the auto dim function before you can manually change the OLED brightness.

If viewing the display becomes difficult in low-light conditions, press  to change the OLED brightness.

The **LOW**, **MEDIUM**, or **HIGH** setting must be selected in the multimeter's setup (browse to **Menu 3 > BACKLIT**) prior to this action.

Pressing  repeatedly will increase the OLED brightness from low to medium to high (and back to low again).

You are advised to select a suitable brightness level based on your needs to conserve battery life if you wish to control the OLED brightness level manually.

## Select the range

The multimeter's selected range is always displayed above the right-hand end of the bar graph, as the range indicator. Pressing  switches the multimeter between manual and auto-ranging. It also cycles through the available multimeter ranges when manual ranging is enabled.

Auto-ranging is convenient because the multimeter automatically selects an appropriate range for sensing and displaying each measurement. However, manual ranging results in better performance, because the multimeter does not have to determine which range to use for each measurement.

**NOTE**

The range is fixed for diode tests, temperature, and  $Z_{LOW}$  measurements.

In auto-range, the multimeter selects the lowest range to display the highest available precision (resolution) for the input signal. If manual range is already enabled, press  for more than 1 second to enter the auto-ranging mode.

If auto-ranging is enabled, press  to enter the manual range mode.

Each additional press of  sets the multimeter to the next higher range, unless it is already in the highest range, at which point the range switches to the lowest range.

## Alerts and warnings during measurement

### Voltage alert

**WARNING**

For your own safety, please do not ignore the voltage alert. When the multimeter cautions you with a voltage alert, you are advised to take note of the high voltage existence and to use precautions when performing measurements.

Your multimeter provides a voltage alert for voltage measurements in both auto-ranging and manual range modes. The multimeter starts beeping periodically once the measured voltage exceeds the alert value (regardless of polarity) set in the setup menu.

By default, this feature is turned off. Be sure to set the alert voltage according to your test requirements. To change the alert voltage level, refer to [“Enabling the overvoltage alert”](#) on page 143.

### Hazardous voltage indication

The multimeter will also display the hazardous voltage  symbol as an early precaution when the measured voltage is equal to or greater than 30 V in all voltage measurement modes.

## Input warning

### CAUTION

To avoid circuit damage and possibly blowing the multimeter's current fuse, do not place the probes across (in parallel with) a powered circuit when a lead is plugged into a current terminal. This causes a short circuit because the resistance through the multimeter's current terminals is very low.

The multimeter emits a continuous beep and displays **Error ON A INPUT** or **Error ON mA INPUT** when the test lead is inserted into the  $\mu\text{A}$  mA or A input terminal but the rotary switch is not set to the correct current position.



Figure 1-3 Input warning display (A INPUT)

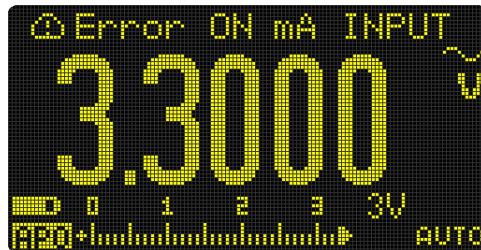
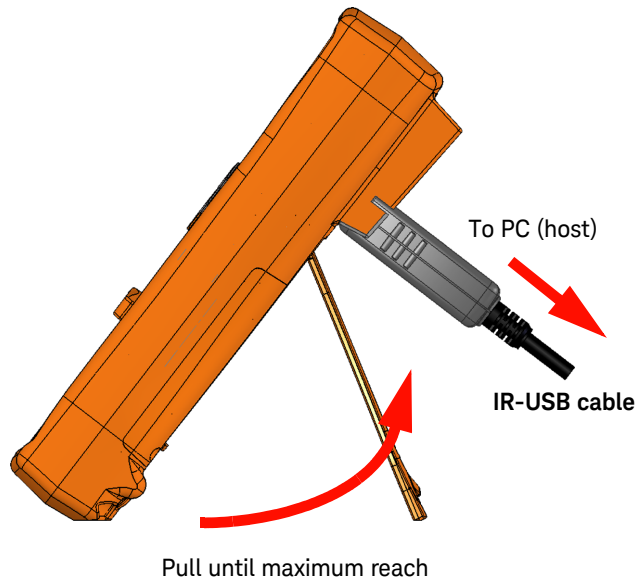

Figure 1-4 Input warning display (mA INPUT)

This warning is intended to stop you from attempting to measure voltage, continuity, resistance, capacitance, diode, or temperature values when the leads are plugged into a current terminal.

## Adjust the tilt stand

To adjust the multimeter to a 60° standing position, pull the tilt-stand outward to its maximum reach.



**Figure 1-5** Tilt-stand adjustment and IR-USB cable connection

## Connect the IR-USB cable

You can use the IR communication link (IR communication port, located at the rear panel) and the Keysight GUI Data Logger software to control your multimeter remotely, perform data logging operations, and transfer the contents of your multimeter's memory to a PC.

Ensure that the Keysight logo on the U1173A IR-USB cable (purchased separately) connected to the multimeter is facing up. Firmly push the IR head into the multimeter's IR communication port until it snaps into place (see [Figure 1-5](#)).

Refer to the *Keysight GUI Data Logger Software Help* and *Quick Start Guide* for more information on the IR communication link and the Keysight GUI Data Logger software.



**Figure 1-6** Keysight GUI Data Logger Software







The Keysight GUI Data Logger software and its supporting documents (Help and Quick Start Guide) are available for free download at <http://www.keysight.com/find/hhTechLib>.

You may purchase a U1173A IR-USB cable from a Keysight Sales Office nearest to you.

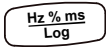
## Power-on options

Some options can be selected only while you turn the multimeter on. These power-on options are listed in the table below. To select a power-on option, press and hold the specified key while turning the rotary switch to any other position (OFF to ON). Power-on options remain selected until the multimeter is turned off.

**Table 1-1** Power-on options

Key	Description
	Checks firmware version. The multimeter's firmware version will be shown on the primary display. Press any key to exit this mode.
	Simulates the Auto Power-Off (APO) mode. Press any key to turn the multimeter back on and resume normal operation.
	Displays the factory default power-on greeting. Press any key to exit this mode.
	Auto Power-Off (APO) is disabled until the multimeter is turned off. To permanently disable APO, see <a href="#">"Changing the auto power-off (APO) timer"</a> on page 138.
	Displays the user-defined power-on greeting. Press any key to exit this mode.
	Tests the OLED. All OLED pixels are lighted. Use this mode to verify that there are no dead OLED pixels. Press any key to exit this mode.
	Smooth is enabled until the multimeter is turned off. To permanently enable Smooth, see <a href="#">"Enabling smooth mode"</a> on page 144.



# Your Multimeter in Brief

## Dimensions

Front view



**Figure 1-7** Width dimensions

Rear and side view

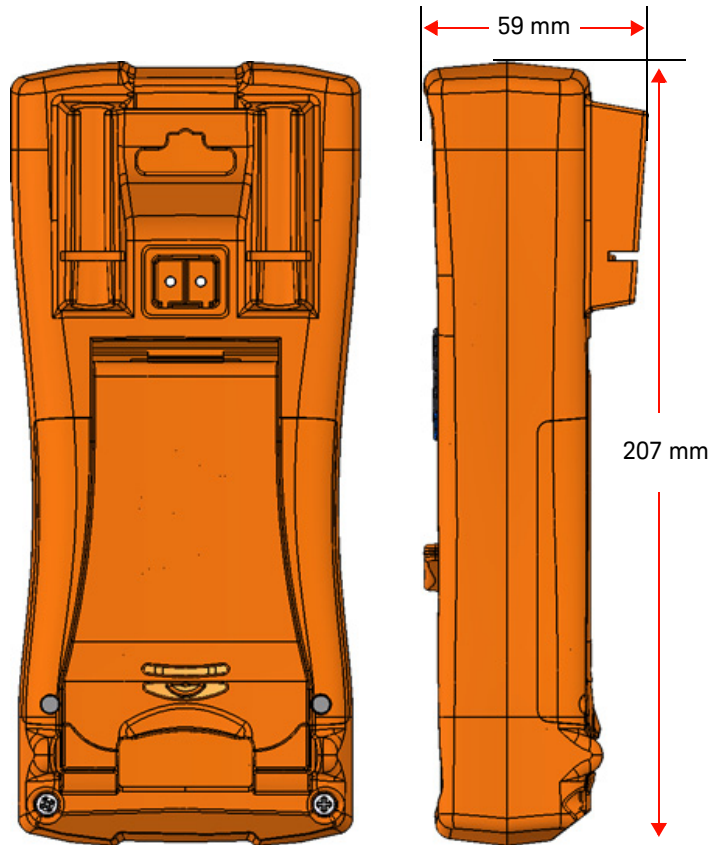

**Figure 1-8** Height and depth dimensions

## Overview

### Front panel

The front panel parts of your multimeter are described in this section. Click the respective “Learn more” pages for more information on each part.



**Figure 1-9** Front panel

**Table 1-2** Front panel parts

Legend	Description	Learn more on:
1	Display screen	<a href="#">page 44</a>
2	Keypad	<a href="#">page 39</a>
3	Rotary switch	<a href="#">page 37</a>
4	Terminals	<a href="#">page 50</a>

## Rear panel

The rear panel parts of your multimeter are described in this section. Click the respective “Learn more” pages for more information on each part.

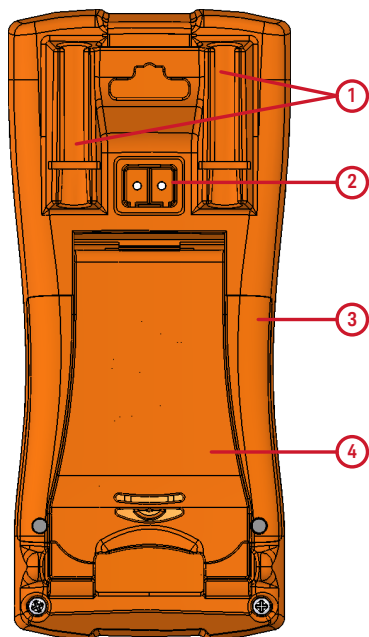

**Figure 1-10** Rear panel

**Table 1-3** Rear panel parts



Legend	Description	Learn more on:
1	Test probe holders	-
2	IR communication port	<a href="#">page 30</a>
3	Battery and fuse access cover	<a href="#">page 23</a>
4	Tilt stand	<a href="#">page 30</a>

## Rotary switch

The measurement functions for each rotary switch position are described in [Table 1-4](#). Turning the rotary switch changes the measurement function and resets all other measurement options.

Click the respective “Learn more” pages for more information on each function.

### NOTE

Some rotary switch positions have a *shifted* function printed in **orange**. Press  to switch between the shifted and default function. See [page 43](#) for more information on the  key.

### WARNING



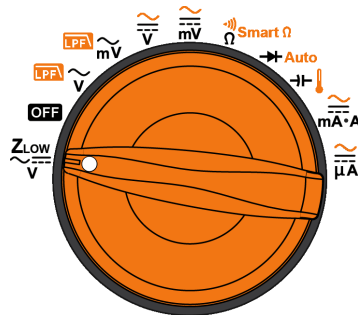







Remove the test leads from the measuring source or target before changing the rotary switch position.



**Figure 1-11** U1273A/U1273AX rotary switch

Each position of the U1273A/U1273AX rotary switch (shown in [Figure 1-11](#)) is described in [Table 1-4](#).

**Table 1-4** U1273A/U1273AX rotary switch functions

Legend	Description	Learn more on:
	Low impedance AC or DC voltage measurement for eliminating ghost voltages	<a href="#">page 67</a>
	Off	<a href="#">page 26</a>
	AC voltage measurement with Low Pass Filter	<a href="#">page 54</a> and <a href="#">page 57</a>
	AC voltage measurement (up to millivolts) with Low Pass Filter	
	AC, DC, or AC+DC voltage measurement	<a href="#">page 54</a> , <a href="#">page 58</a> , and <a href="#">page 61</a>
	AC, DC, or AC+DC voltage measurement (up to millivolts)	
	Resistance measurement, Continuity test, or Resistance measurement with offset compensation	<a href="#">page 69</a> , <a href="#">page 73</a> , and <a href="#">page 76</a>
	Diode test or Auto-diode test	<a href="#">page 79</a> and <a href="#">page 83</a>
	Capacitance or Temperature measurement	<a href="#">page 85</a> and <a href="#">page 87</a>
	AC, DC, or AC+DC current measurement	<a href="#">page 91</a> and <a href="#">page 61</a>
	AC, DC, or AC+DC current measurement (up to microamperes)	













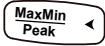

## Keypad

The operation of each key is explained below. Pressing a key enables a function, displays a related symbol, and emits a beep. Turning the rotary switch to another position resets the current operation of the key. Click the respective “Learn more” pages for more information on each function.













**Figure 1-12** Keys

**Table 1-5** Keypad functions









Legend	Function when pressed for:		Learn more on:
	Less than 1 second	More than 1 second	
	<p>Sets the Null/Relative mode.</p> <ul style="list-style-type: none"> <li>The displayed value is saved as a reference to be subtracted from subsequent measurements.</li> <li>While in Null mode, press  again to view the stored reference value that has been saved. The display will return to normal after 3 seconds.</li> <li>Pressing  while the relative value is being displayed will cancel the Null mode.</li> </ul>	<p>Sets the Scale mode for the specified ratio and unit display. (Only applicable for voltage measurements.)</p> <ul style="list-style-type: none"> <li>The most recently saved (or default) ratio and unit will be shown on the primary and secondary displays.</li> <li>Press  while the <b>SCALE</b> symbol is flashing to cycle through the available ratio and unit displays.</li> <li>Press  while the <b>SCALE</b> symbol is flashing to save the selected ratio and unit and to start the conversion, or</li> <li>While the <b>SCALE</b> symbol is flashing, if no activity is detected after 3 seconds, the conversion will begin (with the specified ratio and unit shown on the primary display).</li> <li>Press  for more than 1 second to cancel the Scale transfer mode.</li> </ul>	<p>page 106 and page 108</p>
	<p>Starts the MaxMin recording.</p> <ul style="list-style-type: none"> <li>Press  again to cycle through maximum (<b>REC MAX</b>), minimum (<b>REC MIN</b>), average (<b>REC AVG</b>), and present (<b>REC NOW</b>) readings.</li> <li>Press  for more than 1 second to exit this mode.</li> </ul>	<p>Starts and stops the Peak recording.</p> <ul style="list-style-type: none"> <li>Press  again to switch between the maximum (<b>P-HOLD+</b>) and minimum (<b>P-HOLD-</b>) peak readings.</li> <li>Press  for more than 1 second to exit this mode.</li> </ul>	<p>page 110 and page 112</p>
	<p>Freezes the present reading in the display (<b>T-HOLD</b> mode).</p> <ul style="list-style-type: none"> <li>In TrigHold mode, press  to manually trigger the holding of the next measured value.</li> <li>Press  for more than 1 second to exit this mode.</li> </ul>	<p>Automatically freezes the present reading once the reading is stable (<b>A-HOLD</b> mode)</p> <ul style="list-style-type: none"> <li>In AutoHold mode, the reading is updated automatically once the reading is stable and the count setting is exceeded.</li> <li>Press  for more than 1 second to exit this mode.</li> </ul>	<p>page 114</p>

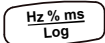













**Table 1-5** Keypad functions (continued)

Legend	Function when pressed for:		Learn more on:
	Less than 1 second	More than 1 second	
	Switches between the dual-combination displays (if available).	Exits the Hold, Null, MaxMin, Peak, frequency test, and dual display modes.	<a href="#">page 155</a>
	Changes the OLED brightness when <b>LOW</b> , <b>MEDIUM</b> , or <b>HIGH</b> setting is selected in the multimeter's setup.	<p>Enters or exits the setup menu.</p> <ul style="list-style-type: none"> <li>- In the setup menu, press  or  to navigate through the menu pages. Press  or  at each menu page to move the cursor to a specific menu item.</li> <li>- Press  to edit the selected menu item. The menu item's value will flash to indicate that you can now change the value shown. Use the arrow keys to change the values shown.</li> <li>- Press  to save the new settings or values and exit the editing mode, or press  to exit the editing mode without saving.</li> <li>- Press  for more than 1 second to exit this mode.</li> </ul>	<a href="#">page 27</a> and <a href="#">page 123</a>

**Table 1-5** Keypad functions (continued)

Legend	Function when pressed for:		Learn more on:
	Less than 1 second	More than 1 second	
 <p>Measures the frequency for the current or voltage measurement.</p> <ul style="list-style-type: none"> <li>– Press  to scroll through the frequency (<b>Hz</b>), pulse width (<b>ms</b>), and duty cycle (<b>%</b>) measurements.</li> <li>– In duty cycle and pulse width measurements, press  to switch between the positive or negative edge trigger.</li> <li>– Press  for more than 1 second to exit this mode.</li> </ul>	<p>Starts and stops the Data Logging.</p> <ul style="list-style-type: none"> <li>– If data logging is set as <b>HAND</b> (manual data logging), pressing  for more than 1 second will log the present reading into the memory. The display will return to normal after a short while (<math>\approx</math> 1 second). To manually log another reading, press  again for more than 1 second.</li> <li>– If data logging is set as <b>AUTO</b> (automatic data logging), pressing  for more than 1 second will enter the automatic data logging mode, where data is logged at the interval defined in the multimeter’s setup.</li> <li>– If data logging is set as <b>TRIG</b> (event data logging), pressing  for more than 1 second will enter the event data logging mode, where data is logged each time a triggering condition is satisfied.</li> <li>– Press  for more than 1 second to exit the automatic or event data logging mode.</li> </ul>	<p>page 100 and page 91</p>	

**Table 1-5** Keypad functions (continued)

Legend	Function when pressed for:		Learn more on:
	Less than 1 second	More than 1 second	
	<ul style="list-style-type: none"> <li>– Sets a manual range and disables auto-ranging. Press  again to cycle through each available measurement range.</li> <li>– During temperature measurements, if Celsius-Fahrenheit (<b>°C-°F</b>) or Fahrenheit-Celsius (<b>°F-°C</b>) is selected as the default temperature unit, pressing  changes the temperature measurement unit between Celsius (°C) and Fahrenheit (°F). See “<a href="#">Changing the temperature unit</a>” on page 135 for more information.</li> </ul>	Enables auto-ranging.	<a href="#">page 27</a> and <a href="#">page 135</a>
	<p>Switches between the default and <i>shifted</i> measurement function (icon printed in <b>orange</b> above the rotary switch position – if available). Press  again to switch back to the default measurement function.</p>	<p>Enters the Log Review menu.</p> <ul style="list-style-type: none"> <li>– Press  again to cycle through the previously recorded manual (<b>VIEW H</b>), interval (<b>VIEW A</b>), or event (<b>VIEW E</b>) logging data.</li> <li>– Press  or  to view first or last logged data respectively. Press  or  to scroll through the logged data.</li> <li>– Press  for more than 1 second to clear all the logged data for the selected logging mode.</li> <li>– Press  for more than 1 second to exit this mode.</li> </ul>	<a href="#">page 37</a> and <a href="#">page 120</a>

## Display screen

The display annunciators of your multimeter are described in this section. See also “[Measurement units](#)” on page 48 for a list of available measurement signs and notations and “[Analog bar graph](#)” on page 49 for a tutorial on the analog bar graph located at the bottom of your display screen.

### General display annunciators

The general display annunciators of your multimeter are described in the table below. Click the respective “Learn more” pages for more information on each annunciator.

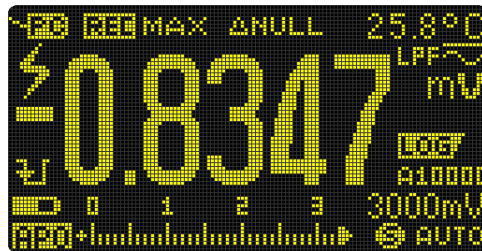

Figure 1-13 Display screen example (single display)

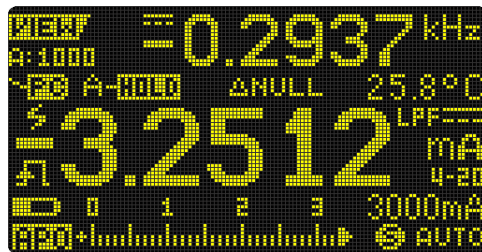































Figure 1-14 Display screen example (dual display)













**Table 1-6** General annunciators

Legend	Description	Learn more on:
	Remote control enabled	<a href="#">page 30</a>
	Bias voltage or leakage current indication for Smart $\Omega$ measurements	<a href="#">page 76</a>
	Data logging in progress	<a href="#">page 115</a>
	Scale transfer enabled	<a href="#">page 108</a>
	View mode for reviewing previously logged data	<a href="#">page 120</a>
	Secondary measurement display	-
	AC, DC, and AC+DC indication for secondary display	<a href="#">page 64</a> , <a href="#">page 67</a> , and <a href="#">page 100</a>
	Elapsed time for Peak and Recording mode	<a href="#">page 112</a> and <a href="#">page 115</a>
	Low-pass filter enabled for AC measurement Filter enabled for DC measurement	<a href="#">page 57</a> <a href="#">page 61</a>
	Hazardous voltage sign for measuring voltage $\geq 30$ V or overload	<a href="#">page 28</a>
	Trigger hold enabled	<a href="#">page 114</a>
	Auto hold enabled	
	Peak hold (maximum value) enabled	<a href="#">page 112</a>
	Peak hold (minimum value) enabled	

**Table 1-6** General annunciators (continued)

Legend	Description	Learn more on:
	Maximum reading shown on primary display	
	Minimum reading shown on primary display	page 110
	Averaged reading shown on primary display	
	Present reading shown on primary display	
	Relative (Null) enabled	page 106
	Relative value when Null is enabled	page 106
	Audible continuity test selected	page 73
	Normal open continuity indication	page 73
	Normal close continuity indication	page 73
	J-type thermocouple selected	page 88
	K-type thermocouple selected	
	Temperature measurement without ambient compensation selected	page 90
	4-20 mA % scale mode selected	page 97
	0-20 mA % scale mode selected	
	DC (direct current)	page 58 and page 91
	AC (alternating current)	page 54 and page 91

**Table 1-6** General annunciators (continued)

Legend	Description	Learn more on:
	AC+DC	<a href="#">page 61</a>
	– Capacitor is charging (during capacitance measurement)	<a href="#">page 58</a> and <a href="#">page 100</a>
	– Positive slope for pulse width ( <b>ms</b> ) and duty cycle ( <b>%</b> ) measurements	
	– Capacitor is discharging (during capacitance measurement)	<a href="#">page 58</a> and <a href="#">page 100</a>
	– Negative slope for pulse width ( <b>ms</b> ) and duty cycle ( <b>%</b> ) measurements	
	Primary measurement display	-
	Battery capacity indication	<a href="#">page 23</a>
	APO (Auto Power-Off) enabled	<a href="#">page 26</a>
	Tone enabled	-
	Analog bar graph	<a href="#">page 49</a>
	Auto-ranging enabled or Auto-diode enabled	<a href="#">page 27</a>
	Diode test selected	<a href="#">page 79</a>
	Smooth mode enabled	<a href="#">page 32</a> and <a href="#">page 144</a>
	Overload (the reading exceeds the display range)	-

## Measurement units

The available signs and notations for each measurement function in your multimeter are described in [Table 1-7](#). The units listed below are applicable to the primary display and secondary display measurements of your multimeter.

**Table 1-7** Measurement units display

Sign/Notation	Description
M	Mega 1E+06 (1000000)
k	kilo 1E+03 (1000)
n	nano 1E-09 (0.000000001)
$\mu$	micro 1E-06 (0.000001)
m	milli 1E-03 (0.001)
dBm	Decibel unit relative to 1 mW
dBV	Decibel unit relative to 1 V
mV, V	Voltage, units for voltage measurement
A, mA, $\mu$ A	Ampere, units for current measurement
nF, $\mu$ F, mF	Farad, units for capacitance measurement
$\Omega$ , k $\Omega$ , M $\Omega$	Ohm, units for resistance measurement
MHz, kHz, Hz	Hertz, units for frequency measurement
ms	Millisecond, unit for pulse width measurement
%	Percent, unit for duty cycle measurement
$^{\circ}$ C	Degree Celsius, unit for temperature measurement
$^{\circ}$ F	Degree Fahrenheit, unit for temperature measurement
s	Seconds, unit for Peak and Recording mode elapsed time



## Analog bar graph



The analog bar emulates the needle on an analog multimeter, without displaying the overshoot. When measuring peak or null adjustments and viewing fast-changing inputs, the bar graph provides a useful indication because it has a faster updating rate<sup>[1]</sup> to cater for fast-response applications.

For frequency, duty cycle, pulse width, 4-20 mA % scale, 0-20 mA % scale, dBm, dBV, and temperature measurements, the bar graph does not represent the primary display value.

For example, when frequency, duty cycle, or pulse width is displayed on the primary display during voltage or current measurement, the bar graph represents the voltage or current value (not the frequency, duty cycle, or pulse width value). Another example is when 4-20 mA % scale or 0-20 mA % scale is displayed on the primary display, the bar graph represents the current value and not the percentage value.

The “+” or “-” sign indicates whether the measured or calculated value is positive or negative. Each segment represents 1000 or 500 counts depending on the range indicated on the peak bar graph.

**Table 1-8** Analog bar graph display

Range	Counts/ Segments	Used for the function
	500	V, A, $\rightarrow$ †
	1000	V, A, $\Omega$ , $\rightarrow$ †

An unstable bar graph and unmatched primary display when measuring DC voltage usually means the presence of AC voltages in the circuit.

[1] The analog bar graph measurement rate is approximately 50 times/second for DC voltage, current, and resistance measurements.



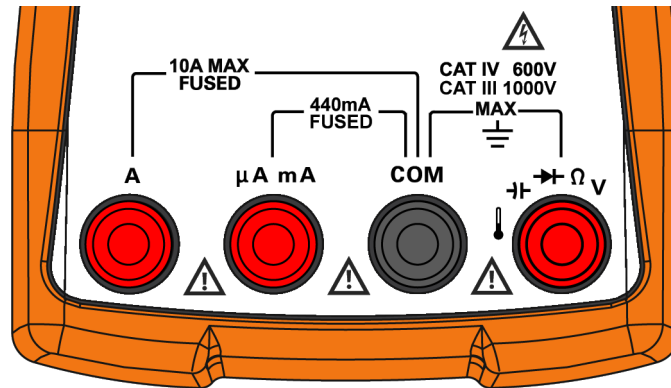

## Input terminals

The terminal connections for the different measurement functions of your multimeter are described in the table below. Observe the rotary switch position of your multimeter before connecting the test leads to the connector terminals.

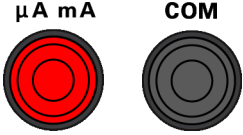

**Figure 1-15** Connector terminals

**Table 1-9** Terminal connections for different measuring functions

Rotary switch position	Input terminals	Overload protection
		1000 VRMS
		
		
		1000 VRMS for short circuit <0.3 A
		
		
		
		
		11 A/1000 V, fast-acting fuse
		440 mA/1000 V, fast-acting fuse
		

## Cleaning Your Multimeter

**WARNING**

To avoid electrical shock or damage to the multimeter, ensure that the insides of the casing stay dry at all times.

---

Dirt or moisture in the terminals can distort readings. Follow the steps below to clean your multimeter.

- 1 Turn the multimeter off, and remove the test leads.
- 2 Turn the multimeter over, and shake out any dirt that may have accumulated in the terminals.

Clean the case with a soft, lint-free, slightly dampened cloth. Do not use detergent, volatile liquids, or chemical solvents.

## 2 Making Measurements

Crest Factor	54
Measuring AC Voltage	55
Measuring DC Voltage	58
Measuring AC and DC Signals	62
Using $Z_{LOW}$ for Voltage Measurements	67
Measuring Resistance	69
Testing for Continuity	73
Using Smart $\Omega$ for Resistance Measurements	76
Testing Diodes	79
Using Auto-diode for Diode Tests	83
Measuring Capacitance	85
Measuring Temperature	87
Measuring AC or DC Current	91
Measuring Frequency	100

The following sections describe how to take measurements with your multimeter.

## Crest Factor

The crest factor may be determined by using this formula:

$$\text{Crest factor} = \frac{\text{Peak value}}{\text{True RMS value}}$$

You may refer to “Capturing Peak Values (Peak)” on page 112 on how to obtain the peak values.

The crest factor may be up to 3.0 at full-scale except for the 1000 V range where it is 1.5 at full scale, as explained in the table below:

Voltage range	Crest factor	Maximum input ( $V_{\text{peak}}$ )
30 mV	3	+/- 90 mV
300 mV	3	+/- 900 mV
3 V	3	+/- 9 V
30 V	3	+/- 90 V
300 V	3	+/- 900 V
1000 V	1.5	+/- 1500 V





### WARNING

Exceeding the crest factor limit may result in an incorrect or a lower reading. Do not exceed the crest factor limit to avoid instrument damage and the risk of electric shock.

## Measuring AC Voltage

Set up your multimeter to measure AC voltage as shown in [Figure 2-2](#). Probe the test points, and read the display.

**Table 2-1** Rotary switch positions allowing AC voltage measurements

Legend	Default function	Function when  is pressed
	AC V	AC V with LPF
	AC mV	AC mV with LPF
	DC V	Cycles between - AC V, - AC+DC V, or - DC V
	DC mV	Cycles between - AC mV, - AC+DC mV, or - DC mV

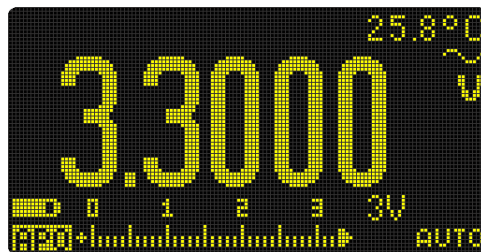

**NOTE**

AC voltage measurements measured with this multimeter are returned as true RMS (root mean square) readings. These readings are accurate for sinusoidal waves and other waveforms with no DC offset, such as square waves, triangle waves, and staircase waves.



**Figure 2-1** AC voltage display

**NOTE**

- For measuring AC voltage signals with DC offset, refer to the [Using the Filter Function for DC measurements](#) section later in this manual.
- Press  to cycle through the available dual display combinations. See [Appendix B, “Dual Display Combinations Using the Dual Key,”](#) starting on page 155 to learn more.
- Press  to measure the frequency of the AC voltage source. See [“Measuring Frequency”](#) on page 100 to learn more.







**Figure 2-2** Measuring AC voltage



## Using the LPF (Low Pass Filter) function for AC measurements

Your multimeter is equipped with an AC low-pass filter to help reduce unwanted electronic noise when measuring AC voltage or AC frequency.

**Table 2-2** Rotary switch positions allowing AC voltage measurements with LPF

Legend	Default function	Function when  is pressed
 	AC V	AC V with LPF
 	AC mV	AC mV with LPF

Set up your multimeter to measure AC voltage as shown in [Figure 2-2](#). Press  to activate the LPF option. Your multimeter continues measuring in the chosen AC mode, but now the signal diverts through a filter that blocks unwanted voltages above 1 kHz. Probe the test points, and read the display.

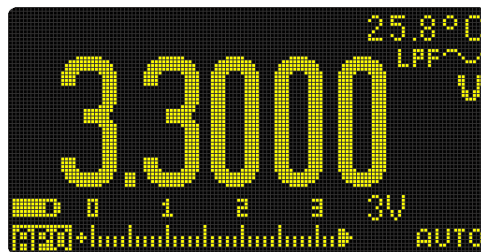

**Figure 2-3** AC voltage with LPF display

### WARNING



- To avoid possible electric shock or personal injury, do not use the Low Pass Filter option to verify the presence of hazardous AC voltages. AC voltage values greater than what are indicated may be present when the Low Pass Filter is enabled.
- First, make an AC voltage measurement with the filter OFF to detect the possible presence of hazardous voltages. Then, select the filter function if required for measurement stability and response speed.

The low-pass filter can improve measurement performance on composite sine waves that are typically generated by inverters and variable frequency motor drives.

## Measuring DC Voltage

Set up your multimeter to measure DC voltage as shown in [Figure 2-5](#). Probe the test points, and read the display.

**Table 2-3** Rotary switch positions allowing DC voltage measurements

Legend	Default function	Function when  is pressed
	DC V	Cycles between - AC V, - AC+DC V, or - DC V
	DC mV	Cycles between - AC mV, - AC+DC mV, or - DC mV

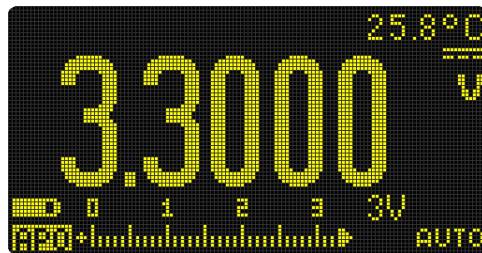

**NOTE**

This multimeter displays DC voltage values as well as their polarity. Negative DC voltages will return a negative sign on the left of the display.



**Figure 2-4** DC voltage display

**NOTE**

- For firmware version 1.64 and below, the Filter function is switched off by default. Customers are advised to update their products to the latest firmware version to take advantage of the latest safety features and measurement improvements.
  - Press  to cycle through the available dual display combinations. See [Appendix B, “Dual Display Combinations Using the Dual Key,”](#) starting on page 155 to learn more.
  - Press  to measure the frequency of the DC voltage source. See [“Measuring Frequency”](#) on page 100 to learn more.
- 

**CAUTION**

- For measuring AC voltage signals with a DC offset, refer to [“Measuring AC and DC Signals”](#) on page 62.
  - For measuring DC voltage from a mixed signal in DC measurement mode, ensure that the Filter is enabled (Refer to [“Enabling the filter”](#) on page 146).
  - To avoid possible electric shock or personal injury, enable the Filter(LPF) to verify the presence of hazardous DC voltages. Displayed DC voltage values can be influenced by high frequency AC components and must be filtered to assure an accurate reading.
-

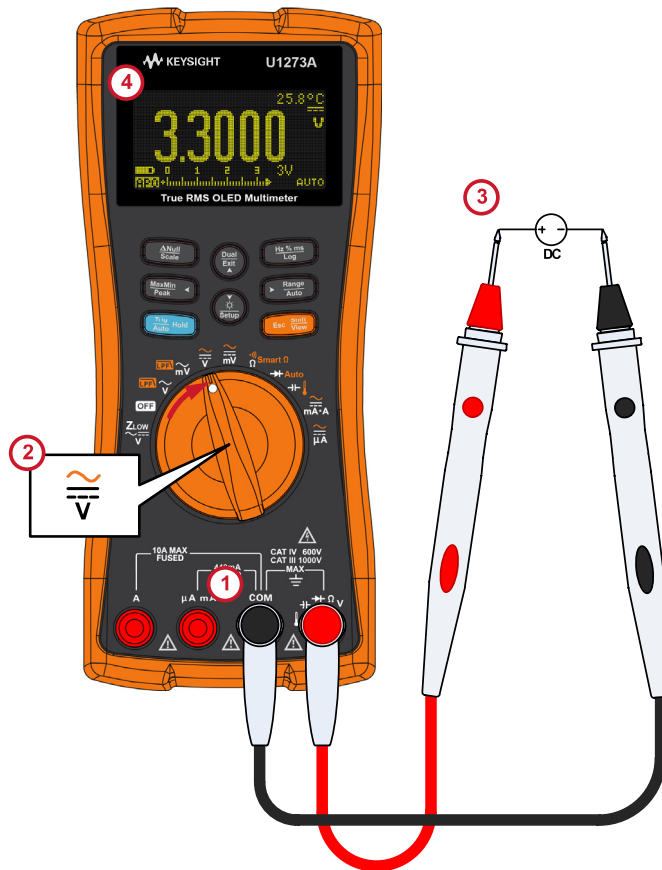

Figure 2-5 Measuring DC voltage

## Using the Filter Function for DC measurements

Turn on the Filter Function when measuring DC voltage and/or current from a mixed signal (AC+DC components) in the DC voltage measurement mode. See “Enabling the filter” on page 146 for more information.

The Filter Function blocks and attenuates AC signals to help you read the DC measurement from a mixed signal. For instance, a DC offset with an AC voltage signal presence (for example, AC 100 V/220 V applied to the 3 V range).

The **LPF** will appear if the Filter is enabled in the multimeter’s Setup.

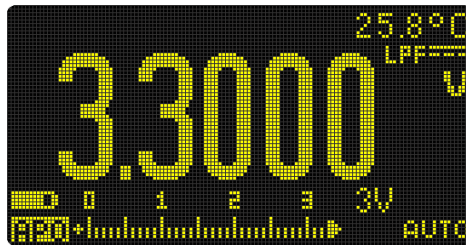

**Figure 2-6** Filter for DC voltage measurements





### WARNING

- To avoid possible electric shock or personal injury, enable the Filter(LPF) to verify the presence of hazardous DC voltages. Displayed DC voltage values can be influenced by high frequency AC components and must be filtered to assure an accurate reading.
- Do not enable any of the dual display options when performing measurements to verify the presence of hazardous DC voltages.

## Measuring AC and DC Signals

Your multimeter is capable of displaying both AC and DC signal components, voltage or current, as two separate readings or one AC+DC (RMS) value combined.

**Table 2-4** Rotary switch positions allowing AC+DC signal measurements

Legend	Default function	Function when  is pressed
	DC V	Cycles between – AC V, – AC+DC V, or – DC V
	DC mV	Cycles between – AC mV, – AC+DC mV, or – DC mV
	DC A (or mA)	Cycles between – AC A (or mA), – AC+DC A (or mA), or – DC A (or mA)
	DC $\mu$ A	Cycles between – AC $\mu$ A, – AC+DC $\mu$ A, or – DC $\mu$ A

Set up your multimeter according to your desired measurement (voltage or current measurement). Press the  key twice to cycle the measurement function to the AC+DC option. Probe the test points, and read the display.

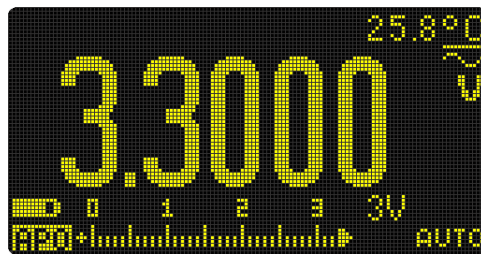

Figure 2-7 AC+DC voltage display

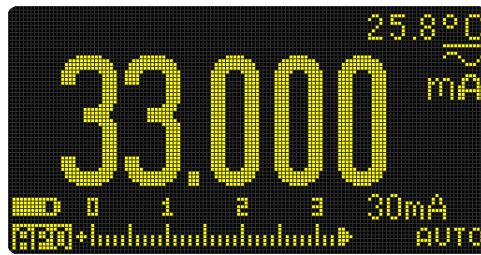







Figure 2-8 AC+DC current display

**NOTE**

- For better accuracy when measuring the DC offset of an AC voltage, measure the AC voltage first. Note the AC voltage range, then manually select a DC voltage range equal to or higher than the AC range. This procedure improves the accuracy of the DC measurement by ensuring that the input protection circuits are not activated.
- Press  to cycle through the available dual display combinations. See [Appendix B, “Dual Display Combinations Using the Dual Key,”](#) starting on page 155 to learn more.
- Press  to measure the frequency of the AC+DC voltage source. See [“Measuring Frequency”](#) on page 100 to learn more.

## Using the LPF (Low Pass Filter) Function for AC+DC measurements

Your multimeter is equipped with an AC low pass filter to help reduce unwanted electronic noise when measuring a mixed signal.

- 1 Enable the LPF (You may refer to “Enabling the filter” on page 146)
- 2 Rotate the multimeter’s rotary switch to  / .
- 3 Press  to activate the low pass filter function (). Your multimeter continues measuring in the AC+DC mode, but now the signal diverts through a filter that blocks unwanted voltages above 1 kHz

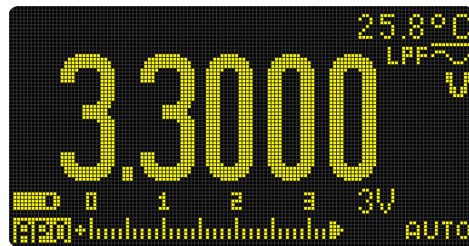

**Figure 2-9** Low Pass Filter(LPF) for AC+DC voltage measurements

## Making dB Measurements





Your multimeter is capable of displaying voltage as a dB value, either relative to 1 milliwatt (dBm) or a reference voltage of 1 volt (dBV).

### Displaying dBm values

To set the multimeter to display voltage values in dBm, first set up your multimeter to measure voltage as shown in [Figure 2-2](#) or [Figure 2-5](#). Probe the test points, and read the display. Then, press  until the voltage measurements are displayed as a dBm value.

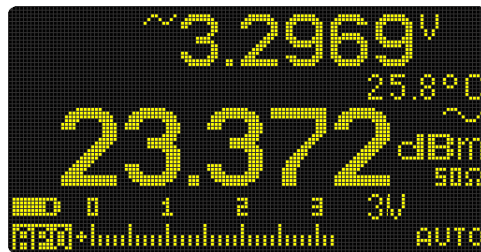

**Table 2-5** Rotary switch positions allowing dBm measurements

Legend	Default function	Function when  is pressed
	AC V	AC V with LPF
	AC mV	AC mV with LPF
	DC V	Cycles between – AC V, – AC+DC V, or – DC V
	DC mV	Cycles between – AC mV, – AC+DC mV, or – DC mV

**NOTE**

A dBm measurement must use a reference impedance (resistance) to calculate a dB value based on 1 milliwatt. The reference impedance is set to 50 Ω by default. To select another reference value, see the **“Changing the custom dBm reference impedance”** on page 134.



**Figure 2-10** dBm display

Press  for more than 1 second to exit the dBm function.

### Displaying dBV values





To set the multimeter to display voltage values in dBV, first change the **dB** (decibel) display from **dBm** to **dBV** in the setup menu. See “[Changing the decibel display](#)” on page 133 to learn more.

#### NOTE

This change is permanent. To set the multimeter to display voltage values in dBm again, you will need to change the **dB** display from **dBV** back to **dBm** in the setup menu.

Next, set up your multimeter to measure voltage as shown in [Figure 2-2](#) or [Figure 2-5](#). Probe the test points, and read the display. Then, press  until the voltage measurements are displayed as a dBV value.

**Table 2-6** Rotary switch positions allowing dBV measurements

Legend	Default function	Function when  is pressed
	AC V	AC V with LPF
	AC mV	AC mV with LPF
	DC V	Cycles between <ul style="list-style-type: none"> <li>- AC V,</li> <li>- AC+DC V, or</li> <li>- DC V</li> </ul>
	DC mV	Cycles between <ul style="list-style-type: none"> <li>- AC mV,</li> <li>- AC+DC mV, or</li> <li>- DC mV</li> </ul>

#### NOTE

A dBV measurement uses a 1 volt reference voltage to compare the present measurement against a stored relative value. The difference between the two AC signals is displayed as a dBV value. The reference impedance setting is not part of a dBV measurement.

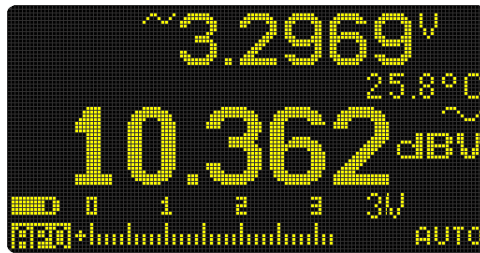

**Figure 2-11** dBV display

Press  for more than 1 second to exit the dBV function.



## Using $Z_{LOW}$ for Voltage Measurements

**CAUTION**

Do not use the  $Z_{LOW}$  function to measure voltages in circuits that could be damaged by this function's low impedance (2 k $\Omega$  (nominal)).

The  $Z_{LOW}$  function in your multimeter presents a low impedance across the leads to obtain a more accurate measurement.

**Table 2-7** Rotary switch positions allowing  $Z_{LOW}$  measurements

Legend	Default function	Function when  is pressed
	$Z_{LOW}$ (AC/DC) V	-

To set up your multimeter to make a  $Z_{LOW}$  (low input impedance) voltage measurement, first set up your multimeter to measure voltage as shown in [Figure 2-2](#) or [Figure 2-5](#). Probe the test points, and read the display.

**NOTE**

The AC voltage measurement is shown in the primary display and the DC voltage measurement is shown in the secondary display. Press  to exchange the AC and DC voltage indication on the primary and secondary displays.

**NOTE**

**Use the  $Z_{LOW}$  (low input impedance) function to remove ghost or induced voltages from your measurements**

Ghost voltages are voltages present on a circuit that should not be energized. Ghost voltages can be caused by capacitive coupling between energized wiring and adjacent unused wiring. The  $Z_{LOW}$  function can remove ghost voltages from your measurements by dissipating the coupling voltage. Use the  $Z_{LOW}$  function to reduce the possibility of false readings in areas where the presence of ghost voltages are suspected.

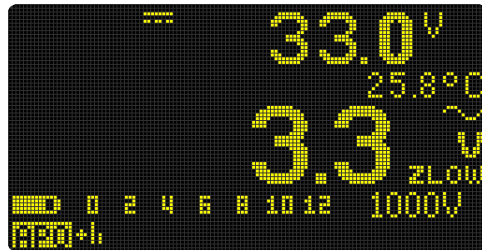

**Figure 2-12**  $Z_{LOW}$  display

**NOTE**

During  $Z_{LOW}$  measurements, autoranging is disabled and the multimeter's range is set to 1000 V in the manual ranging mode. The analog bar graph represents the AC+DC voltage value combined.

### Use Z<sub>LOW</sub> to test a battery's health

Aside from reading a battery's voltage level using the DC voltage measurement function, you can also use the Z<sub>LOW</sub> function to test a battery's health.

If you detect that the measured battery's voltage shown in the Z<sub>LOW</sub> function is declining gradually, this means that the capacity of the battery-under-test is not enough to support regular functions. Use this simple and quick test to determine if a battery has enough voltage capacity to support regular activities.



**NOTE**

Prolonged used of the Z<sub>LOW</sub> function will consume the capacity of the battery-under-test.

## Measuring Resistance

Set up your multimeter to measure resistance as shown in [Figure 2-14](#). Probe the test points, and read the display.

**Table 2-8** Rotary switch position allowing resistance measurements

Legend	Default function	Function when  is pressed
	Resistance measurement (Ω)	Cycles between <ul style="list-style-type: none"> <li>- Continuity test ()</li> <li>- Smart Ω measurement, or</li> <li>- Resistance measurement (Ω)</li> </ul>

**CAUTION**

To avoid possible damage to your multimeter or to the equipment under test, disconnect the circuit power and discharge all high-voltage capacitors before measuring resistance.

**NOTE**

Resistance (opposition to the current flow) is measured by sending a small current out through the test leads to the circuit under test. Because this current flows through all possible paths between the leads, the resistance reading represents the total resistance of all paths between the leads. Resistance is measured in ohms ( $\Omega$ ).

---

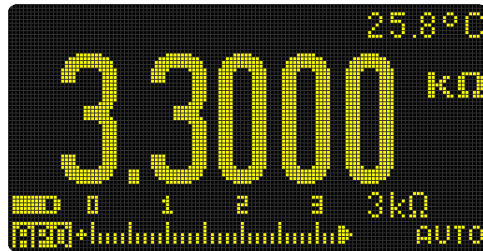

**Figure 2-13** Resistance display

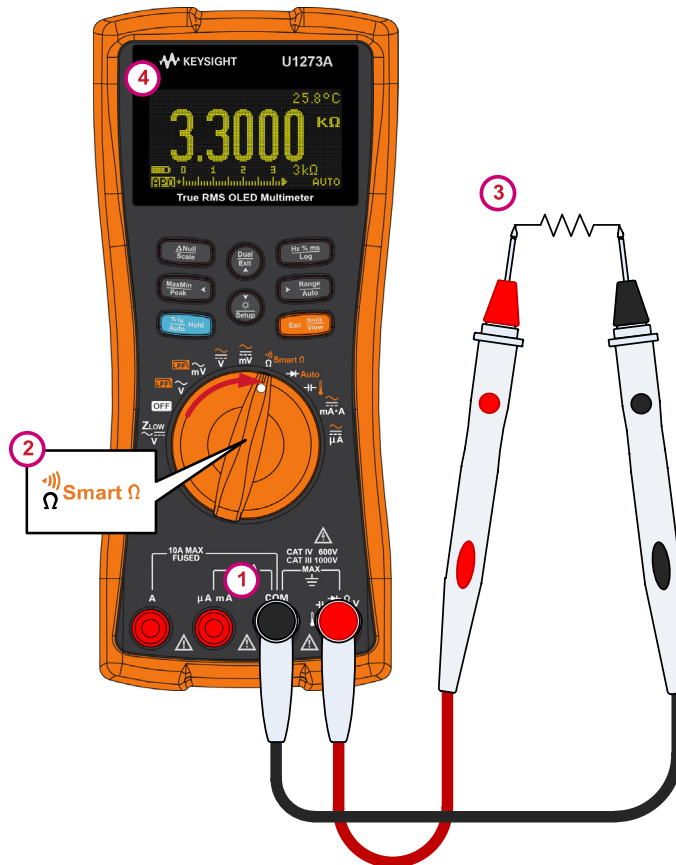



Figure 2-14 Measuring resistance

**NOTE**

Keep the following in mind when measuring resistance.

- The test leads can add 0.1  $\Omega$  to 0.2  $\Omega$  of error to resistance measurements. To test the leads, touch the probe tips together and read the resistance of the leads. To remove lead resistance from the measurement, hold the test lead tips together and press . Now the resistance at the probe tips will be subtracted from all future display readings.
- Because the multimeter's test current flows through all possible paths between the probe tips, the measured value of a resistor in a circuit is often different from the resistor's rated value.
- The resistance function can produce enough voltage to forward-bias silicon diode or transistor junctions, causing them to conduct. If this is suspected, press  to apply a lower current in the next higher range.

## Measuring conductance

Conductance is the reciprocal of resistance. High values of conductance correspond to low values of resistance. Conductance is measured in Siemens (S). The 300 nS range measures conductance in nano-Siemens (1 nS = 0.00000001 Siemens). Because small conductance values correspond to extremely high resistance values, the nS range allows you to easily calculate and determine the resistance of components up to 100 G $\Omega$  (0.01 nS resolution)

To measure conductance, set up your multimeter to measure resistance as shown in [Figure 2-14](#). Press  until the conductance measurement is selected (nS unit shown). Probe the test points, and read the display.



High-resistance readings are susceptible to electrical noise. Use averaging to smooth out most of the noisy readings. Refer to [“Capturing Maximum and Minimum Values \(MaxMin\)”](#) on page 110.



## Testing for Continuity

Set up your multimeter to test for continuity as shown in [Figure 2-16](#). Probe the test points, and read the display.

**Table 2-9** Rotary switch position allowing continuity tests

Legend	Default function	Function when  is pressed
 Smart $\Omega$	Resistance measurement ( $\Omega$ )	Cycles between <ul style="list-style-type: none"> <li>- Continuity test ()</li> <li>- Smart <math>\Omega</math> measurement, or</li> <li>- Resistance measurement (<math>\Omega</math>)</li> </ul>

**CAUTION**

To avoid possible damage to your multimeter or to the equipment under test, disconnect the circuit power and discharge all high-voltage capacitors before testing for continuity.

**NOTE**

Continuity is the presence of a complete path for current flow. The continuity test features a beeper that sounds as long as a circuit is complete, if normal open is selected (or broken, if normal closed is selected). The audible alert allows you to perform quick continuity tests without having to watch the display.



In continuity, a short means a measured value is less than the threshold resistance values listed in [Table 2-10](#).

**Table 2-10** Threshold resistance values

Measuring range	Threshold resistance
30.000 $\Omega$	$<25 \pm 10 \Omega$
300.00 $\Omega$	$<25 \pm 10 \Omega$
3.0000 k $\Omega$	$<250 \pm 100 \Omega$
30.000 k $\Omega$	$<2.5 \pm 1 \text{ k}\Omega$
300.00 k $\Omega$	$<25 \pm 10 \text{ k}\Omega$

**Table 2-10** Threshold resistance values (continued)

Measuring range	Threshold resistance
3.0000 MΩ	<120 ± 60 kΩ
30.000 MΩ	<120 ± 60 kΩ
300.00 MΩ	<120 ± 60 kΩ

The beeper will sound as a continuity indication. Press  to switch between normal open () and normal close () contacts.

- **Normal open:** Circuit is normally open, the beeper will sound when a short is detected.
- **Normal closed:** Circuit is normally closed, the beeper will sound when an open is detected.

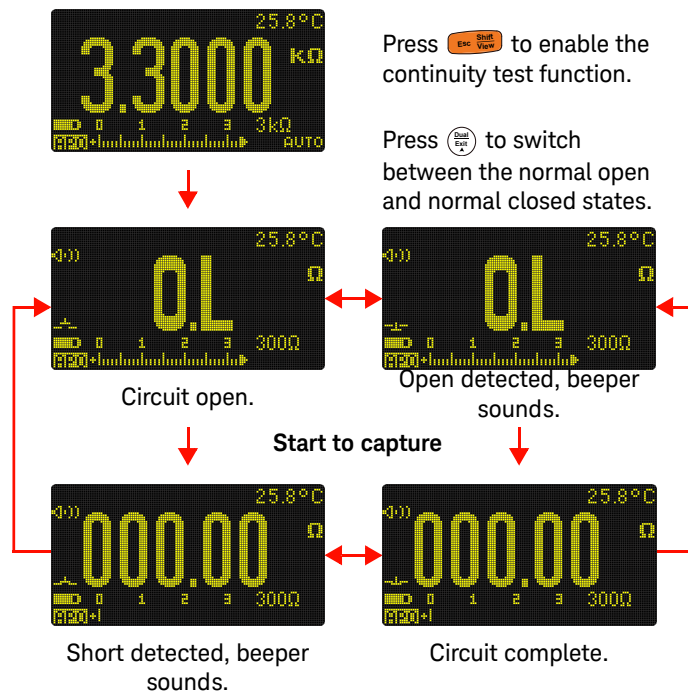

**Figure 2-15** Continuity operation

**NOTE**

- The continuity function detects intermittent shorts and opens lasting as short as 1 ms. A brief short or open causes the multimeter to emit a short beep.
- You can enable or disable the audible alert via the multimeter's setup. See [“Changing the beep frequency”](#) on page 138 for more information on the audible alert option.

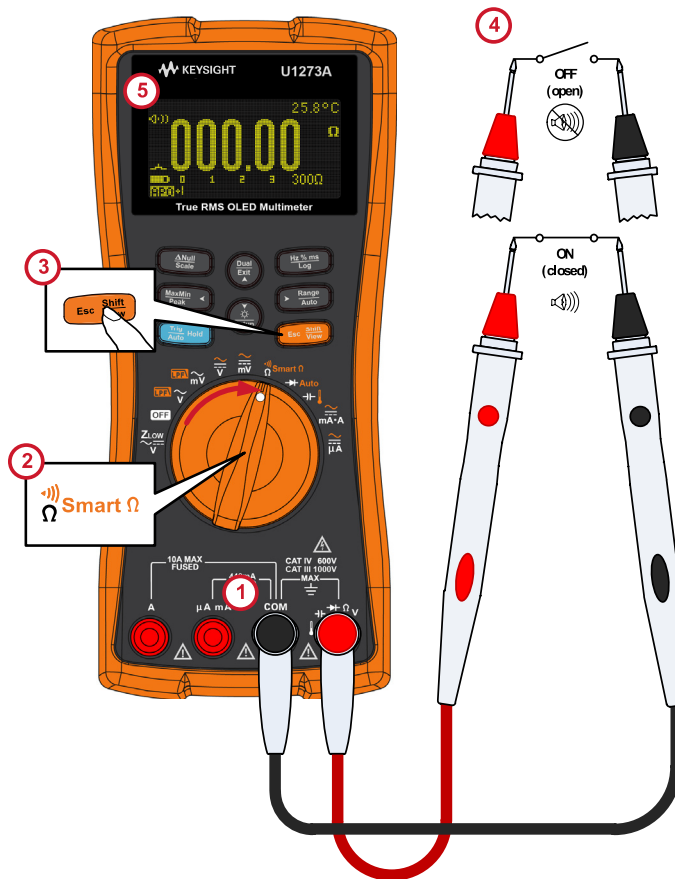



**Figure 2-16** Testing for continuity

## Using Smart $\Omega$ for Resistance Measurements

To use the Smart  $\Omega$  function, set up your multimeter to test for resistance as shown in [Figure 2-17](#). Probe the test points, and read the display.

**Table 2-11** Rotary switch position allowing Smart  $\Omega$  measurements

Legend	Default function	Function when  is pressed
 Smart $\Omega$	Resistance measurement ( $\Omega$ )	Cycles between <ul style="list-style-type: none"> <li>- Continuity test ()</li> <li>- Smart <math>\Omega</math> measurement, or</li> <li>- Resistance measurement (<math>\Omega</math>)</li> </ul>

### NOTE

- Smart  $\Omega$  (offset compensation) removes unexpected DC voltages within the instrument, at the input or at the circuit being measured, which will add to resistance measurement errors. The bias voltage or leakage current is shown on the secondary display.
- Using the offset compensation method, the multimeter takes the difference between two resistance measurements when two different test currents are applied to determine if there are any offset voltages in the input circuitry. The resultant displayed measurement corrects this offset, giving a more accurate resistance measurement.

The resistance measurement and the bias voltage measurement is shown in the primary and secondary displays respectively.

Press  to switch between the leakage current (**LEAK**) or bias voltage (**BIAS**) display.

### NOTE

- The Smart  $\Omega$  is applicable for the 30  $\Omega$ , 300  $\Omega$ , 3 k $\Omega$ , 30 k $\Omega$ , and 300 k $\Omega$  resistance range only. The maximum correctable offset/bias voltage is +50 mV/-30 mV for the 30  $\Omega$  range and +1.0 V/-0.2 V for the 300  $\Omega$ , 3 k $\Omega$ , 30 k $\Omega$ , and 300 k $\Omega$  ranges.
- If the DC voltage on the resistor is over the maximum correctable offset/bias voltage, **OL** is shown on the secondary display.

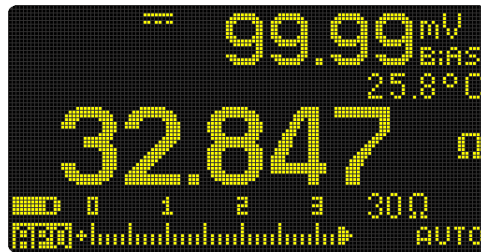

Figure 2-17 Smart  $\Omega$  (with bias voltage) display

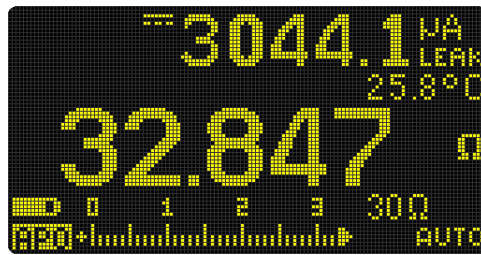

Figure 2-18 Smart  $\Omega$  (with leakage current) display

### Use Smart $\Omega$ to measure the resistance of a thermocouple sensor

It is useful to measure the resistance of a thermocouple temperature sensor. The thermovoltage is proportional to the temperature and the impact of the resistance measurement. Using the Smart  $\Omega$  function will help you achieve precise readings regardless of the temperature.

### Use Smart $\Omega$ to measure leakage current

Use the Smart  $\Omega$  function to measure leakage current or reverse current for junction diodes. Such leakage currents are negligible and are usually measured in units of  $\mu\text{A}$  or  $\text{nA}$ . Instead of having to source a high-precision multimeter with a 1 nA or 0.1 nA accuracy or a precision shunt, you can measure the leakage current using the Smart  $\Omega$  function with just a resistor from 100 k $\Omega$  to 300 k $\Omega$ .

## 2 Making Measurements

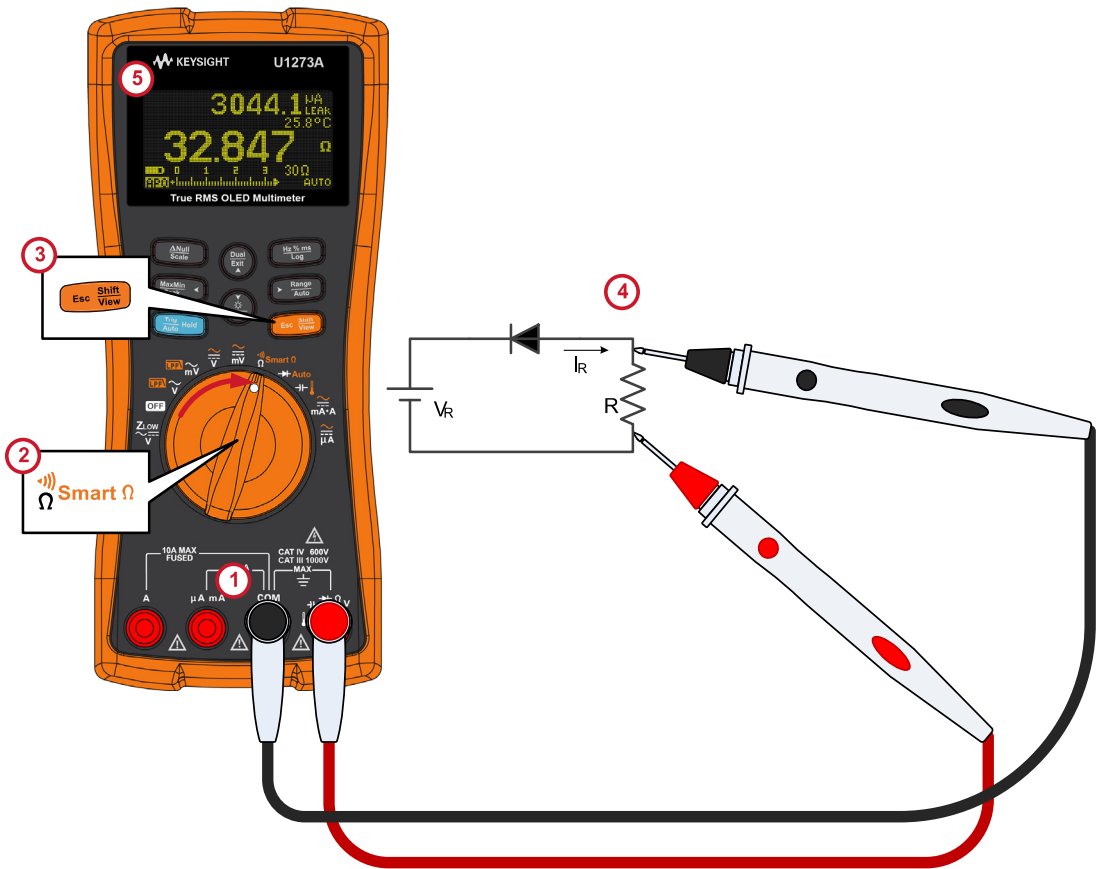



Figure 2-19 Measuring leakage current

## Testing Diodes

Set up your multimeter to test diodes as shown in [Figure 2-22](#). Probe the test points, and read the display.

**Table 2-12** Rotary switch position allowing diode tests

Legend	Default function	Function when  is pressed
 Auto	Diode test	Auto-diode test

### CAUTION

To avoid possible damage to your multimeter or to the equipment under test, disconnect the circuit power and discharge all high-voltage capacitors before testing diodes.

### NOTE

- Use the diode test to check diodes, transistors, silicon controlled rectifiers (SCRs), and other semiconductor devices. A good diode allows current to flow in one direction only.
- This test sends a current through a semiconductor junction, and then measures the junction’s voltage drop. A typical junction drops 0.3 V to 0.8 V.
- Connect the red test lead to the positive terminal (anode) of the diode and the black test lead to the negative terminal (cathode). The cathode of a diode is indicated with a band.

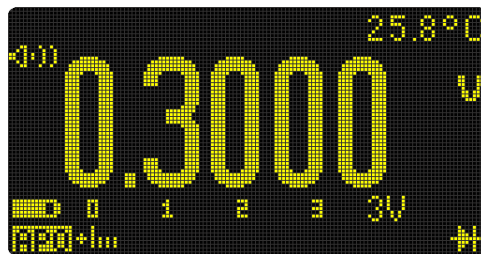

**Figure 2-20** Diode display

**NOTE**

- Your multimeter can display diode forward-bias of up to approximately 3.1 V. The forward-bias of a typical diode is within the range of 0.3 V to 0.8 V; however, the reading can vary depending on the resistance of other pathways between the probe tips.
- If the beeper is enabled during diode test, the multimeter will beep briefly for a normal junction and sound continuously for a shorted junction, below 0.050 V. See “[Changing the beep frequency](#)” on page 138 to disable the beeper.

Reverse the probes (as shown in [Figure 2-23](#)) and measure the voltage across the diode again. Assess the diode according to the following guidelines:

- A diode is considered good if the multimeter displays **OL** in reverse-bias mode.
- A diode is considered shorted if the multimeter displays approximately 0 V in both forward- and reverse-bias modes, and the multimeter beeps continuously.
- A diode is considered open if the multimeter displays **OL** in both forward- and reverse-bias modes.



**Figure 2-21** Open diode display



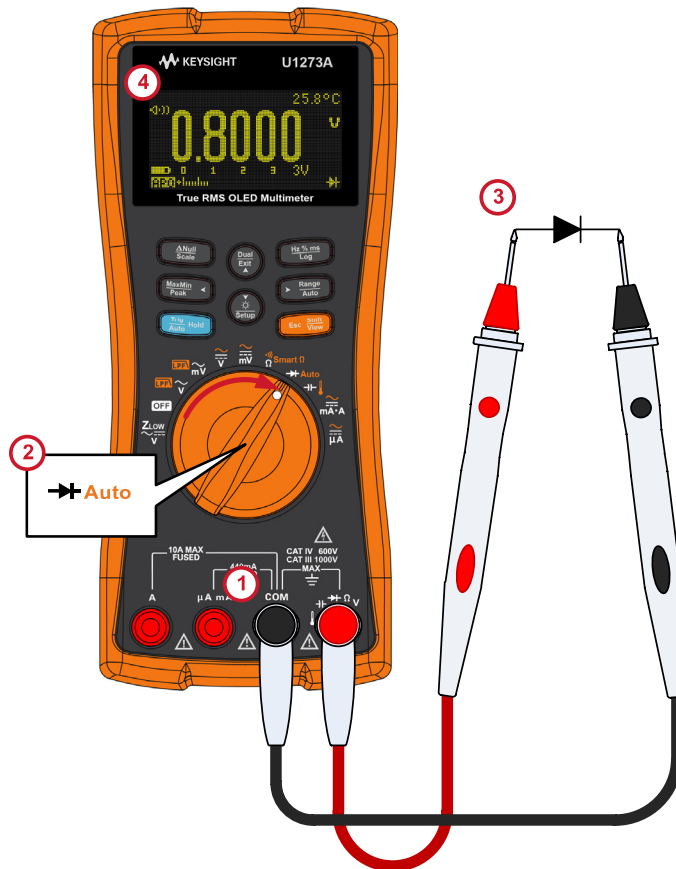

Figure 2-22 Testing a forward-bias diode

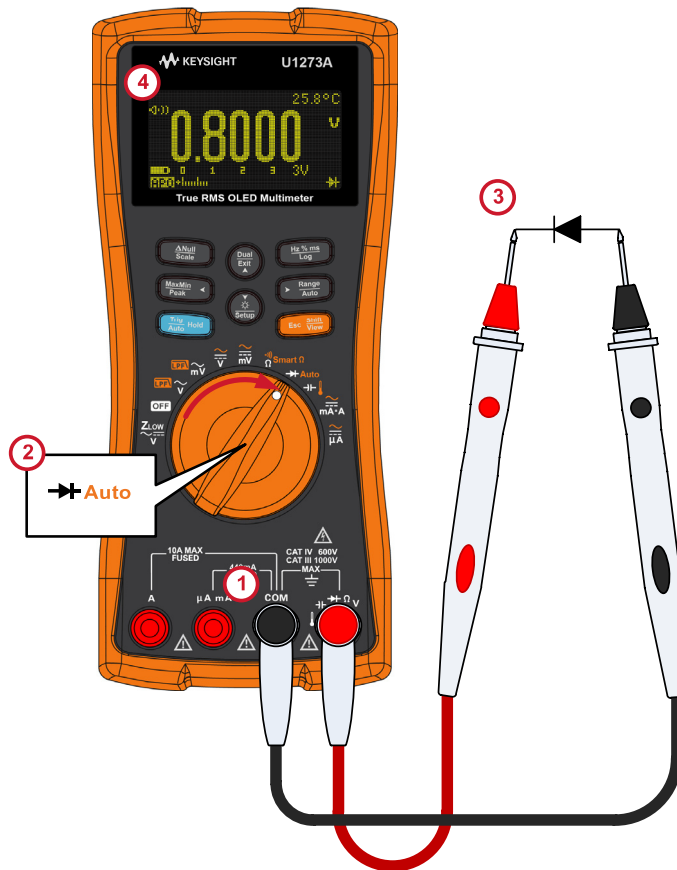



Figure 2-23 Testing a reverse-bias diode

## Using Auto-diode for Diode Tests

Set up your multimeter to test diodes as shown in [Figure 2-22](#). Probe the test points, and read the display.



**Table 2-13** Rotary switch position allowing auto-diode tests

Legend	Default function	Function when  is pressed
 Auto	Diode test	Auto-diode test

### NOTE

The auto-diode function will help you test both forward- and reverse-bias directions simultaneously. You do not need to change the measuring direction to identify the diode's status.

**Table 2-14** Auto-diode voltage thresholds

Forward voltage Primary display	Reverse voltage Secondary display	Diode status	
		Good	No Good
OL or <0.3 V or >0.8 V	-OL or >-0.3 V or <-0.8 V		
Within 0.3 V to 0.8 V	-OL		
OL	Within -0.3 V to -0.8 V		

### NOTE

The open condition will not be alerted as **OL** on both directions if the auto-diode function is used.

The primary display shows the forward-bias voltage value. The reverse-bias voltage value is shown in the secondary display.

- **GOOD** is shown briefly (along with a single beep) on the secondary display if the diode is in a good condition.
- **NGOOD** is shown briefly (along with two beeps) if the diode is out of the thresholds.



Figure 2-24 Auto-diode display (GOOD status)

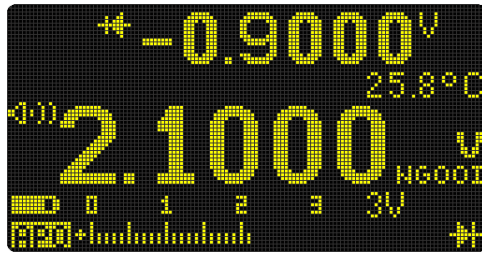



Figure 2-25 Auto-diode display (NGOOD status)

## Measuring Capacitance

Set up your multimeter to measure capacitance as shown in [Figure 2-27](#). Probe the test points, and read the display.



**Table 2-15** Rotary switch position allowing capacitance measurements

Legend	Default function	Function when  is pressed
	Capacitance measurement	Temperature measurement

**CAUTION**

To avoid possible damage to the multimeter or to the equipment under test, disconnect circuit power and discharge all high-voltage capacitors before measuring capacitance. Use the DC voltage function to confirm that the capacitor is fully discharged.

**NOTE**

- The multimeter measures capacitance by charging the capacitor with a known current for a known period of time, measuring the resulting voltage, and then calculating the capacitance.
-  is shown on the bottom left of the display when the capacitor is charging, and  is shown when the capacitor is discharging.

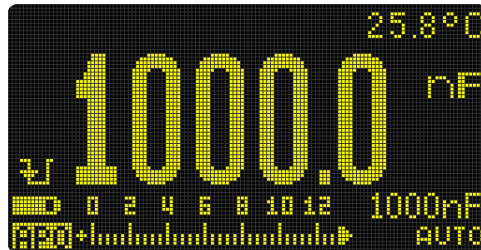

**Figure 2-26** Capacitance display

**NOTE**

To improve measurement accuracy of small value capacitors, press  with the test leads open to subtract the residual capacitance of the multimeter and leads.

**NOTE**

For measuring capacitance values greater than 1000  $\mu\text{F}$ , discharge the capacitor first, then select a suitable range for measurement. This will speed up the measurement time and also ensure that the correct capacitance value is obtained.

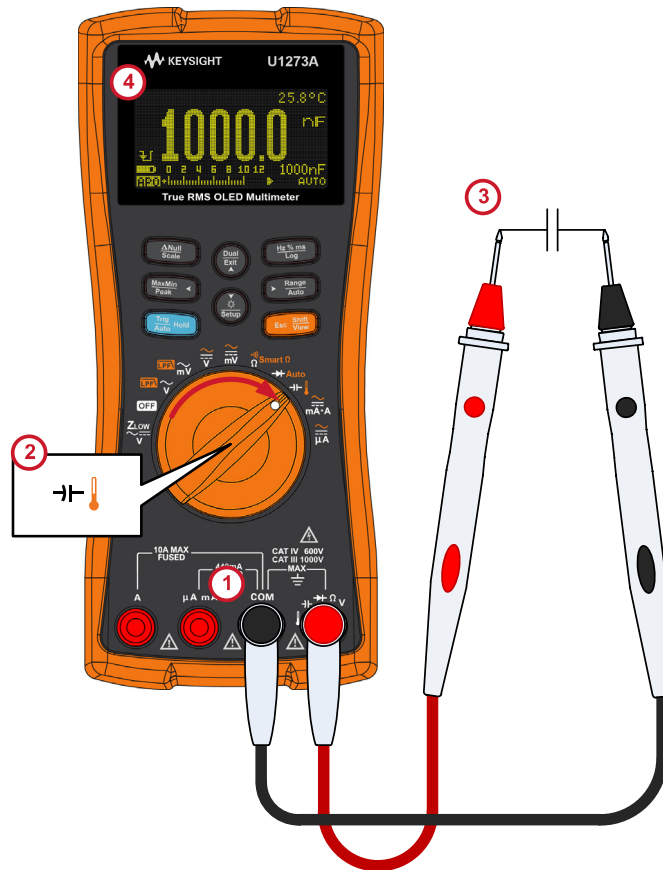

**Figure 2-27** Measuring capacitance

## Measuring Temperature

### WARNING



Do not connect the thermocouple to electrically live circuits. Doing so will potentially cause fire or electric shock.

### CAUTION

Do not bend the thermocouple leads at sharp angles. Repeated bending over a period of time can break the leads.

The multimeter uses a type-K (default setting) temperature probe for measuring temperature. To measure temperature, set up your multimeter as shown in [Figure 2-29](#).

**Table 2-16** Rotary switch position allowing temperature measurements

Legend	Default function	Function when  is pressed
	Capacitance measurement	Temperature measurement

Probe the test points, and read the display. The primary display normally shows temperature or the message **OL** (open thermocouple). The open thermocouple message may be due to a broken (open) probe or because no probe is installed into the input jacks of the multimeter.



**Figure 2-28** Temperature display

Press  to change the temperature units between °C or °F (you must first change the temperature unit to switch between °C and °F or °F and °C). See “Changing the temperature unit” on page 135 for more information.

**CAUTION**

The option to change the temperature unit is locked for certain regions. Always set the temperature unit display per the official requirements and in compliance with the National laws of your region.

---

**NOTE**



- Shorting the  terminal to the **COM** terminal will display the temperature at the multimeter’s terminals.
  - To change the default thermocouple type from type-K to type-J, see “Changing the thermocouple type” on page 135 for more information.
- 

**NOTE**

The bead-type thermocouple probe is suitable for measuring temperatures from –40 °C to 204 °C (399 °F) in PTFE-compatible environments. Do not immerse this thermocouple probe in any liquid. For best results, use a thermocouple probe designed for each specific application – an immersion probe for liquid or gel, and an air probe for air measurement.

Observe the following measurement techniques:

- Clean the surface to be measured, and ensure that the probe is securely touching the surface. Remember to disable the applied power.
- When measuring above ambient temperatures, move the thermocouple along the surface until you get the highest temperature reading.
- When measuring below ambient temperatures, move the thermocouple along the surface until you get the lowest temperature reading.
- Place the multimeter in the operating environment for at least 1 hour as the multimeter is using a non-compensation transfer adapter with miniature thermal probe.

For quick measurement, use the  compensation to view the temperature variation of the thermocouple sensor. The  compensation assists you in measuring relative temperature immediately.

---



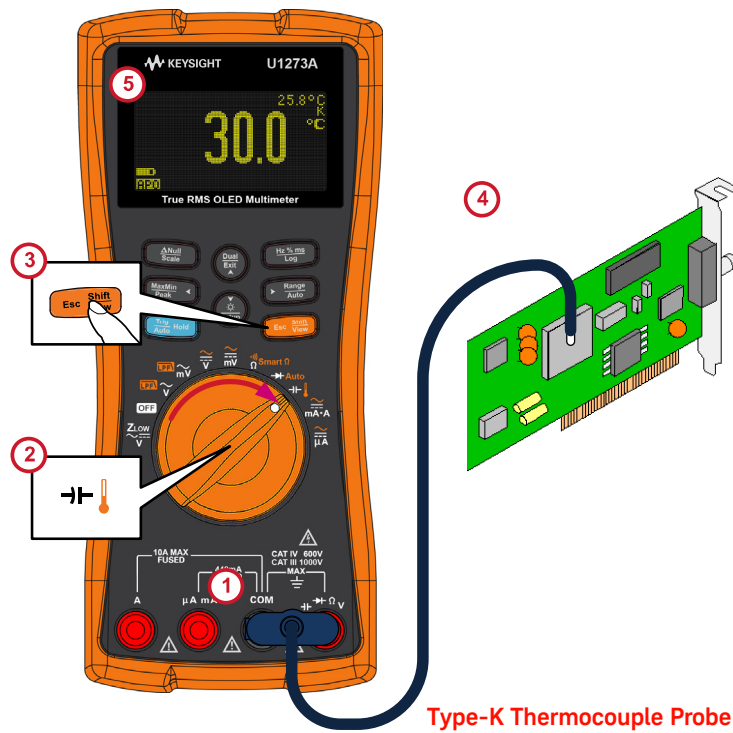



Figure 2-29 Measuring surface temperature

### Temperature measurement without ambient compensation

If you are working in a constantly varying environment, where ambient temperatures are not constant, do the following:

- 1 Press  to select **REL** compensation. This allows a quick measurement of the relative temperature.
- 2 Avoid contact between the thermocouple probe and the surface to be measured.
- 3 After a constant reading is obtained, press  to set the reading as the relative reference temperature.
- 4 Touch the surface to be measured with the thermocouple probe and read the display.





**Figure 2-30** Temperature measurement without ambient compensation

## Measuring AC or DC Current

Set up your multimeter to measure AC or DC current as shown in [Figure 2-32](#) and [Figure 2-33](#). Open the circuit path to be tested. Probe the test points, and read the display.

**Table 2-17** Rotary switch positions allowing current measurements

Legend	Default function	Function when  is pressed
	DC A (or mA)	Cycles between <ul style="list-style-type: none"> <li>- AC A (or mA),</li> <li>- AC+DC A (or mA)</li> <li>- % Scale of 4-20 mA (or 0-20 mA), or</li> <li>- DC A (or mA)</li> </ul>
	DC µA	Cycles between <ul style="list-style-type: none"> <li>- AC µA,</li> <li>- AC+DC µA, or</li> <li>- DC µA</li> </ul>

### WARNING

Never attempt an in-circuit current measurement where the open-circuit potential to earth is greater than 1000 V. Doing so will cause damage to the multimeter and possible electric shock or personal injury.

### CAUTION

To avoid possible damage to the multimeter or to the equipment under test:

- Check the multimeter's fuses before measuring current.
- Use the proper terminals, function, and range for your measurement.
- Never place the probes across (in parallel with) any circuit or component when the leads are plugged into the current terminals.

**NOTE**

- To measure current, you must open the circuit under test, then place the multimeter in series with the circuit.
- Turn off power to the circuit. Discharge all high-voltage capacitors. Insert the black test lead into the **COM** terminal. Insert the red test lead in an input appropriate for the measurement range.
  - If you are using the **A** terminal, set the rotary switch to  $\overline{\text{mA}}\text{A}$ .
  - If you are using the  **$\mu\text{A}$  mA** terminal, set the rotary switch to  $\overline{\mu\text{A}}$  for currents below 5000  $\mu\text{A}$  (5 mA), or  $\overline{\text{mA}}\text{A}$  for currents above 5000  $\mu\text{A}$ .
- Press  to cycle between DC current measurement, AC current measurement, AC+DC current measurement, or % scale current measurements.
- Reversing the leads will produce a negative reading, but it will not damage the multimeter.

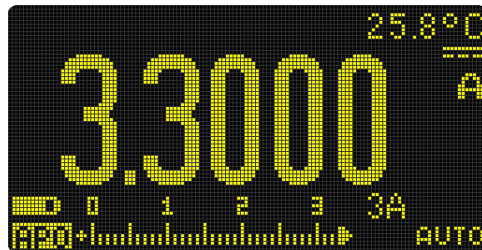

**Figure 2-31** DC current display



**CAUTION**

- To avoid blowing the multimeter's 440 mA fuse, use the  **$\mu\text{A}$  mA** terminal only if you are sure the current is less than 400 mA. See [Figure 2-34](#) for test lead connections and function selection. Refer to the [Input warning](#) section for information on the alerts the multimeter uses when leads are not used correctly for current measurements.
- Placing the probes across (in parallel with) a powered circuit when a lead is plugged into a current terminal can damage the circuit you are testing and blow the multimeter's fuse. This happens because the resistance through the multimeter's current terminals are very low, resulting in a short circuit.

**CAUTION**

- For measuring AC current signals with a DC offset, refer to the **“Using the Filter Function for DC measurements”** on page 61.
  - For measuring DC current from a mixed signal in DC measurement mode, ensure that the Filter is enabled (Refer to **“Enabling the filter”** on page 146).
- 

**NOTE**

- Press  to cycle through the available dual display combinations. See **Appendix B, “Dual Display Combinations Using the Dual Key,”** starting on page 155 to learn more.
  - Press  to measure the frequency of the AC or DC current source. See **“Measuring Frequency”** on page 100 to learn more.
-

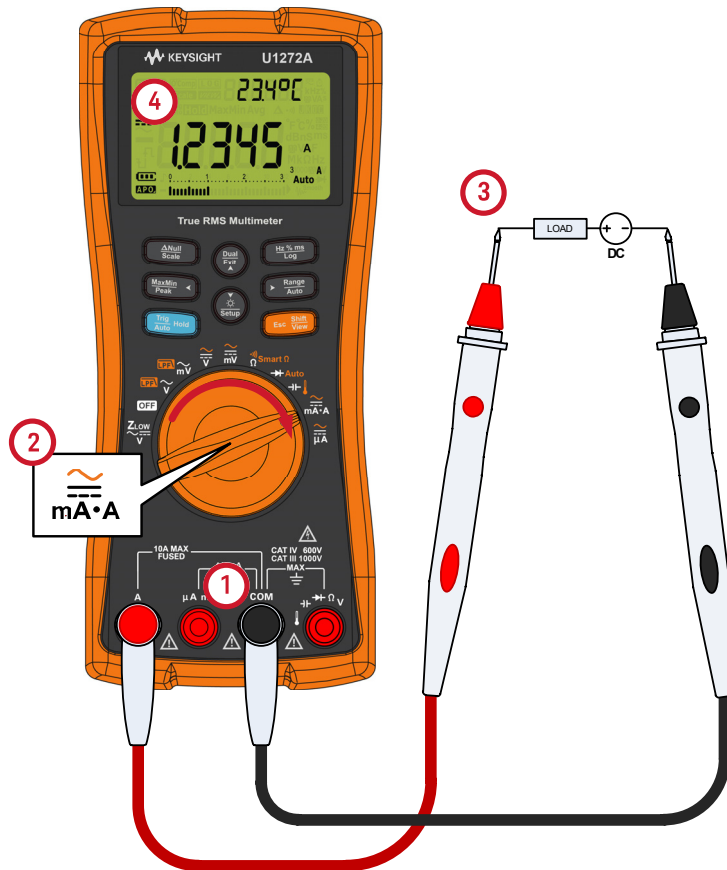

Figure 2-32 Measuring DC current

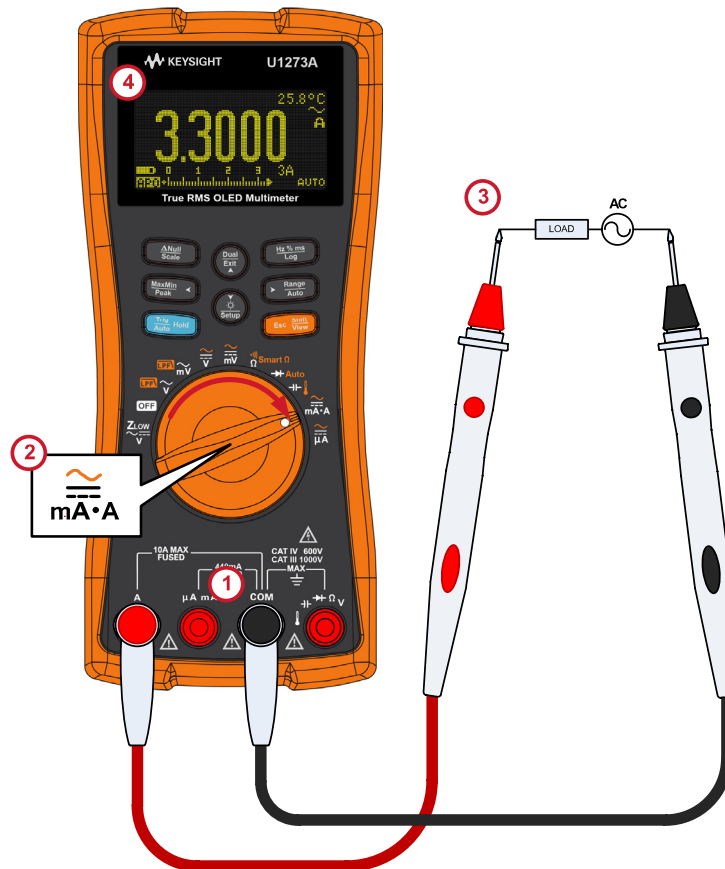

Figure 2-33 Measuring AC current

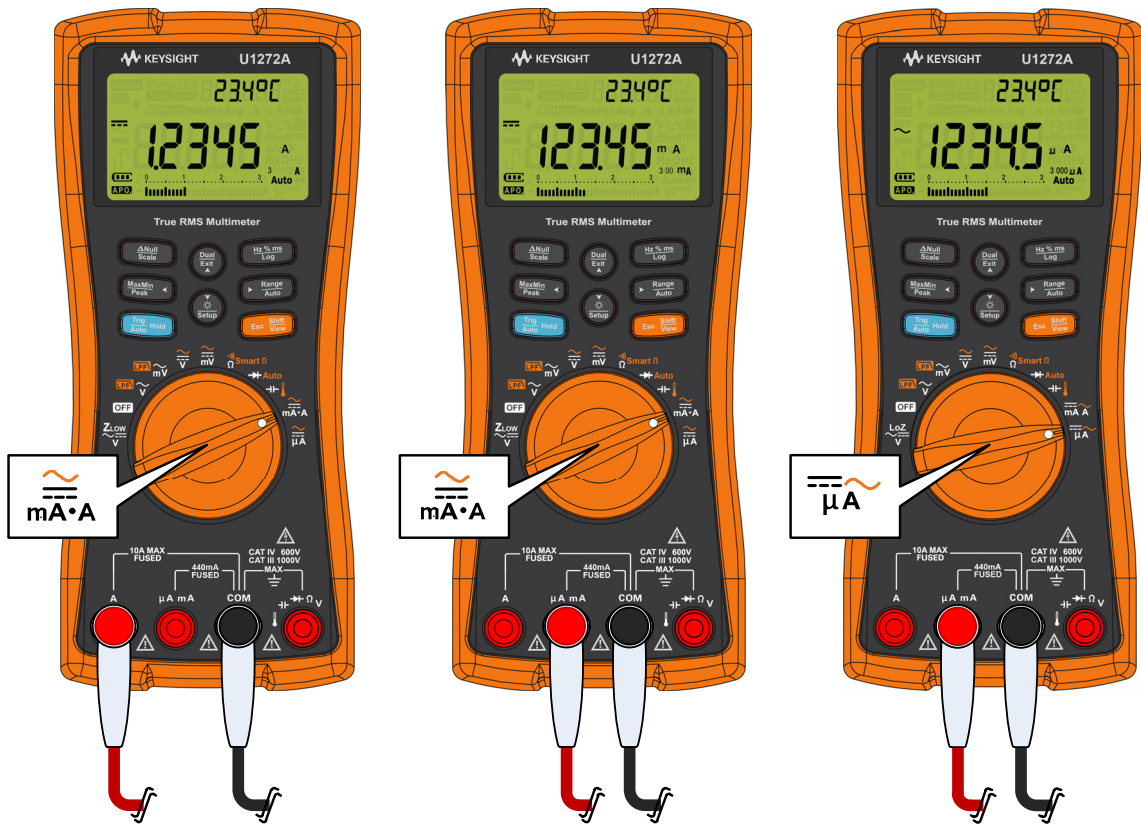





Figure 2-34 Current measurement setup



## % Scale of 4-20 mA or 0-20 mA

To display the current measurement in % scale, position your multimeter's rotary switch position to  and set up your multimeter to measure DC current by following the steps listed in the [Measuring AC or DC Current](#) section.

**Table 2-18** Rotary switch positions allowing current measurements

Legend	Default function	Function when  is pressed
	DC A (or mA)	Cycles between <ul style="list-style-type: none"> <li>- AC A (or mA),</li> <li>- AC+DC A (or mA)</li> <li>- % Scale of 4-20 mA (or 0-20 mA), or</li> <li>- DC A (or mA)</li> </ul>

**NOTE**

- The 4-20 mA current loop output from a transmitter is a type of electrical signal that is used in a series circuit to provide a robust measurement signal that is proportional to the applied pressure, temperature, or flow in process control. The signal is a current loop where 4 mA represents the zero percent signal and 20 mA represents the 100 percent signal.
- The % scale for 4-20 mA or 0-20 mA in this multimeter is calculated using its corresponding DC mA measurement. The multimeter will automatically optimize the best resolution for the selected measurement. Two ranges are available for the % scale as shown in [Table 2-19](#).

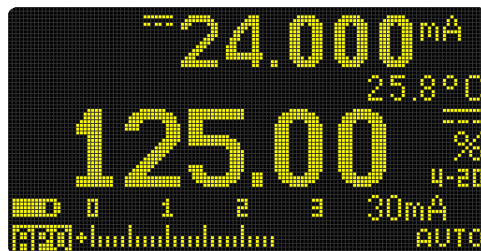

**Figure 2-35** 4-20 mA % Scale display

The analog bar graph displays the current measurement value. (In the example above, 24 mA is represented as 125% in the 4-20 mA % scale.)

**Table 2-19** % Scale measurement range

% Scale of 4-20 mA or 0-20 mA	DC mA measurement range
999.99%	
9999.9%	30 mA or 300 mA <sup>[a]</sup>

[a] Applies to both autoranging and manual range selection.

You can change the % scale range (4-20 mA or 0-20 mA) by accessing the multimeter’s setup. See [“Changing the % scale range”](#) on page 136 for more information.

Use the % scale with a pressure transmitter, a valve positioner, or other output actuators to measure pressure, temperature, flow, pH, or other process variables.



Figure 2-36 Measuring DC current using the 0-20 mA % scale







## Measuring Frequency

### WARNING

Never measure the frequency where the voltage or current level exceeds the specified range. Manually set the voltage or current range if you want to measure frequencies below 20 Hz.

Your multimeter allows simultaneous monitoring of real-time voltage or current with frequency, duty cycle, or pulse width measurements. [Table 2-20](#) highlights the functions allowing frequency measurements in your multimeter.

**Table 2-20** Rotary switch positions allowing frequency measurements

Legend	Default function	Function when  is pressed
	AC V	AC V with LPF
	AC mV	AC mV with LPF
	DC V	Cycles between <ul style="list-style-type: none"> <li>- AC V,</li> <li>- AC+DC V, or</li> <li>- DC V</li> </ul>
	DC mV	Cycles between <ul style="list-style-type: none"> <li>- AC mV,</li> <li>- AC+DC mV, or</li> <li>- DC mV</li> </ul>
	DC A (or mA)	Cycles between <ul style="list-style-type: none"> <li>- AC A (or mA),</li> <li>- AC+DC A (or mA)</li> <li>- % Scale of 4-20 mA (or 0-20 mA), or</li> <li>- DC A (or mA)</li> </ul>
	DC $\mu$ A	Cycles between <ul style="list-style-type: none"> <li>- AC <math>\mu</math>A,</li> <li>- AC+DC <math>\mu</math>A, or</li> <li>- DC <math>\mu</math>A</li> </ul>

**NOTE**

- Measuring the frequency of a signal helps detect the presence of harmonic currents in neutral conductors and determines whether these neutral currents are the result of unbalanced phases or non-linear loads.
- Frequency is the number of cycles a signal completes each second. Frequency is defined as  $1/\text{Period}$ . Period is defined as the time between the middle threshold crossings of two consecutive, like-polarity edges, as shown in [Figure 2-37](#).
- The multimeter measures the frequency of a voltage or current signal by counting the number of times the signal crosses a threshold level within a specified period of time.

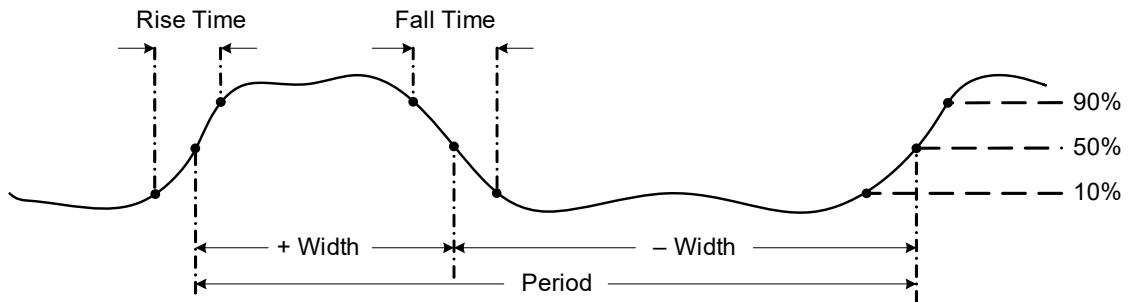

**Figure 2-37** Frequency, pulse width, and duty cycle measurements

Pressing  controls the input range of the primary function (voltage or ampere) and not the frequency range.

- 1 To measure frequency, rotate the switch to one of the primary functions allowing frequency measurements highlighted in [Table 2-20](#).

**NOTE**

To obtain the best measuring results for frequency measurements, please use the AC measuring path.

- 2 Press . Probe the test points, and read the display.

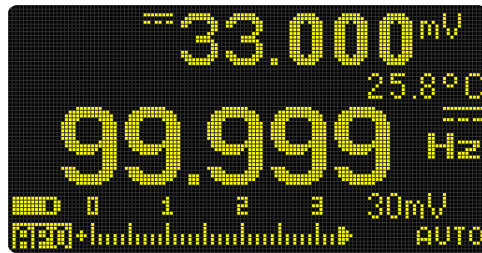

**Figure 2-38** Frequency display

The frequency of the input signal is shown in the primary display. The voltage or ampere value of the signal is shown in the secondary display. The bar graph does not indicate frequency but indicates the voltage or ampere value of the input signal.

#### NOTE

Observe the following measurement techniques:

- If a reading shows as 0 Hz or is unstable, the input signal may be below or near the trigger level. You can usually correct these problems by manually selecting a lower input range, which increases the sensitivity of the multimeter.
- If a reading seems to be a multiple of what you expect, the input signal may be distorted. Distortion can cause multiple triggerings of the frequency counter. Selecting a higher voltage range might solve this problem by decreasing the sensitivity of the multimeter. In general, the lowest frequency displayed is the correct one.

Press  to cycle through the frequency, pulse width, and duty cycle measurements.

Press  for more than 1 second to exit the frequency measurement function.

## Measuring pulse width

### NOTE

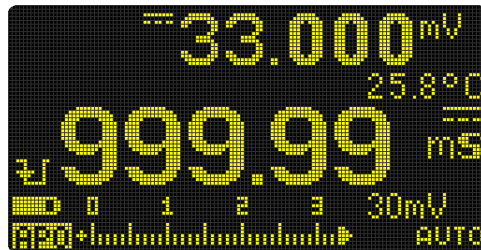

The pulse width function measures the amount of time a signal is high or low, as shown in [Figure 2-37](#). It is the time from the middle threshold of the rising edge to the middle threshold of the next falling edge. The measured waveform must be periodic; its pattern must repeat at equal time intervals.

- 1 To measure pulse width, position the rotary switch to one of the functions allowing frequency measurements shown in [Table 2-20](#).
- 2 Press  until the measurements are shown in the millisecond (**ms**) unit. Probe the test points, and read the display.



**Figure 2-39** Pulse width display

The pulse width of the input signal is shown in the primary display. The voltage or ampere value of the signal is shown in the secondary display. The bar graph does not indicate duty cycle but indicates the voltage or ampere value of the input signal.

The pulse width polarity is displayed to the left of the duty cycle value.  indicates a positive pulse width and  indicates a negative pulse width. To change the polarity being measured, press .

Press  to cycle through the frequency, pulse width, and duty cycle measurements.

Press  for more than 1 second to exit the pulse width measurement function.

## Measuring duty cycle

### NOTE

The duty cycle (or duty factor) of a repetitive pulse train is the ratio of the positive or negative pulse width to the period expressed as a percentage, as shown in [Figure 2-37](#).

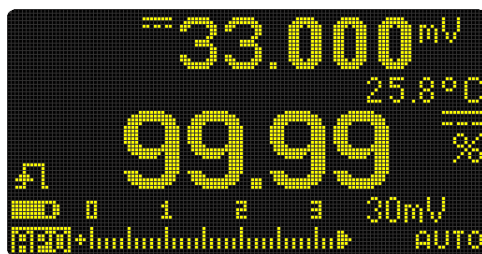

The duty-cycle function is optimized for measuring the on or off time of logic and switching signals. Systems such as electronic fuel injection systems and switching power supplies are controlled by pulses of varying width, which can be checked by measuring the duty cycle.

- 1 To measure the duty cycle, position the rotary switch on one of the functions allowing frequency measurements shown in [Table 2-20](#).
- 2 Press  until the measurements are displayed as a percentage (%). Probe the test points, and read the display.



**Figure 2-40** Duty cycle display

The duty cycle percentage of the input signal is shown in the primary display. The voltage or ampere value of the signal is shown in the secondary display. The bar graph does not indicate duty cycle but indicates the voltage or ampere value of the input signal.

The pulse polarity is displayed to the left of the duty cycle value.  indicates a positive pulse and  indicates a negative pulse. To change the polarity being measured, press .

Press  to cycle through the frequency, pulse width, and duty cycle measurements.

Press  for more than 1 second to exit the duty cycle measurement function.



# 3 Multimeter Features

Making Relative Measurements (Null)	106
Making Scale Transfers (Scale)	108
Capturing Maximum and Minimum Values (MaxMin)	110
Capturing Peak Values (Peak)	112
Freezing the Display (TrigHold and AutoHold)	114
Recording Measurement Data (Data Logging)	115
Reviewing Previously Recorded Data (View)	120

The following sections describe the additional features available in your multimeter.



## Making Relative Measurements (Null)

When making null measurements, also called relative, each reading is the difference between a stored (selected or measured) null value and the input signal.

One possible application is to increase the accuracy of a resistance measurement by nulling the test lead resistance. Nulling the leads is also particularly important prior to making capacitance measurements.



### NOTE

Null can be set for both auto and manual range settings, but not in the case of an overload.

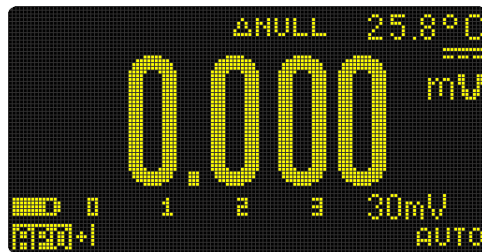
- 1 To activate the relative mode, press the  key. The measurement value at the time that when Null ( is enabled, is stored as the reference value.



**Figure 3-1** Null display

- 2 Press  again to view the stored reference value (). The display will return to normal after 3 seconds.
- 3 To disable the Null function, press  while the stored reference value is shown (step 2).

For any measurement function, you can directly measure and store the null value by pressing  with the test leads open (nulls the test lead capacitance), shorted (nulls the test lead resistance), or across a desired null value circuit.

**NOTE**

- In resistance measurement, the multimeter will read a non-zero value even when the two test leads are in direct contact, because of the resistance of these leads. Use the null function to zero-adjust the display.
- For DC voltage measurements, the thermal effect will influence the accuracy of the measurements. Short the test leads and press  when the displayed value is stable to zero-adjust the display.

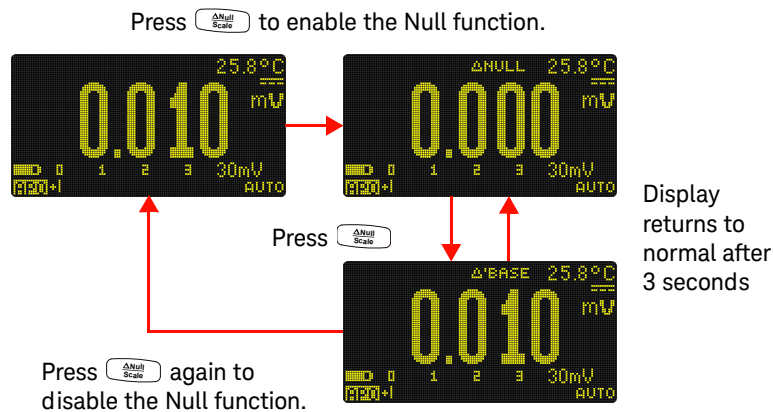
**Figure 3-2** Null operation

## Making Scale Transfers (Scale)





The Scale operation emulates a transducer by helping you to convert the measured readings proportionally to the specified ratio and unit display. Use Scale to transfer voltage readings to proportional readings when using clamp-on current probes or high voltage probes. The available scale conversions are shown in the table below.

**Table 3-1** Available scale conversions



Scale conversion		Multiplier <sup>[a]</sup>	Unit	Related units
1 kV/V <sup>[b]</sup>	1000 V/V	1000.0	V	V, kV
1 A/mV	1000 A/V	1000.0	A	A, kA
1 A/10 mV	100A/V	100.0	A	A, kA
1 A/100 mV	10 A/V	10.0	A	mA, A, kA

[a] The transfer formula used is: Display = Multiplier × Measurement

[b] This value and unit can be adjusted from the multimeter's setup. See "Changing the user scale conversion value and unit" on page 144 for more information.

- 1 Press and hold  for more than 1 second to enable the Scale operation.
- 2 The most recently saved (default: 1 kV/V, ×1000.0) ratio and unit will be shown on the primary and secondary displays. Press  while the **SCALE** symbol is flashing to cycle through the available ratio and unit displays.
- 3 Press  while the **SCALE** symbol is flashing to save the selected ratio and unit and start the conversion. The selected ratio and unit will be used as the default ratio and unit the next time Scale is enabled.
- 4 Or, while the **SCALE** symbol is flashing, if no activity is detected after 3 seconds, the conversion will begin (with the specified ratio and unit shown on the primary display).
- 5 Press and hold  for more than 1 second to cancel the Scale operation.

### NOTE

The  is disabled during Scale operations. Press  to measure the frequency of the voltage and current source during Scale operations.

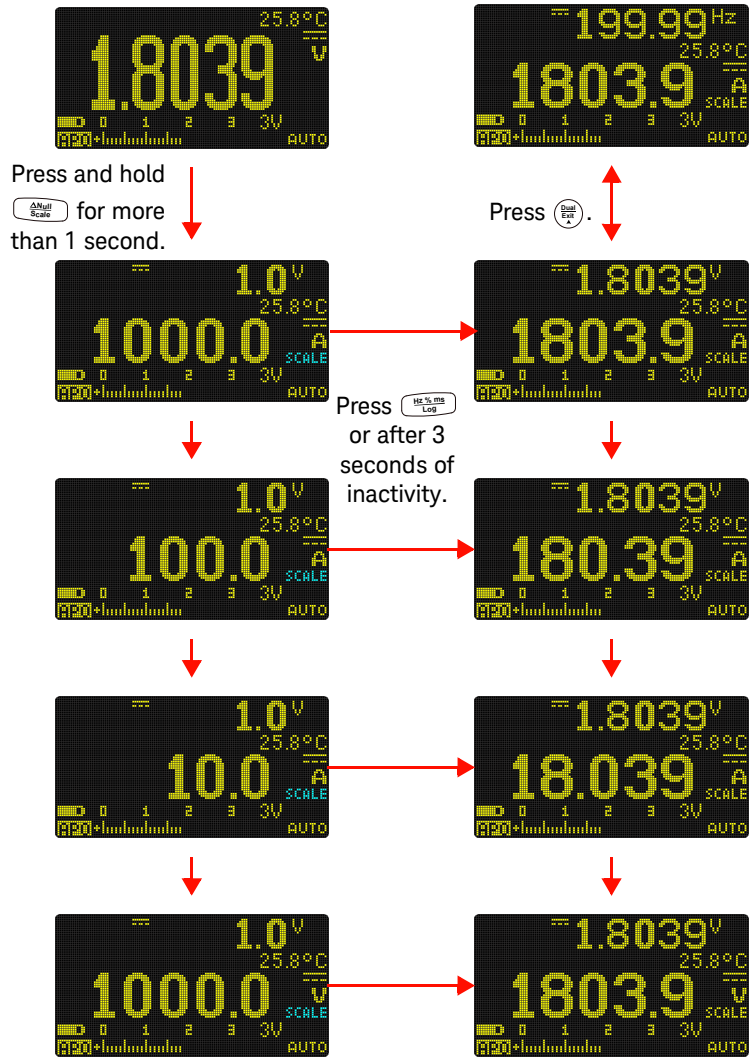

Figure 3-3 Scale operation



## Capturing Maximum and Minimum Values (MaxMin)

The MaxMin operation stores the maximum, minimum, and average input values during a series of measurements.

When the input goes below the recorded minimum value or above the recorded maximum value, the multimeter beeps and records the new value. The elapsed time since the recording session was started is stored and shown on the display at the same time. The multimeter also calculates an average of all readings taken since the MaxMin mode was activated.

From the multimeter's display, you can view the following statistical data for any set of readings:

- **REC MAX:** highest reading since the MaxMin function was enabled
- **REC MIN:** lowest reading since the MaxMin function was enabled
- **REC AVG:** average or mean of all readings since the MaxMin function was enabled
- **REC NOW:** present reading (actual input signal value)

- 1 Press  to enable the MaxMin operation.
- 2 Press  again to cycle through the **MAX**, **MIN**, **AVG**, or **NOW** (present) input values.

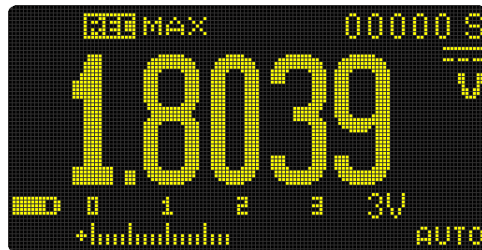



**Figure 3-4** MaxMin display

- 3 The elapsed time is shown on the secondary display. Press  to restart the recording session.

**NOTE**

- Changing the range manually will also restart the recording session.
- You can also use the MaxMin function while measuring frequency (see “Measuring Frequency” on page 100). If the measured frequency shown is not reflected accurately, press  again to restart the recording session.
- If an overload is recorded, the averaging function will be stopped. **OL** is shown in place of the average value.
- The APO (auto power-off) function is disabled when MaxMin is enabled.
- The maximum recording time is 99999 seconds (1 day, 3 hours, 46 minutes, 39 seconds). **OL** is shown if the recording exceeds the maximum time.



- 4** Press  or  for more than 1 second to disable the MaxMin function.

This mode is useful for capturing intermittent readings, recording minimum and maximum readings unattended, or recording readings while equipment operation keeps you from observing the multimeter display.

The true average value displayed is the arithmetic mean of all readings taken since the start of recording. The average reading is useful for smoothing out unstable inputs, calculating power consumption, or estimating the percentage of time a circuit is active.



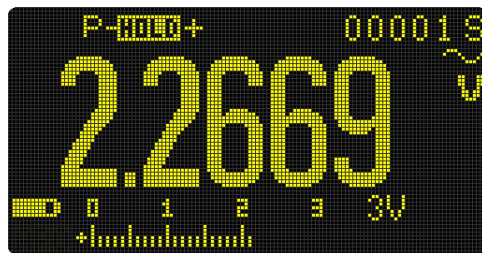

## Capturing Peak Values (Peak)

This function allows the measurement of peak voltage for analysis of such components as power distribution transformers and power factor correction capacitors.

- 1 To activate the peak mode, press the  key for more than 1 second.
- 2 Press  again to display the maximum (**P-HOLD+**) or minimum (**P-HOLD-**) peak values along with their respective time stamps.



**Figure 3-5** Peak display

- 3 If **OL** (overload) is shown, press the  key to change the measurement range. This action will also restart the recording session.
- 4 Press  to restart the recording session without changing the measurement range.
- 5 Press  or  for more than 1 second to disable the Peak function.

When the peak value of the input signal goes below the recorded minimum value or above the recorded maximum value, the multimeter beeps and records the new value. At the same time, the elapsed time since the peak recording session was started is stored as the recorded value's time stamp.

### NOTE

The APO (auto power-off) function is disabled when Peak is enabled.



### To calculate the crest factor:

Crest factor is a measure of signal distortion and is calculated as a signal's peak value over its RMS value. This is an important measurement when looking at power quality issues. In the measurement example shown below (Figure 3-6), the crest factor is calculated as:

$$\text{Crest factor} = \frac{\text{Peak value}}{\text{True RMS value}} = \frac{2.2669 \text{ V}}{1.6032 \text{ V}} = 1.414$$

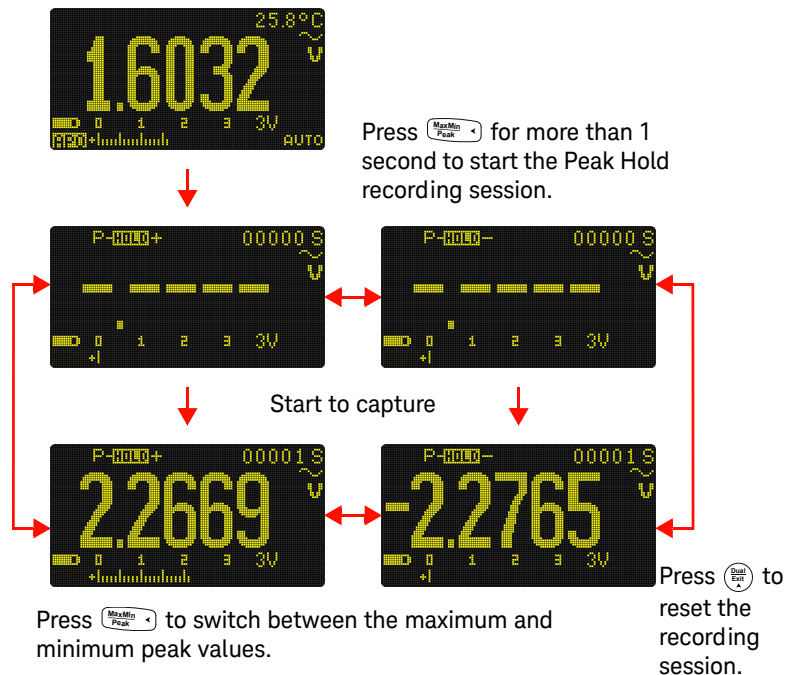

**Figure 3-6** Peak mode operation

## Freezing the Display (TrigHold and AutoHold)

### TrigHold operation

To freeze the display for any function, press the  key.

### AutoHold operation

Pressing the  for more than 1 second activates the AutoHold if the multimeter is not in the MaxMin, Peak, or Data Logging recording modes.

AutoHold operation monitors the input signal and updates the display and, if enabled, emits a beep, whenever a new stable measurement is detected. A stable measurement is one that does not vary more than a selected adjustable (AutoHold threshold) variation count for at least one second (default 500 counts). Open lead conditions are not included in the update.

To change the default AutoHold threshold count see [“Changing the variation count”](#) on page 132 for more information.

#### NOTE

If the reading value is unable to reach a stable state (when exceeding the preset variation), the reading value will not be updated.

---

## Recording Measurement Data (Data Logging)

The Data Logging function provides you the convenience of recording test data for future review or analysis. Since data is stored in the nonvolatile memory, the data remains saved even when the multimeter is turned OFF or if the battery is replaced.

The Data Logging feature collects measurement information over a user-specified duration. There are three data logging options that can be used to capture measurement data: manual (**HAND**), interval (**AUTO**), or event (**TRIG**).

- A manual log stores an instance of the measured signal each time  is pressed. See [page 116](#).
- An interval log stores a record of the measured signal at a user-specified interval. See [page 116](#).
- An event log stores a record of the measured signal each time a trigger condition is satisfied. See [page 118](#).

**Table 3-2** Data logging maximum capacity

Data logging option	Maximum capacity for saving
Manual ( <b>HAND</b> )	100
Interval ( <b>AUTO</b> )	10000
Event ( <b>TRIG</b> )	<i>Shares the same memory with Interval logging</i>

Before starting a recording session, set up the multimeter for the measurements to be recorded.

To change the data logging option see [“Changing the recording option”](#) on page 132 for more information.

## Performing manual logs (HAND)

Ensure that **HAND** is selected as the data logging option in the multimeter's setup.

1 Press  for more than 1 second to store the present input signal value.

 and the log entry number are displayed at the right of the display. The display will return to normal after a short while (around 1 s).



**Figure 3-7** Manual log display

2 Repeat [step 1](#) again to save the next input signal value.

The maximum number of readings that can be stored for the manual log is 100 entries. When all entries are occupied, **H : FULL** will be shown when  is pressed.

See the [Reviewing Previously Recorded Data \(View\)](#) section later in this manual to review or erase the recorded entries.

## Performing interval logs (AUTO)

Ensure that **AUTO** is selected as the data logging option in the multimeter's setup.

The default recording interval duration is 1 second. To change the recording interval duration, see [“Changing the sample interval duration”](#) on page 133 for more information.

The duration set in the multimeter's setup will determine how long each recording interval takes. The input signal value at the end of each interval will be recorded and saved into the multimeter's memory.

## Start the interval log mode

1 Press  for more than 1 second to start interval log mode.

 and the log entry number are displayed at the right of the display. Subsequent readings are automatically recorded into the multimeter's memory at the interval specified in the setup menu.

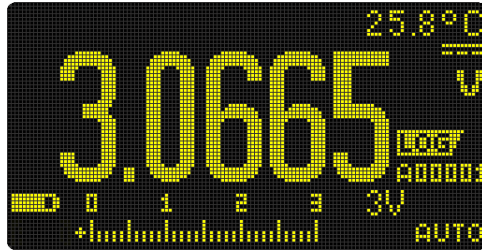

**Figure 3-8** Interval log display

2 Press  for more than 1 second to exit the interval log mode.

The maximum number of readings that can be stored for the interval log is 10000 entries. When all entries are occupied, **A : FULL** will be shown when  is pressed.

The interval and event log share the same memory buffer. Increased usage of the interval log entries will lead to the decrease of the maximum entries for the event log, and vice versa.

See the [Reviewing Previously Recorded Data \(View\)](#) section later in this manual to review or erase the recorded entries.

### NOTE

When the interval log recording session is running, all other keypad operations are disabled; except for , which, when pressed for more than 1 second, will stop and exit the recording session. Furthermore, APO (auto power-off) is disabled during the recording session.

## Performing event logs (TRIG)

Ensure that **TRIG** is selected as the data logging option in the multimeter's setup.

Event logs are used only with the following modes:

- TrigHold and AutoHold (page 114)
- MaxMin recording (page 110)
- Peak recording (page 112)

Event records are triggered by the measured signal satisfying a trigger condition set by the measurement function used in the following modes:

**Table 3-3** Event log trigger conditions

Modes	Trigger condition
	The input signal value is recorded:
TrigHold	Each time  is pressed.
AutoHold	When the input signal varies more than the variation count.
MaxMin	When a new maximum (or minimum) value is recorded. The average and present readings are not recorded in the Event log.
Peak	When a new peak (maximum or minimum) value is recorded.

### Start the event log mode

- 1 Select one of the four modes stated in Table 3-3.
- 2 Press  for more than 1 second to start event log mode.

 and the log entry number are displayed at the right of the display. Subsequent readings are automatically recorded into the multimeter's memory every time the trigger condition specified in Table 3-3 is satisfied.

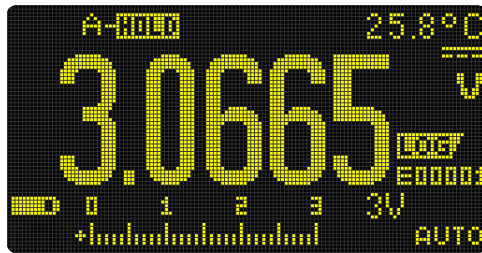

**Figure 3-9** Event log display

**3** Press  for more than 1 second to exit the event log mode.

The maximum number of readings that can be stored for the event log is 10000 entries. When all entries are occupied, **E : FULL** will be shown when  is pressed.

The event and interval log share the same memory buffer. Increased usage of the event log entries will lead to the decrease of the maximum entries for the interval log, and vice versa.



See the [Reviewing Previously Recorded Data \(View\)](#) section later in this manual to review or erase the recorded entries.

#### NOTE

APO (auto power-off) is disabled during the recording session.

## Reviewing Previously Recorded Data (View)

Viewing data stored in the multimeter's memory is performed through the  key.

- 1 Press  for more than 1 second to enter the multimeter's View mode. Press  again to cycle through the manual (**H**), interval (**A**), or event (**E**) previously stored records.





**Figure 3-10** View display



If nothing has been recorded, **H : Void**, **A : Void**, or **E : Void** will be displayed instead.



**Figure 3-11** Empty view display

- 2 Select the desired recording category to view its entries.
  - 1 Press  to jump to the first stored entry.
  - 2 Press  to jump to the last stored entry.
  - 3 Press  to view the next stored entry. The index number increases by one.



- 4 Press  to view the previous stored entry. The index number decreases by one.
- 5 Press  for more than 1 second to clear all entries for the selected log type.
- 3 Press  for more than 1 second to exit the View mode.

## Sanitizing the Log Memories

You have the option to sanitize the log memories of your multimeter. This operation erases the log memories of your multimeter thoroughly. The data stored in the multimeter's memory will not be able to be reconstructed in any way after the data sanitization operation.

Prior to sanitizing the log memories, ensure that all manual (**H**), interval (**A**), or event (**E**) entries have been cleared (see [step 5](#)).

When all entries are cleared (**H : Void**, **A : Void**, and **E : Void**), press and hold  for more than 1 second.

### CAUTION

The data sanitization operation may take up to 30 seconds to complete. Do not press any keys or turn the rotary switch until the data sanitization operation is completed.

THIS PAGE HAS BEEN INTENTIONALLY LEFT BLANK.

# 4 Multimeter Setup Options

Using the Setup Menu	124
Setup Menu Summary	127
Setup Menu Items	132

The following sections describe how to change the preset features of your multimeter.

















## Using the Setup Menu

The multimeter's setup menu allows you to change a number of nonvolatile preset features. Modifying these settings affects the general operation of your multimeter across several functions. Select a setting to edit to perform one of the following actions:

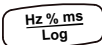
- Switch between two values, such as on or off.
- Cycle through multiple values from a predefined list.
- Decrease or increase a numerical value within a fixed range.



The contents of the setup menu are summarized in [Table 4-2](#) on page 127.



**Table 4-1** Setup menu key functions



Legend	Description
	Press  for more than 1 second to access the setup menu. Press and hold  until the multimeter restarts to exit the setup menu.
 	Press  or  to browse each menu page.
 	Press  or  at each menu page to move the cursor to a specific menu item.
	Press  to edit the selected menu item. The menu item's value will flash to indicate that you can now change the value shown. Press  or  again to switch between two values, to cycle through multiple values from a list, or to decrease or increase a numerical value. Press  to save your changes.
	While the menu item's value is flashing, press  to discard your changes.



## Editing numerical values

When editing numerical values, use the  and  to position the cursor on a numerical digit.

- Press  to move the cursor to the left, and
- Press  to move the cursor to the right.

When the cursor is positioned over a digit, use the  and  keys to change the numerical digit.



- Press  to increment the digit, and
- Press  to decrement the digit.

When you have completed your changes, save the new numerical value by pressing . (Or alternatively, if you wish to discard the changes you made, press .)



#### 4 Multimeter Setup Options

Press and hold  for more than 1 second to enter the setup menu.

Press  to edit the selected menu item's value.

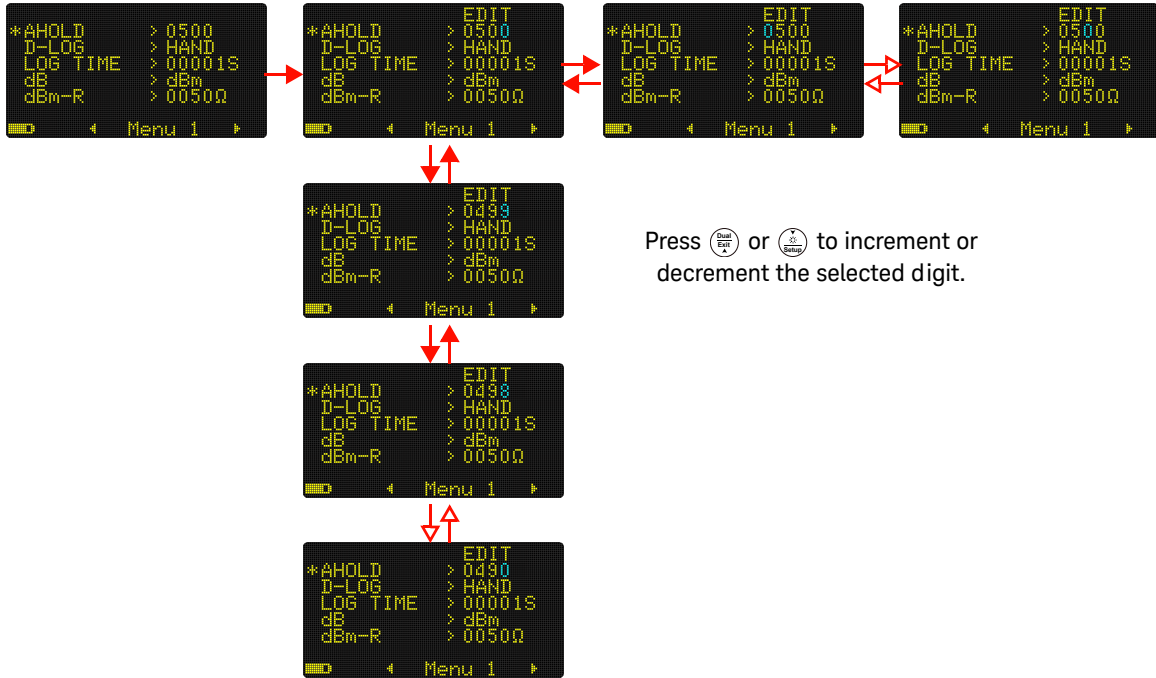
Press  or  to move the cursor left or right.



Press  or  to increment or decrement the selected digit.

## Setup Menu Summary

The setup menu items are summarized in the table below. Click the respective “Learn more” pages for more information on each menu item.

**Table 4-2** Setup menu item descriptions

Menu	Legend	Available settings	Description	Learn more on:
	AHOLD	0050 to 9999	Set the multimeter’s AutoHold threshold count from 50 to 9 999 counts. Default is 500 counts.	<a href="#">page 114</a> and <a href="#">page 132</a>
	D-LOG	HAND, AUTO, or TRIG	Set the multimeter’s data logging option (HAND: manual log, AUTO: interval log, or TRIG: event log). Default is manual log.	<a href="#">page 115</a> and <a href="#">page 132</a>
MENU 1	LOG TIME	00001 S to 99999 S	Set the logging duration for interval logs from 1 to 99999 seconds (1 day, 3 hours, 46 minutes, 39 seconds). Default is 1 second.	<a href="#">page 116</a> and <a href="#">page 133</a>
	dB	dBm, dBV, or OFF	Set the multimeter to display voltage as a dB value (dBm or dBV). You can also disable this feature (off). Default is dBm.	<a href="#">page 64</a> and <a href="#">page 133</a>
	dBm-R	0001 $\Omega$ to 9999 $\Omega$	Set the dBm reference impedance value from 1 $\Omega$ to 9999 $\Omega$ . Default is 50 $\Omega$ .	<a href="#">page 64</a> and <a href="#">page 134</a>

**Table 4-2** Setup menu item descriptions (continued)

Menu	Legend	Available settings	Description	Learn more on:
MENU 2	T-TYPE	J or K	Set the multimeter's thermocouple type (type J or type K). Default is type K.	<a href="#">page 87</a> and <a href="#">page 135</a>
	T-UNIT	°C, °F/°C, °C/°F, or °F	Set the multimeter's temperature unit (Celsius, Fahrenheit/Celsius, Celsius/Fahrenheit, or Fahrenheit). Default is °C (Celsius).	<a href="#">page 87</a> and <a href="#">page 135</a>
	mA SCALE	0-20 mA, 4-20 mA, or OFF	Set the multimeter's % scale selection (0-20 mA or 4-20 mA). You can also disable this feature (off). Default is 4-20 mA.	<a href="#">page 97</a> and <a href="#">page 136</a>
	CONTINUITY	SINGLE, TONE, or OFF	Set the multimeter to sound a single beep or a tone during continuity alerts. You can also disable this feature (off). Default is single.	<a href="#">page 73</a> and <a href="#">page 137</a>
	MIN-Hz	0.5 Hz or 10 Hz	Set the minimum measurement frequency (0.5 Hz or 10 Hz). Default is 0.5 Hz.	<a href="#">page 100</a> and <a href="#">page 137</a>



**Table 4-2** Setup menu item descriptions (continued)

Menu	Legend	Available settings	Description	Learn more on:
MENU 3	BEEP	3200 Hz, 3491 Hz, 3840 Hz, 4267 Hz, or OFF	Set the multimeter's beep frequency from 3200 Hz to 4267 Hz. You can also disable this feature (off). Default is 3491 Hz.	<a href="#">page 138</a>
	APO	01 M to 99 M (E or D)	Set the auto power-off timer period from 1 to 99 minutes (1 hour, 39 minutes). You can also disable this feature (D). Default is 10 minutes (10 M-E).	<a href="#">page 26</a> and <a href="#">page 138</a>
	BACKLIT	LOW, MEDIUM, HIGH, or AUTO	Set the default OLED behavior from low to high. You can also set the OLED to auto-dim instead (AUTO). Default is auto-dim.	<a href="#">page 27</a> and <a href="#">page 139</a>
	MELODY	FACTORY, USER, or OFF	Set the multimeter's power-on melody to the factory default or off (disable this feature). The user-defined setting is factory reserved. Default is factory.	<a href="#">page 139</a>
	GREETING	FACTORY, USER, or OFF	Set the multimeter's power-on greetings to the factory default or off (disable this feature). The user-defined setting is factory reserved. Default is factory.	<a href="#">page 140</a>

**Table 4-2** Setup menu item descriptions (continued)

Menu	Legend	Available settings	Description	Learn more on:
MENU 4	BAUD	9600 or 19200	Set the baud rate for remote communication with a PC (9600 or 19200). Default is 9600.	page 30 and page 141
	DATA BIT	7 or 8	Set the data bit length for remote communication with a PC (7-bit or 8-bit). Default is 8-bit.	page 30 and page 141
	PARITY	NONE, EVEN, or ODD	Set the parity bit for remote communication with a PC (none, even, or odd). Default is none.	page 30 and page 142
	ECHO	OFF or ON	Set the multimeter to echoes (returns) all the characters it receives. Default is disabled (off).	page 30 and page 142
	PRINT	OFF or ON	Set the multimeter to print out the measured data when the measuring cycle is completed. Default is disabled (off).	page 30 and page 143
	REVISION	-	Displays the multimeter's firmware revision.	-
	S/N	-	Displays the multimeter's serial number (for the last eight digits).	-
MENU 5	V-ALERT	000.01 V to 999.99 V (D or E)	Set the multimeter's voltage alert value from 0.01 V to 999.99 V. You can also disable this feature (D). Default is disabled (030.00-D).	page 28 and page 143
	USER SCALE	0000.1 V to 1000.0 V	Set the scale conversion value from (0000.1) to (1000.0). The scale conversion unit can be set to V/V, A/V, or (no unit)/V. Default is (1000.0) V/V.	page 108 and page 144
	SMOOTH	0001 to 9999 (D or E)	Set the primary display's settling value from 0001 to 9999. You can also disable this feature (D). Default is disabled (0009-D).	page 32 and page 144

**Table 4-2** Setup menu item descriptions (continued)

Menu	Legend	Available settings	Description	Learn more on:
MENU 6	DEFAULT	YES or NO	Reset the multimeter to its factory default settings.	<a href="#">page 145</a>
	BATTERY	PRI or SEC	Change the battery selection from primary to secondary. Default is primary.	<a href="#">page 23</a> and <a href="#">page 146</a>
	FILTER	DC, DCAC, or OFF	Enable the Filter (LPF) for DC, AC, and AC+DC voltage and current measuring paths. Default is DC.	<a href="#">page 58</a> and <a href="#">page 146</a>





## Setup Menu Items

### Changing the variation count

This setting is used with the multimeter's AutoHold feature (see [page 114](#)). When the variation of the measured value exceeds the value of the variation count, the AutoHold feature will be ready to trigger.

Parameter	Range	Default setting
AHOLD	(50 to 9999) counts	0500

To change the variation count:

- 1 Press  for more than 1 second to enter the multimeter's setup menu.
- 2 Browse to **Menu 1 > AHOLD**, and press  edit the value.
- 3 Use the arrow keys to change the variation count.
- 4 Press  to save your changes (or press  to discard your changes).
- 5 Press and hold  until the multimeter restarts to return to normal operation.





### Changing the recording option

This setting is used with the multimeter's Data Logging feature (see [page 115](#)). There are three available recording options for the multimeter's Data Logging feature.

- HAND: Manual log
- AUTO: Interval log
- TRIG: Event log

Parameter	Range	Default setting
D-LOG	HAND, AUTO, or TRIG	HAND

To change the recording option:





- 1 Press  for more than 1 second to enter the multimeter's setup menu.
- 2 Browse to **Menu 1 > D-LOG**, and press  edit the value.
- 3 Use the arrow keys to change the recording option.
- 4 Press  to save your changes (or press  to discard your changes).
- 5 Press and hold  until the multimeter restarts to return to normal operation.

## Changing the sample interval duration

This setting is used with the multimeter's Interval Data Logging feature (see [page 116](#)). The multimeter will record a measurement value at the beginning of every sample interval.

Parameter	Range	Default setting
LOG TIME	(1 to 99999) s	00001 S

To change the sample interval duration:





- 1 Press  for more than 1 second to enter the multimeter's setup menu.
- 2 Browse to **Menu 1 > LOG TIME**, and press  edit the value.
- 3 Use the arrow keys to change the sample interval duration.
- 4 Press  to save your changes (or press  to discard your changes).
- 5 Press and hold  until the multimeter restarts to return to normal operation.

## Changing the decibel display

This setting is used with dB measurements (see [page 64](#)). You can enable the multimeter to display voltage as a dB value, either relative to 1 milliwatt (dBm) or a reference voltage of 1 volt (dBV).

Parameter	Range	Default setting
dB	dBm, dBV, or OFF	dBm

To change the decibel display:





- 1 Press  for more than 1 second to enter the multimeter's setup menu.
- 2 Browse to **Menu 1 > dB**, and press  edit the value.
- 3 Use the arrow keys to change the decibel display. Select **OFF** to disable the decibel display.
- 4 Press  to save your changes (or press  to discard your changes).
- 5 Press and hold  until the multimeter restarts to return to normal operation.

## Changing the custom dBm reference impedance

This setting is used with dB measurements (see [page 57](#)). The dBm function is logarithmic, and is based on a calculation of power delivered to a reference impedance (resistance), relative to 1 mW.

Parameter	Range	Default setting
dBm-R	(1 to 9999) $\Omega$	0050 $\Omega$

To change the dBm reference impedance value:





- 1 Press  for more than 1 second to enter the multimeter's setup menu.
- 2 Browse to **Menu 1 > dBm-R**, and press  edit the value.
- 3 Use the arrow keys to change the dBm reference impedance value.
- 4 Press  to save your changes (or press  to discard your changes).
- 5 Press and hold  until the multimeter restarts to return to normal operation.

## Changing the thermocouple type

This setting is used with temperature measurements (see [page 87](#)). Select a thermocouple type that matches the thermocouple sensor you are using for temperature measurements.

Parameter	Range	Default setting
T-TYPE	Type-J or Type-K	K

To change the thermocouple type:



- 1 Press  for more than 1 second to enter the multimeter's setup menu.
- 2 Browse to **Menu 2 > T-TYPE**, and press  to edit the value.
- 3 Use the arrow keys to change the thermocouple type.
- 4 Press  to save your changes (or press  to discard your changes).
- 5 Press and hold  until the multimeter restarts to return to normal operation.

## Changing the temperature unit

### CAUTION

This setup item is locked for certain regions. Always set the temperature unit display per the official requirements and in compliance with the National laws of your region.







This setting is used with temperature measurements (see [page 87](#)). Four combinations of displayed temperature unit(s) are available:

- Celsius only: Temperature measured in °C.
- Fahrenheit/Celsius: During temperature measurements, press  to switch between °F and °C.
- Celsius/Fahrenheit: During temperature measurements, press  to switch between °C and °F.
- Fahrenheit only: Temperature measured in °F.

Press and hold  for more than 1 second to unlock this setting.

Parameter	Range	Default setting
T-UNIT	°C, °F/°C, °C/°F, or °F	°C

To change the temperature unit:





- 1 Press  for more than 1 second to enter the multimeter's setup menu.
- 2 Browse to **Menu 2 > T-UNIT**. Press and hold  for more than 1 second to unlock this setting, then press  to edit the value.
- 3 Use the arrow keys to change the temperature unit.
- 4 Press  to save your changes (or press  to discard your changes).
- 5 Press and hold  until the multimeter restarts to return to normal operation.

## Changing the % scale range

This setting is used with % scale current measurements (see [page 97](#)). The multimeter converts DC current measurements to a percentage scale readout of 0% to 100% based on the selected range in this menu. For example, a 25% readout represents a DC current of 8 mA on the 4-20 mA % scale, or a DC current of 5 mA on the 0-20 mA % scale.

Parameter	Range	Default setting
mA SCALE	4-20 mA, 0-20 mA, or OFF	4-20 mA

To change the % scale range:

- 1 Press  for more than 1 second to enter the multimeter's setup menu.
- 2 Browse to **Menu 2 > mA SCALE**, and press  to edit the value.
- 3 Use the arrow keys to change the % scale range. Select **OFF** to disable the % scale readout.
- 4 Press  to save your changes (or press  to discard your changes).







- 5 Press and hold  until the multimeter restarts to return to normal operation.

## Changing the continuity alert

This setting is used with continuity tests (see [page 73](#)). The multimeter will beep to alert users to the presence of circuit continuities.

Parameter	Range	Default setting
CONTINUITY	SINGLE, TONE, or OFF	SINGLE

To change the continuity alert:



- 1 Press  for more than 1 second to enter the multimeter's setup menu.
- 2 Browse to **Menu 2 > CONTINUITY**, and press  to edit the value.
- 3 Use the arrow keys to change the continuity alert. Select **OFF** to disable the continuity alert.
- 4 Press  to save your changes (or press  to discard your changes).
- 5 Press and hold  until the multimeter restarts to return to normal operation.



## Changing the minimum measurable frequency

This setting is used with frequency tests (see [page 100](#)). Changing the minimum measurable frequency will influence the measurement rates for frequency, duty cycle, and pulse width measurements. The typical measurement rate as defined in the specification is based on a minimum measurable frequency of 10 Hz.

Parameter	Range	Default setting
MIN-Hz	0.5 Hz or 10 Hz	0.5 Hz

To change the minimum measurable frequency:

- 1 Press  for more than 1 second to enter the multimeter's setup menu.
- 2 Browse to **Menu 2 > MIN-Hz**, and press  to edit the value.





- 3 Use the arrow keys to change the minimum measurable frequency.
- 4 Press  to save your changes (or press  to discard your changes).
- 5 Press and hold  until the multimeter restarts to return to normal operation.

## Changing the beep frequency

The multimeter's beeper alerts users to the presence of circuit continuities, operator errors such as incorrect lead connections for the selected function, and newly sensed values for MaxMin and Peak recordings.

Parameter	Range	Default setting
BEEP	3200 Hz, 3491 Hz, 3840 Hz, 4267 Hz, or OFF	3491 Hz

To change the beep frequency:





- 1 Press  for more than 1 second to enter the multimeter's setup menu.
- 2 Browse to **Menu 3 > BEEP**, and press  edit the value.
- 3 Use the arrow keys to change the beep frequency. Select **OFF** to disable the beeper.
- 4 Press  to save your changes (or press  to discard your changes).
- 5 Press and hold  until the multimeter restarts to return to normal operation.

## Changing the auto power-off (APO) timer

The multimeter's APO (see [page 26](#)) feature uses a timer to determine when to automatically turn the multimeter off.

Parameter	Range	Default setting
APO	- (1 to 99) minutes - E(nabled) or D(isabled)	10 M-E

To change the APO timer period:





- 1 Press  for more than 1 second to enter the multimeter's setup menu.
- 2 Browse to **Menu 3 > APO**, and press  edit the value.
- 3 Use the arrow keys to change the APO timer period. Select **D** to disable the APO feature.
- 4 Press  to save your changes (or press  to discard your changes).
- 5 Press and hold  until the multimeter restarts to return to normal operation.

## Changing the OLED behavior

The multimeter's OLED is set to auto-dim by default. However, you can manually control the OLED brightness by changing the values in this setup item.

Parameter	Range	Default setting
BACKLIT	AUTO, LOW, MEDIUM, or HIGH	AUTO

To change the OLED behavior:





- 1 Press  for more than 1 second to enter the multimeter's setup menu.
- 2 Browse to **Menu 3 > BACKLIT**, and press  edit the value.
- 3 Use the arrow keys to change the OLED behavior. Select **AUTO** to enable the auto-dim feature.
- 4 Press  to save your changes (or press  to discard your changes).
- 5 Press and hold  until the multimeter restarts to return to normal operation.

## Changing the power-on melody

The multimeter's plays a melody when it is powered on. The **USER** setting is factory reserved.

Parameter	Range	Default setting
MELODY	FACTORY, USER, or OFF	FACTORY

To change the power-on melody:





- 1 Press  for more than 1 second to enter the multimeter's setup menu.
- 2 Browse to **Menu 3 > MELODY**, and press  to edit the value.
- 3 Use the arrow keys to change the power-on melody. Select **OFF** to disable the power-on melody.
- 4 Press  to save your changes (or press  to discard your changes).
- 5 Press and hold  until the multimeter restarts to return to normal operation.

## Changing the power-on greetings

The multimeter displays the Keysight logo when it is powered on. You can turn off the power-on display by changing the default setting to **OFF**. The **USER** setting is factory reserved.

Parameter	Range	Default setting
GREETING	FACTORY, USER, or OFF	FACTORY

To change the power-on greetings:





- 1 Press  for more than 1 second to enter the multimeter's setup menu.
- 2 Browse to **Menu 3 > GREETING**, and press  to edit the value.
- 3 Use the arrow keys to change the power-on greetings. Select **OFF** to disable the power-on greetings.
- 4 Press  to save your changes (or press  to discard your changes).
- 5 Press and hold  until the multimeter restarts to return to normal operation.

## Changing the baud rate

This setting changes the baud rate for remote communications with a PC.

Parameter	Range	Default setting
BAUD	(9600 or 19200) bits/second	9600

To change the baud rate:





- 1 Press  for more than 1 second to enter the multimeter's setup menu.
- 2 Browse to **Menu 4 > BAUD**, and press  to edit the value.
- 3 Use the arrow keys to change the baud rate.
- 4 Press  to save your changes (or press  to discard your changes).
- 5 Press and hold  until the multimeter restarts to return to normal operation.

## Changing the data bits

This setting changes the number of data bits (data width) for remote communications with a PC. The number of stop bit is always 1, and this cannot be changed.

Parameter	Range	Default setting
DATA BIT	8-bit or 7-bit	8

To change the data bit:





- 1 Press  for more than 1 second to enter the multimeter's setup menu.
- 2 Browse to **Menu 4 > DATA BIT**, and press  to edit the value.
- 3 Use the arrow keys to change the data bit.
- 4 Press  to save your changes (or press  to discard your changes).
- 5 Press and hold  until the multimeter restarts to return to normal operation.

## Changing the parity check

This setting changes the parity check for remote communications with a PC.

Parameter	Range	Default setting
PARITY	NONE, EVEN, or ODD	NONE

To change the parity check:





- 1 Press  for more than 1 second to enter the multimeter's setup menu.
- 2 Browse to **Menu 4 > PARITY**, and press  to edit the value.
- 3 Use the arrow keys to change the parity check.
- 4 Press  to save your changes (or press  to discard your changes).
- 5 Press and hold  until the multimeter restarts to return to normal operation.

## Enabling the echo feature

When the echo feature is enabled, the multimeter echoes (returns) all the characters it receives when it is connected to a remote PC.

Parameter	Range	Default setting
ECHO	OFF or ON	OFF

To enable the echo feature:





- 1 Press  for more than 1 second to enter the multimeter's setup menu.
- 2 Browse to **Menu 4 > ECHO**, and press  to edit the value.
- 3 Use the arrow keys to enable the echo feature.
- 4 Press  to save your changes (or press  to discard your changes).
- 5 Press and hold  until the multimeter restarts to return to normal operation.

## Enabling the print feature

When the print feature is enabled, the multimeter will print out the measured data when the measuring cycle is complete. The multimeter will automatically send new data to the remote PC host continuously. The multimeter does not accept any commands from the PC host when this feature is enabled.

Parameter	Range	Default setting
PRINT	OFF or ON	OFF

To enable the print feature:



- 1 Press  for more than 1 second to enter the multimeter's setup menu.
- 2 Browse to **Menu 4 > PRINT**, and press  edit the value.
- 3 Use the arrow keys to enable the print feature.
- 4 Press  to save your changes (or press  to discard your changes).
- 5 Press and hold  until the multimeter restarts to return to normal operation.



## Enabling the overvoltage alert

This setting is used with the multimeter's overvoltage alert (see [page 28](#)). The multimeter's will start beeping periodically once the measured voltage exceeds the value set, regardless of polarity.

Parameter	Range	Default setting
V-ALERT	- (0.01 to 999.99) V - D(isabled) or E(nabled)	(030.00-D) V

To enable the overvoltage's alert:

- 1 Press  for more than 1 second to enter the multimeter's setup menu.
- 2 Browse to **Menu 5 > V-ALERT**, and press  edit the value.





- 3 Use the arrow keys to change the value of the overvoltage's alert. Select **E** to enable the overvoltage alert value.
- 4 Press  to save your changes (or press  to discard your changes).
- 5 Press and hold  until the multimeter restarts to return to normal operation.

## Changing the user scale conversion value and unit

You can set the user scale conversion value and unit. The ratio can be set from 0000.1 to 1000.0 and the unit can be set to V/V, A/V, or (no unit/V). The default is 1000 V/V. See [“Making Scale Transfers \(Scale\)”](#) on page 108 for more information on the Scale operation.

Parameter	Range	Default setting
USER SCALE	(0000.1 to 1000.0) V/V, A/V, or (no unit/V)	1000.0 V(V)

To set the user scale conversion value and unit:

- 1 Press  for more than 1 second to enter the multimeter's setup menu.
- 2 Browse to **Menu 5 > USER SCALE**, and press  edit the value.
- 3 Use the arrow keys to change the user scale conversion value and unit.
- 4 Press  to save your changes (or press  to discard your changes).
- 5 Press and hold  until the multimeter restarts to return to normal operation.

## Enabling smooth mode

Smooth is used to smoothen the refresh rate of the readings in order to reduce the impact of unexpected noise and to help you achieve a stable reading.





The smooth refresh rate can be set from 0001 to 9999. The smooth time is defined as the set value +1. Smooth will be restarted when the variation count is exceeded, when the range is changed, or after a multimeter function or feature is enabled. The variation count is set to the value used for the AutoHold feature (see [“Changing the variation count”](#) on page 132).



You can enable Smooth by holding  while turning on the multimeter (“Power-on options” on page 32). This method, however, is temporary and Smooth will be turned off when you cycle the multimeter’s power. You can permanently enable Smooth from the setup menu.

Parameter	Range	Default setting
SMOOTH	- 0001 to 9999 - D(isabled) or E(nabled)	0009-D(isabled)



To change the smooth refresh rate:



- 1 Press  for more than 1 second to enter the multimeter’s setup menu.
- 2 Browse to **Menu 5 > SMOOTH**, and press  edit the value.
- 3 Use the arrow keys to change the smooth refresh rate. Select **E** to enable the Smooth feature.
- 4 Press  to save your changes (or press  to discard your changes).
- 5 Press and hold  until the multimeter restarts to return to normal operation.

## Resetting the multimeter’s setup options

The multimeter’s setup options can be reset to its default values through the setup menu.

Parameter	Range	Default setting
DEFAULT	YES or NO	NO

- 1 Press  for more than 1 second to enter the multimeter’s setup menu.
- 2 Browse to **Menu 6 > DEFAULT**, and press  edit the value.
- 3 Use the arrow keys to select **YES**.





- 4 Press and hold  for more than 1 second to perform the reset. The multimeter will beep once and return to the first setup menu page. Or, alternatively press  to discard your changes.

## Changing the battery type

If you are using rechargeable batteries to power your multimeter, change the battery type from **PRI** to **SEC** for the multimeter to accurately reflect the battery capacity indication.

Parameter	Range	Default setting
BATTERY	PRI or SEC	PRI

To change the battery type:

- 1 Press  for more than 1 second to enter the multimeter's setup menu.
- 2 Browse to **Menu 6 > BATTERY**, and press  edit the value.
- 3 Use the arrow keys to change the battery type.
- 4 Press  to save your changes (or press  to discard your changes).
- 5 Press and hold  until the multimeter restarts to return to normal operation.

## Enabling the filter

There are two Filter  options within the design of the multimeter:

- In AC/AC+DC measurement mode, the Filter works as a low pass filter and attenuates signals with frequencies of more than 1 kHz
- In DC measurement mode, the Filter will block AC signals

Only one of the two filters can be in the signal path at any point in time. The possible scenarios are:

- Only the AC Low Pass Filter is enabled
- Only the DC Filter is enabled
- No Filter in the signal path

The **LPF** icon appears when either of the LPF circuits are enabled. When either LPF is enabled, the measurement speed (response time) will be impacted.

**NOTE**

The DC Filter cannot be used when the dual display mode is enabled where AC and DC voltages are measured.

**Table 4-3** Filter (LPF) options

Measurement	Filter setting		
	DC <sup>[a]</sup>	DCAC	OFF
<b>AC/AC+DC</b>	OFF	Low Pass Filter	OFF
<b>DC</b>	Filter (blocks AC)	Filter (blocks AC)	OFF
<b>Dual Display</b>	OFF	Low Pass Filter	OFF

[a] The Filter (DC) will be set to ON as the factory default. You may change it to an alternate setting, and the multimeter will remember the chosen setting for consecutive uses.

You may enable the Filter for DC coupling of voltage and/or current measurements. The **LPF** icon will be shown during the measurement.

**Table 4-4** Firmware version 1.64 or older





Parameter	Range	Default setting
FiltEr	on or oFF	oFF

**Table 4-5** Firmware version 1.95 or newer

Parameter	Range	Default setting
FiltEr	dC, dCAC, or oFF	dC

## 4 Multimeter Setup Options

To enable/disable the filter:

- 1 Press  for more than 1 second to enter the multimeter's setup menu.
- 2 Browse to **Menu 6 > FILTER**, and press  to edit the value.
- 3 Use the arrow keys to enable the filter.
- 4 Press  to save your changes (or press  to discard your changes).
- 5 Press and hold  until the multimeter restarts to return to normal operation.



# 5 Characteristics and Specifications

For the characteristics and specifications of the U1273A/U1273AX Handheld Digital Multimeter, refer to the datasheet at <http://literature.cdn.keysight.com/litweb/pdf/5990-6425EN.pdf>.

THIS PAGE HAS BEEN INTENTIONALLY LEFT BLANK.











# Appendix A Shift Functions Using the Shift Key

Table A-1 U1273A/U1273AX default and shift functions 152

The table below lists the function shown in the primary display when the  key is pressed, with respect to the multimeter's rotary switch position. Press  to cycle through the available shift functions.



A Shift Functions Using the Shift Key



**Table A-1** U1273A/U1273AX default and shift functions

Rotary switch position	Function shown in the primary display:	
	Default	When  is pressed
	Low impedance ( $Z_{LOW}$ ) AC or DC voltage measurement (AC/DC V) <sup>[a]</sup>	-
	AC voltage measurement (AC V)	AC voltage measurement (AC V) with low-pass filter (LPF)
	AC voltage measurement (AC mV)	AC voltage measurement (AC mV) with low-pass filter (LPF)
	DC voltage measurement (DC V)	AC voltage measurement (AC V) AC+DC voltage measurement (AC+DC V)
	DC voltage measurement (DC mV)	AC voltage measurement (AC mV) AC+DC voltage measurement (AC+DC mV)
	Resistance measurement ( $\Omega$ )	Continuity test (••) $\Omega$ Resistance measurement ( $\Omega$ ) with offset compensation (Smart $\Omega$ )
	Diode test (V)	Auto-diode test (V)
	Capacitance measurement (F)	Temperature measurement ( $^{\circ}$ C or $^{\circ}$ F)
 With the positive probe inserted into the $\mu$ A mA terminal	DC current measurement (DC mA)	AC current measurement (AC mA) AC+DC current measurement (AC+DC mA) % (0-20 or 4-20) mA
 With the positive probe inserted into the A terminal	DC current measurement (DC A)	AC current measurement (AC A) AC+DC current measurement (AC+DC A) % (0-20 or 4-20) A



**Table A-1** U1273A/U1273AX default and shift functions (continued)



Rotary switch position	Function shown in the primary display:	
	Default	When  is pressed
	DC current measurement (DC $\mu\text{A}$ )	AC current measurement (AC $\mu\text{A}$ ) AC+DC current measurement (AC+DC $\mu\text{A}$ )

[a] Press  to switch the function shown in the primary display (AC V) with the function shown in the secondary display (DC V). Press  again to switch back the displays.

THIS PAGE HAS BEEN INTENTIONALLY LEFT BLANK.

# Appendix B Dual Display Combinations Using the Dual Key











Table B-1 U1273A/U1273AX dual display combinations 156

The table below lists the function shown in the secondary display when the  key is pressed, with respect to the multimeter's rotary switch position. Press  to cycle through the available dual display combinations. Press  for more than 1 second to return to the default secondary display function (ambient temperature measurement).





**WARNING**

In the dual display DC voltage decibel and DC voltage measurement mode, the ⚡ icon will not appear on the screen regardless of voltage.











**Table B-1** U1273A/U1273AX dual display combinations

Rotary switch position	Function shown (when  is pressed) in the:	
	Primary display	Secondary display
	Low impedance ( $Z_{LOW}$ ) AC voltage measurement (V)	Low impedance ( $Z_{LOW}$ ) DC voltage measurement (V)
	<i>Press  to switch the function shown on the primary display (AC V) with the function shown on the secondary display (DC V). Press  again to switch back the functions.</i>	
	AC voltage measurement (AC V)	AC coupling frequency measurement (Hz)
	AC voltage decibel display (dBm) is enabled when  is pressed.	AC voltage measurement (AC V)
	AC voltage measurement (AC V) with low-pass filter (LPF)	AC coupling frequency measurement (Hz)
	AC voltage measurement (AC mV)	AC coupling frequency measurement (Hz)
	AC voltage decibel display (dBm) is enabled when  is pressed.	AC voltage measurement (AC mV)
	AC voltage measurement (AC mV) with low-pass filter (LPF)	AC coupling frequency measurement (Hz)
	AC voltage decibel display (dBm) with low-pass filter (LPF) is enabled when  is pressed.	AC voltage measurement (AC mV) with low-pass filter (LPF)





**Table B-1** U1273A/U1273AX dual display combinations (continued)

Rotary switch position	Function shown (when  is pressed) in the:	
	Primary display	Secondary display
	DC voltage measurement (DC V)	DC coupling frequency measurement (Hz) AC voltage measurement (AC V)
	DC voltage decibel display (dBm) is enabled when  is pressed. <sup>[a]</sup>	DC voltage measurement (DC V)
	AC voltage measurement (AC V)	AC coupling frequency measurement (Hz) DC voltage measurement (DC V)
	AC voltage decibel display (dBm) is enabled when  is pressed.	AC voltage measurement (AC V)
	AC+DC voltage measurement (AC+DC V)	AC coupling frequency measurement (Hz) AC voltage measurement (AC V) DC voltage measurement (DC V)
	AC+DC voltage decibel display (dBm) is enabled when  is pressed.	AC+DC voltage measurement (AC+DC V)

**Table B-1** U1273A/U1273AX dual display combinations (continued)

Rotary switch position	Function shown (when  is pressed) in the:	
	Primary display	Secondary display
	DC voltage measurement (DC mV)	DC coupling frequency measurement (Hz) AC voltage measurement (AC mV)
	DC voltage decibel display (dBm) is enabled when  is pressed. <sup>[a]</sup>	DC voltage measurement (DC mV)
	AC voltage measurement (AC mV)	AC coupling frequency measurement (Hz) DC voltage measurement (DC mV)
	AC voltage decibel display (dBm) is enabled when  is pressed.	AC voltage measurement (AC mV)
	AC+DC voltage measurement (AC+DC mV)	AC coupling frequency measurement (Hz)
		AC voltage measurement (AC mV)
		DC voltage measurement (DC mV)
AC+DC voltage decibel display (dBm) is enabled when  is pressed.	AC+DC voltage measurement (AC+DC V)	
	Resistance measurement (Ω)	Ambient temperature (°C) <sup>[b]</sup>
	Continuity test (••) Ω	Press  to switch between the normal open or normal closed state.
	Resistance measurement (Ω) with offset compensation (Smart Ω)	Press  to switch between the leakage current and bias voltage display.
	Diode test (V)	Ambient temperature (°C) <sup>[b]</sup>
	Auto-diode test (V)	
	Capacitance measurement (F)	Ambient temperature (°C) <sup>[b]</sup>
	Temperature measurement (°C or °F)	Ambient temperature (°C) <sup>[c]</sup>



**Table B-1** U1273A/U1273AX dual display combinations (continued)

Rotary switch position	Function shown (when  is pressed) in the:	
	Primary display	Secondary display
 With the positive probe inserted into the <b><math>\mu\text{A}</math></b> <b><math>\text{mA}</math></b> terminal	DC current measurement (DC mA)	DC coupling frequency measurement (Hz) AC current measurement (AC mA)
	AC current measurement (AC mA)	AC coupling frequency measurement (Hz) DC current measurement (DC mA)
	AC+DC current measurement (AC+DC mA)	AC coupling frequency measurement (Hz) AC current measurement (AC mA)
	% (0-20 or 4-20) DC mA	DC current measurement (DC mA)
		DC current measurement (DC mA) <sup>[b]</sup>
 With the positive probe <b>A</b> inserted into the terminal	DC current measurement (DC A)	DC coupling frequency measurement (Hz) AC current measurement (AC A)
	AC current measurement (AC A)	AC coupling frequency measurement (Hz) DC current measurement (DC A)
	AC+DC current measurement (AC+DC A)	AC coupling frequency measurement (Hz) AC current measurement (AC A)
	% (0-20 or 4-20) DC A	DC current measurement (DC A)
		DC current measurement (DC A) <sup>[b]</sup>
	DC current measurement (DC $\mu\text{A}$ )	DC coupling frequency measurement (Hz) AC current measurement (AC $\mu\text{A}$ )
	AC current measurement (AC $\mu\text{A}$ )	AC coupling frequency measurement (Hz) DC current measurement (DC $\mu\text{A}$ )
	AC+DC current measurement (AC+DC $\mu\text{A}$ )	AC coupling frequency measurement (Hz) AC current measurement (AC $\mu\text{A}$ )
		DC current measurement (DC $\mu\text{A}$ )
		DC current measurement (DC $\mu\text{A}$ )

[a] In this measurement mode, the  icon will not appear on the screen regardless of voltage.

## B Dual Display Combinations Using the Dual Key

[b] Alternative dual display combination not available for this function.

[c] When  is pressed, temperature measurement without ambient compensation () is enabled.





This information is subject to change without notice. Always refer to the English version at the Keysight website for the latest revision.

© Keysight Technologies 2012-2021  
Edition 11, February 2021

Printed in Malaysia



U1273-90017

[www.keysight.com](http://www.keysight.com)