

HSMF-C16x

Miniature Bi-Color Surface Mount ChipLEDs

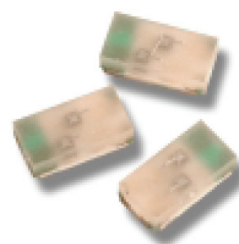

Data Sheet



Description

This series of bi-color ChipLEDs is designed with the smallest footprint to achieve high density of components on board. They have the industry standard footprint of 1.6 mm x 0.8 mm and a height of only 0.5 mm. This makes them very suitable for cellular phone and mobile equipment backlighting and indication. They are available in a wide range of color combinations. In order to facilitate automated pick and place operation, these ChipLEDs are shipped in tape and reel, with 4000 units per reel. These parts are compatible with reflow soldering.

Features

- Small size
- 0603 industry standard footprint
- Diffused optics
- Operating temperature range of -40°C to $+85^{\circ}\text{C}$
- Compatible with reflow soldering
- Available in various color combination
- Available in 8 mm tape on 7" (178 mm) diameter reels

Applications

- Keypad backlighting
- Symbol indicator
- LCD backlighting
- Pushbutton backlighting
- Front panel indicator

Device Selection Guide

| Part Number | Color | Package Description |
|-------------|---------------------------------|---------------------|
| HSMF-C162 | AllnGaP Red / AllnGaP Amber | Untinted, Diffused |
| HSMF-C163 | AllnGaP Red / InGaN Green | Untinted, Diffused |
| HSMF-C164 | AllnGaP Red / InGaN Blue | Untinted, Diffused |
| HSMF-C165 | High Efficiency Red / GaP Green | Untinted, Diffused |
| HSMF-C166 | GaP Yellow / GaP Green | Untinted, Diffused |
| HSMF-C167 | GaP Orange / GaP Green | Untinted, Diffused |
| HSMF-C168 | InGaN Green / InGaN Blue | Untinted, Diffused |
| HSMF-C169 | AllnGaP Amber / InGaN Blue | Untinted, Diffused |

CAUTION: HSMF-C16x LEDs are class 1A ESD sensitive per JESD22-A114C.01 standard. Please observe appropriate precautions during handling and processing. Refer to Avago Technologies Application Note AN-1142 for additional details.

Package Dimensions

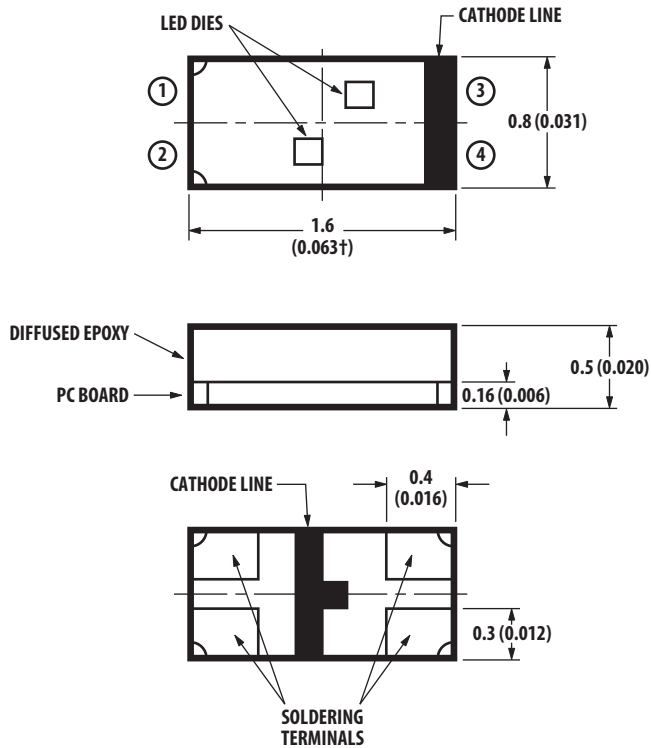

| POLARITY | HSMF-C162 | HSMF-C163 | HSMF-C164 | HSMF-C165 | HSMF-C166 | HSMF-C167 | HSMF-C168 | HSMF-C169 |
|----------|-----------|-----------|-----------|-----------|-----------|-----------|-----------|-----------|
| ① — >— ③ | AMBER | GREEN | BLUE | GREEN | GREEN | GREEN | BLUE | BLUE |
| ② — >— ④ | RED | RED | RED | RED | YELLOW | ORANGE | GREEN | AMBER |

NOTES:

- ALL DIMENSIONS IN MILLIMETERS (INCHES).
- TOLERANCE IS ± 0.1 MM (± 0.004 IN.) UNLESS OTHERWISE SPECIFIED.

Absolute Maximum Ratings for Each Die at $T_A = 25^\circ\text{C}$

| Parameter | AlInGaP | InGaN | GaP | Units |
|-----------------------------------|---|-------|-----|------------------|
| DC Forward Current ^[1] | 20 | 10 | 20 | mA |
| Power Dissipation | 48 | 38 | 52 | mW |
| Reverse Voltage | 5 | 5 | 5 | V |
| LED Junction Temperature | 95 | 95 | 95 | $^\circ\text{C}$ |
| Operating Temperature Range | -40 to +85 | | | $^\circ\text{C}$ |
| Storage Temperature Range | -40 to +85 | | | $^\circ\text{C}$ |
| Soldering Temperature | See reflow soldering profile (Figure 6 & 7) | | | |

Note:

- Derate linearly as shown in Figure 4.

Electrical Characteristics at $T_A = 25^\circ\text{C}$

| Color | | Forward Voltage V_F (Volts) @ I_F ^[1] | | Reverse Breakdown V_R (Volts) @ $I_R = 100\ \mu\text{A}$ | Capacitance C (pF), @ $V_F = 0$, $f = 1\ \text{MHz}$ | Thermal Resistance $R_{\theta_{J-PIN}}$ ($^\circ\text{C}/\text{W}$) |
|------------------------------|-------|---|------|---|---|---|
| | | Typ. | Max. | Min. | Typ. | Typ. |
| AllnGaP Red | 20 mA | 1.9 | 2.4 | 5 | 15 | 300 |
| AllnGaP Amber | 20 mA | 1.9 | 2.4 | 5 | 11 | 300 |
| AllnGaP Red ^[2] | 10 mA | 1.8 | 2.3 | 5 | 15 | 300 |
| AllnGaP Amber ^[2] | 10 mA | 1.8 | 2.3 | 5 | 11 | 300 |
| InGaN Green | 10 mA | 3.4 | 3.8 | 5 | 35 | 500 |
| InGaN Blue | 10 mA | 3.4 | 3.8 | 5 | 35 | 500 |
| HER | 20 mA | 1.95 | 2.6 | 5 | 5 | 325 |
| GaP Orange | 20 mA | 2.2 | 2.6 | 5 | 7 | 325 |
| GaP Yellow | 20 mA | 2.1 | 2.6 | 5 | 6 | 325 |
| GaP Green | 20 mA | 2.2 | 2.6 | 5 | 9 | 325 |

Notes:

1. V_F Tolerance: $\pm 0.1\ \text{V}$.
2. The product testing is based on 20 mA. This is for reference only.

Optical Characteristics at $T_A = 25^\circ\text{C}$

| Color | | Luminous Intensity I_v (mcd) @ I_F ^[1] | | Peak Wavelength λ_{peak} (nm) | Color Dominant Wavelength λ_d ^[2] (nm) | Viewing Angle $2\ \theta_{1/2}$ Degrees ^[3] | Luminous Efficacy η_v (lm/W) |
|------------------------------|-------|--|------|--|--|---|---|
| | | Min. | Typ. | Typ. | Typ. | Typ. | Typ. |
| AllnGaP Red | 20 mA | 28.5 | 90 | 637 | 626 | 120 | 155 |
| AllnGaP Amber | 20 mA | 28.5 | 90 | 595 | 592 | 120 | 480 |
| AllnGaP Red ^[4] | 10 mA | 11.2 | 35 | 637 | 626 | 120 | 155 |
| AllnGaP Amber ^[4] | 10 mA | 11.2 | 35 | 595 | 592 | 120 | 480 |
| InGaN Green | 10 mA | 18 | 45 | 523 | 525 | 120 | 500 |
| InGaN Blue | 10 mA | 2.8 | 10 | 468 | 470 | 120 | 80 |
| HER | 20 mA | 2.8 | 10 | 636 | 621 | 120 | 145 |
| GaP Orange | 20 mA | 2.8 | 8 | 605 | 604 | 120 | 380 |
| GaP Yellow | 20 mA | 2.8 | 8 | 589 | 586 | 120 | 500 |
| GaP Green | 20 mA | 4.5 | 15 | 570 | 572 | 120 | 595 |

Notes:

1. The luminous intensity I_v is measured at the peak of the spatial radiation pattern which may not be aligned with the mechanical axis of the lamp package.
2. The dominant wavelength λ_d is derived from the CIE Chromaticity Diagram and represents the perceived color of the device.
3. $\theta_{1/2}$ is the off-axis angle where the luminous intensity is 1/2 the peak intensity.
4. The product testing is based on 20 mA. This is for reference purpose.

Color Bin Limits^[1]

| Green Color Bins ^[1] | | |
|---------------------------------|-------|-------|
| Dom. Wavelength (nm) | | |
| Bin ID | Min. | Max. |
| A | 561.5 | 564.5 |
| B | 564.5 | 567.5 |
| C | 567.5 | 570.5 |
| D | 570.5 | 573.5 |
| E | 573.5 | 576.5 |

Tolerance: ± 0.5 nm

| Blue Color Bins ^[1] | | |
|--------------------------------|-------|-------|
| Dom. Wavelength (nm) | | |
| Bin ID | Min. | Max. |
| A | 460.0 | 465.0 |
| B | 465.0 | 470.0 |
| C | 470.0 | 475.0 |
| D | 475.0 | 480.0 |

Tolerance: ± 1 nm

| Orange Color Bins ^[1] | | |
|----------------------------------|-------|-------|
| Dom. Wavelength (nm) | | |
| Bin ID | Min. | Max. |
| A | 597.0 | 600.0 |
| B | 600.0 | 603.0 |
| C | 603.0 | 606.0 |
| D | 606.0 | 609.0 |
| E | 609.0 | 612.0 |
| F | 612.0 | 615.0 |

Tolerance: ± 1 nm

Note:

1. Bin categories are established for classification of products. Products may not be available in all categories. Please contact your Avago representative for information on currently available bins.

| Yellow/Amber Color Bins ^[1] | | |
|--|-------|-------|
| Dom. Wavelength (nm) | | |
| Bin ID | Min. | Max. |
| A | 582.0 | 584.5 |
| B | 584.5 | 587.0 |
| C | 587.0 | 589.5 |
| D | 589.5 | 592.0 |
| E | 592.0 | 594.5 |
| F | 594.5 | 597.0 |

Tolerance: ± 0.5 nm

| InGaN Green Color Bins ^[1] | | |
|---------------------------------------|-------|-------|
| Dom. Wavelength (nm) | | |
| Bin ID | Min. | Max. |
| A | 515.0 | 520.0 |
| B | 520.0 | 525.0 |
| C | 525.0 | 530.0 |
| D | 530.0 | 535.0 |

Tolerance: ± 1 nm

Intensity (I_v) Bin Limits^[1]

| Bin ID | Intensity @ 20 mA (mcd) | |
|--------|-------------------------|---------|
| | Min. | Max. |
| A | 0.11 | 0.18 |
| B | 0.18 | 0.29 |
| C | 0.29 | 0.45 |
| D | 0.45 | 0.72 |
| E | 0.72 | 1.10 |
| F | 1.10 | 1.80 |
| G | 1.80 | 2.80 |
| H | 2.80 | 4.50 |
| J | 4.50 | 7.20 |
| K | 7.20 | 11.20 |
| L | 11.20 | 18.00 |
| M | 18.00 | 28.50 |
| N | 28.50 | 45.00 |
| P | 45.00 | 71.50 |
| Q | 71.50 | 112.50 |
| R | 112.50 | 180.00 |
| S | 180.00 | 285.00 |
| T | 285.00 | 450.00 |
| U | 450.00 | 715.00 |
| V | 715.00 | 1125.00 |
| W | 1125.00 | 1800.00 |
| X | 1800.00 | 2850.00 |
| Y | 2850.00 | 4500.00 |

Tolerance: ± 15%.

Note:

1. Bin categories are established for classification of products. Products may not be available in all categories. Please contact your Avago representative for information on currently available bins.

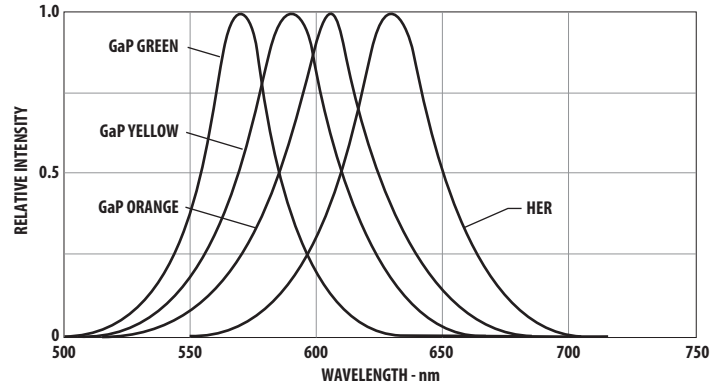
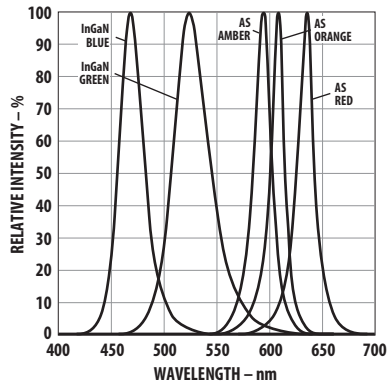

Figure 1. Relative intensity vs. wavelength.

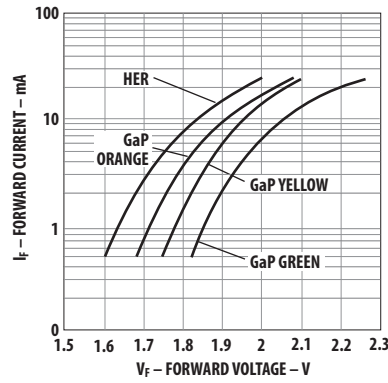
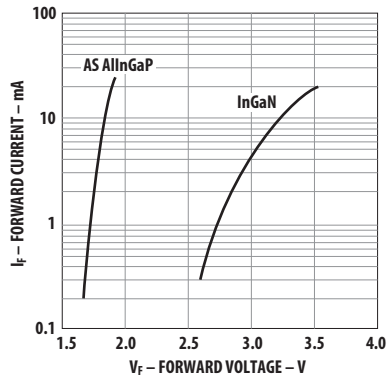

Figure 2. Forward current vs. forward voltage.

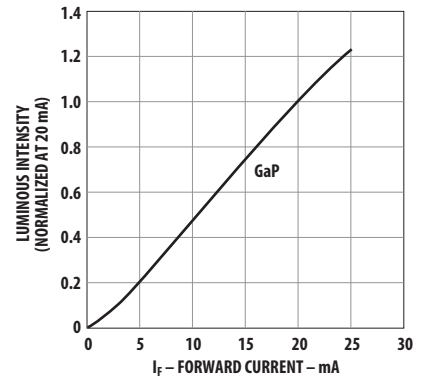
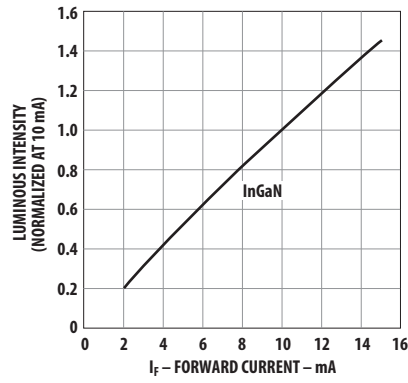
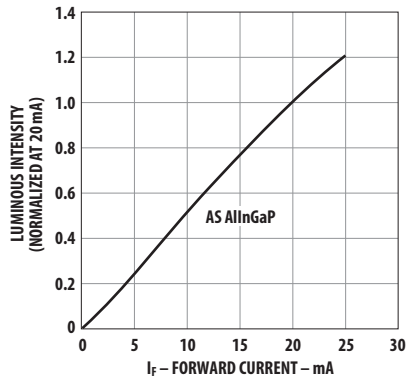

Figure 3. Luminous intensity vs. forward current.

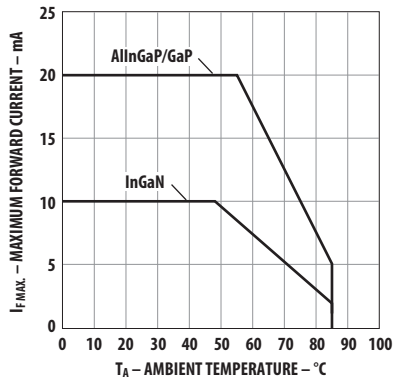

Figure 4. Maximum forward current vs. ambient temperature.

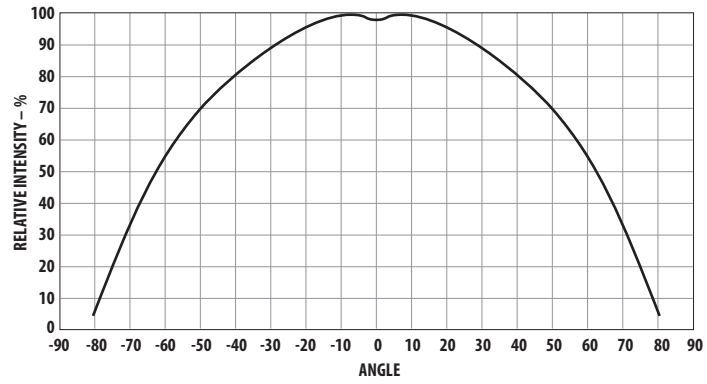

Figure 5. Relative intensity vs. angle.

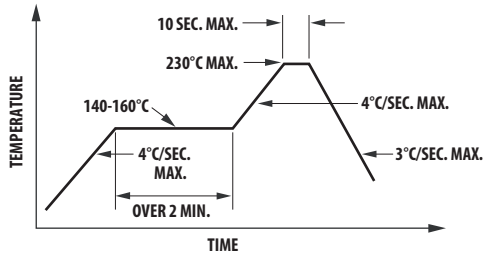
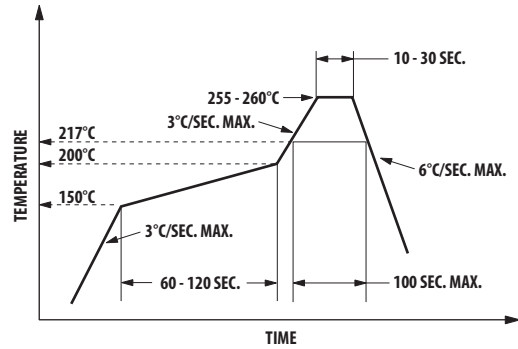

Figure 6. Recommended reflow soldering profile.



(Acc. to J-STD-020C)

Figure 7. Recommended Pb-free reflow soldering profile.

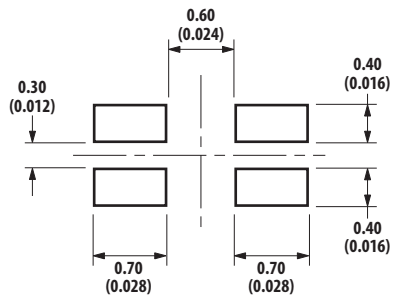

Figure 8. Recommended soldering pad pattern.

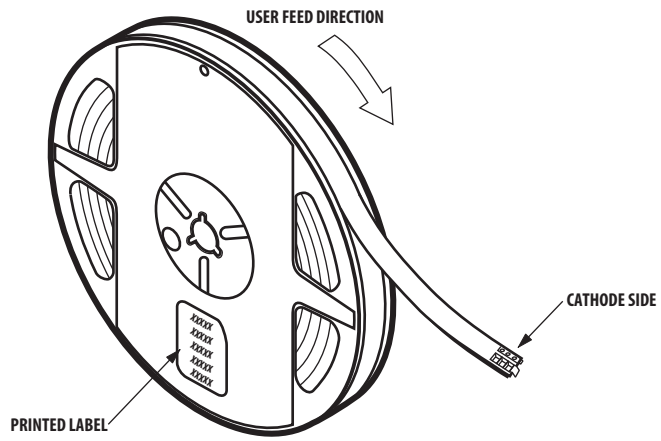
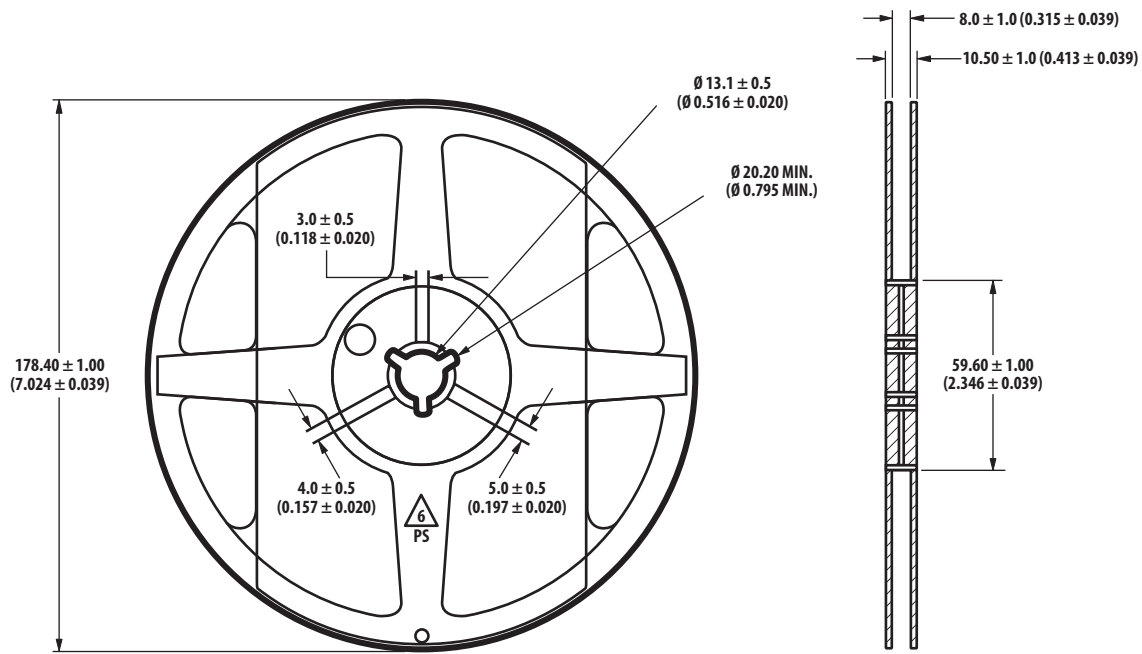

Figure 9. Reeling orientation.



NOTE:
1. ALL DIMENSIONS IN MILLIMETERS (INCHES).

Figure 10. Reel dimensions.

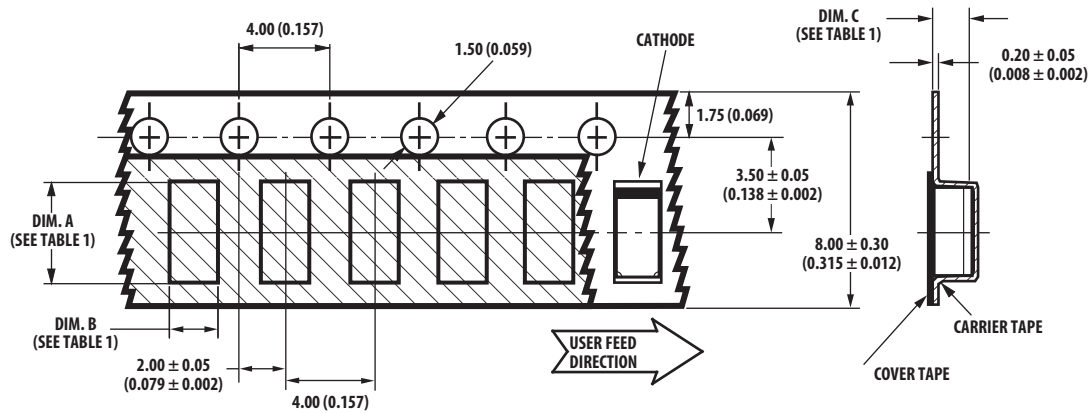
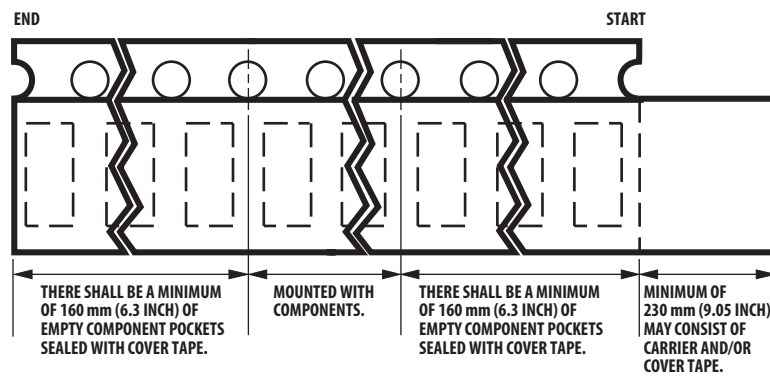

TABLE 1
DIMENSIONS IN MILLIMETERS (INCHES)

| PART NUMBER | DIM. A ± 0.10 (± 0.004) | DIM. B ± 0.10 (± 0.004) | DIM. C ± 0.10 (± 0.004) |
|-------------|----------------------------|----------------------------|----------------------------|
| HSMF-C16x | 1.75 (0.069) | 0.95 (0.037) | 0.60 (0.024) |

Figure 11. Tape dimensions.



NOTES:

1. ALL DIMENSIONS IN MILLIMETERS (INCHES).
2. TOLERANCE IS ± 0.1 MM (± 0.004 IN.) UNLESS OTHERWISE SPECIFIED.

Figure 12. Tape leader and trailer dimensions.

Reflow Soldering

For more information on reflow soldering, refer to Application Note 1060, *Surface Mounting SMT LED Indicator Components*.

Storage Condition:

5 to 30° C @ 60% RH max.

Baking is required under the condition:

- a) the blue silica gel indicator becoming white/transparent color
- b) the pack has been opened for more than 672 hours.

Baking recommended condition: $60 \pm 5^\circ$ C for 20 hours.

For product information and a complete list of distributors, please go to our web site: www.avagotech.com