

MC 1,5/ 3-GF-3,5 - PCB header



1843800

<https://www.phoenixcontact.com/us/products/1843800>

Please be informed that the data shown in this PDF document is generated from our online catalog. Please find the complete data in the user documentation. Our general terms of use for downloads are valid.

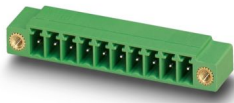

PCB headers, nominal cross section: 1.5 mm², color: green, nominal current: 8 A, rated voltage (III/2): 160 V, contact surface: Tin, contact connection type: Pin, number of potentials: 3, number of rows: 1, number of positions: 3, number of connections: 3, product range: MC 1,5/-GF, pitch: 3.5 mm, mounting: Wave soldering, pin layout: Linear pinning, solder pin [P]: 3.4 mm, number of solder pins per potential: 1, plug-in system: COMBICON MC 1,5, Pin connector pattern alignment: Standard, locking: Screw locking mechanism, mounting: Threaded flange, type of packaging: packed in cardboard

Your advantages

- Well-known mounting principle allows worldwide use
- Screwable flange for superior mechanical stability
- Maximum flexibility when it comes to device design – one header for connectors with different connection technologies

Commercial data

Item number	1843800
Packing unit	250 pc
Minimum order quantity	250 pc
Sales key	AA02
Product key	AABSAB
Catalog page	Page 225 (C-1-2013)
GTIN	4017918112912
Weight per piece (including packing)	1.841 g
Weight per piece (excluding packing)	1.7 g
Customs tariff number	85366930
Country of origin	DE

MC 1,5/ 3-GF-3,5 - PCB header



1843800

<https://www.phoenixcontact.com/us/products/1843800>

Technical data

Product properties

Product type	PCB headers
Product family	MC 1,5/..-GF
Product line	COMBICON Connectors S
Type	Standard
Number of positions	3
Pitch	3.5 mm
Number of connections	3
Number of rows	1
Number of potentials	3
Mounting flange	Threaded flange
Pin layout	Linear pinning
Solder pins per potential	1

Electrical properties

Nominal current I_N	8 A
Nominal voltage U_N	160 V
Degree of pollution	3
Contact resistance	1.3 m Ω
Rated voltage (III/3)	160 V
Rated surge voltage (III/3)	2.5 kV
Rated voltage (III/2)	160 V
Rated surge voltage (III/2)	2.5 kV
Rated voltage (II/2)	250 V
Rated surge voltage (II/2)	2.5 kV

Mounting

Mounting type	Wave soldering
Pin layout	Linear pinning

Flange

Tightening torque	0.3 Nm
-------------------	--------

Material specifications

Material data - contact

Note	WEEE/RoHS-compliant, free of whiskers according to IEC 60068-2-82/JEDEC JESD 201
Contact material	Cu alloy
Surface characteristics	Tin-plated
Metal surface contact area (top layer)	Tin (3 - 5 μm Sn)
Metal surface contact area (middle layer)	Nickel (1.3 - 3 μm Ni)
Metal surface soldering area (top layer)	Tin (3 - 5 μm Sn)

MC 1,5/ 3-GF-3,5 - PCB header

1843800

<https://www.phoenixcontact.com/us/products/1843800>

Metal surface soldering area (middle layer)	Nickel (1.3 - 3 µm Ni)
---	------------------------

Material data - housing

Color (Housing)	green (6021)
Insulating material	PBT
Insulating material group	IIIa
CTI according to IEC 60112	225
Flammability rating according to UL 94	V0

Dimensions

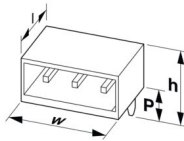
Dimensional drawing	
Pitch	3.5 mm
Width [w]	20.85 mm
Height [h]	10.65 mm
Length [l]	9.2 mm
Installed height	7.25 mm
Solder pin length [P]	3.4 mm
Pin dimensions	0.8 x 0.8 mm

PCB design

Hole diameter	1.2 mm
---------------	--------

Mechanical tests

Visual inspection

Specification	IEC 60512-1-1:2002-02
Result	Test passed

Dimension check

Specification	IEC 60512-1-2:2002-02
Result	Test passed

Resistance of inscriptions

Specification	IEC 60068-2-70:1995-12
Result	Test passed

Polarization and coding

Specification	IEC 60512-13-5:2006-02
Result	Test passed

Contact holder in insert

Specification	IEC 60512-15-1:2008-05
---------------	------------------------

MC 1,5/ 3-GF-3,5 - PCB header



1843800

<https://www.phoenixcontact.com/us/products/1843800>

Contact holder in insert Requirements >20 N	Test passed
--	-------------

Insertion and withdrawal forces

Result	Test passed
No. of cycles	25
Insertion strength per pos. approx.	6 N
Withdraw strength per pos. approx.	4 N

Electrical tests

Thermal test | Test group C

Specification	IEC 60512-5-1:2002-02
Tested number of positions	20

Insulation resistance

Specification	IEC 60512-3-1:2002-02
Insulation resistance, neighboring positions	> 5 MΩ

Air clearances and creepage distances |

Specification	IEC 60664-1:2007-04
Insulating material group	IIIa
Comparative tracking index (IEC 60112)	CTI 225
Rated insulation voltage (III/3)	160 V
Rated surge voltage (III/3)	2.5 kV
minimum clearance value - non-homogenous field (III/3)	1.5 mm
minimum creepage distance (III/3)	2.5 mm
Rated insulation voltage (III/2)	160 V
Rated surge voltage (III/2)	2.5 kV
minimum clearance value - non-homogenous field (III/2)	1.5 mm
minimum creepage distance (III/2)	1.6 mm
Rated insulation voltage (II/2)	250 V
Rated surge voltage (II/2)	2.5 kV
minimum clearance value - non-homogenous field (II/2)	1.5 mm
minimum creepage distance (II/2)	2.5 mm

Environmental and real-life conditions

Vibration test

Specification	IEC 60068-2-6:2007-12
Frequency	10 - 150 - 10 Hz
Sweep speed	1 octave/min
Amplitude	0.35 mm (10 Hz ... 60.1 Hz)
Acceleration	5g (60.1 Hz ... 150 Hz)
Test duration per axis	2.5 h

Durability test

MC 1,5/ 3-GF-3,5 - PCB header



1843800

<https://www.phoenixcontact.com/us/products/1843800>

Specification	IEC 60512-9-1:2010-03
Impulse withstand voltage at sea level	2.95 kV
Contact resistance R ₁	1.3 mΩ
Contact resistance R ₂	1.4 mΩ
Insertion/withdrawal cycles	25
Insulation resistance, neighboring positions	> 5 MΩ

Climatic test

Specification	ISO 6988:1985-02
Corrosive stress	0.2 dm ³ SO ₂ on 300 dm ³ /40 °C/1 cycle
Thermal stress	100 °C/168 h
Power-frequency withstand voltage	1.39 kV

Shocks

Specification	IEC 60068-2-27:2008-02
Pulse shape	Semi-sinusoidal
Acceleration	30g
Shock duration	18 ms
Test directions	X-, Y- and Z-axis (pos. and neg.)

Ambient conditions

Ambient temperature (operation)	-40 °C ... 100 °C (dependent on the derating curve)
Ambient temperature (storage/transport)	-40 °C ... 70 °C
Relative humidity (storage/transport)	30 % ... 70 %
Ambient temperature (assembly)	-5 °C ... 100 °C

Packaging specifications

Type of packaging	packed in cardboard
-------------------	---------------------

MC 1,5/ 3-GF-3,5 - PCB header

1843800

<https://www.phoenixcontact.com/us/products/1843800>

Drawings

Dimensional drawing

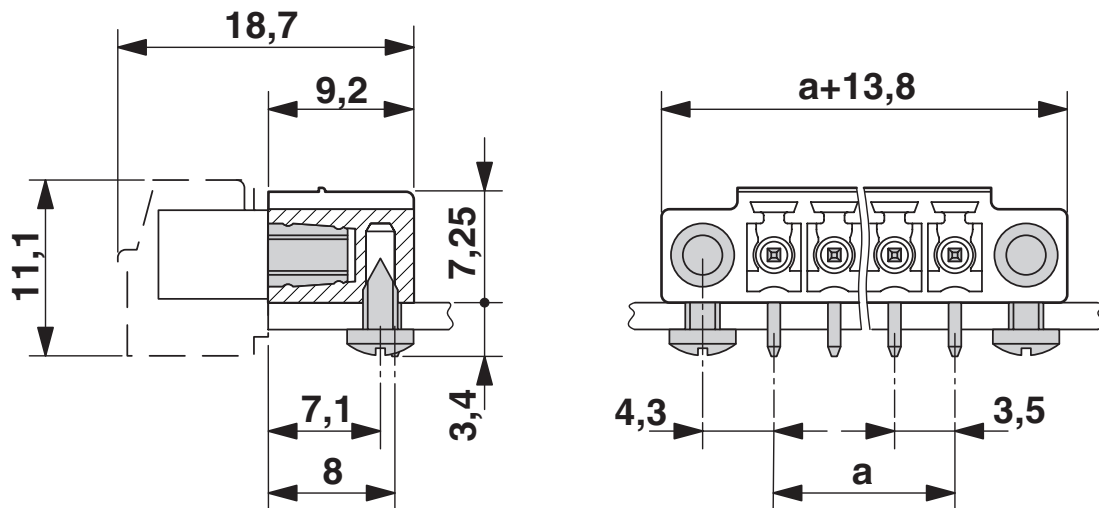

Drilling plan/solder pad geometry

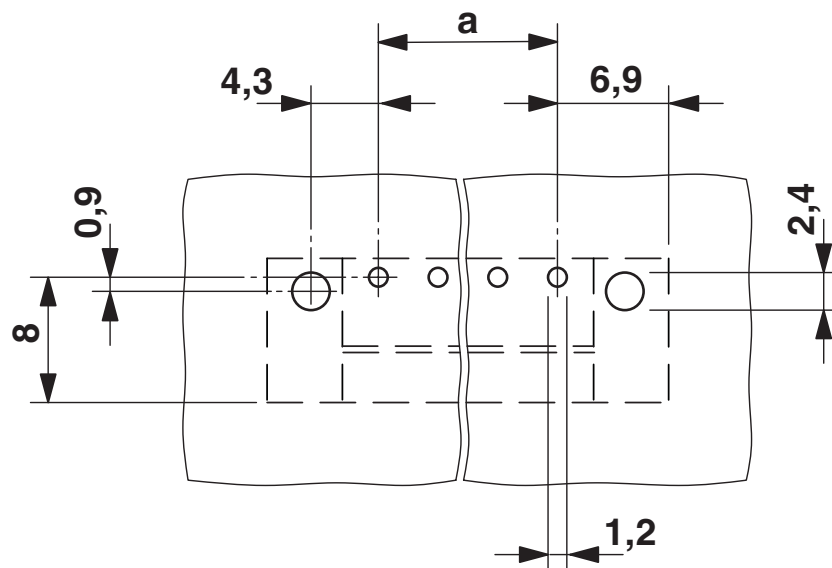

MC 1,5/ 3-GF-3,5 - PCB header

1843800

<https://www.phoenixcontact.com/us/products/1843800>

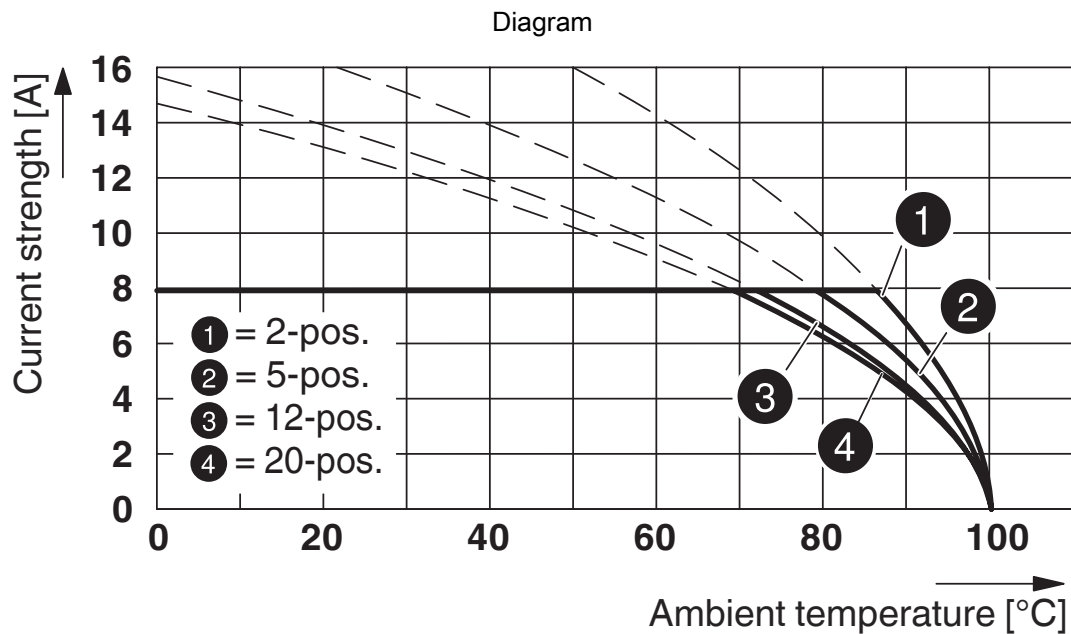

Type: MC 1,5/...-STF-3,5 with MC 1,5/...-GF-3,5

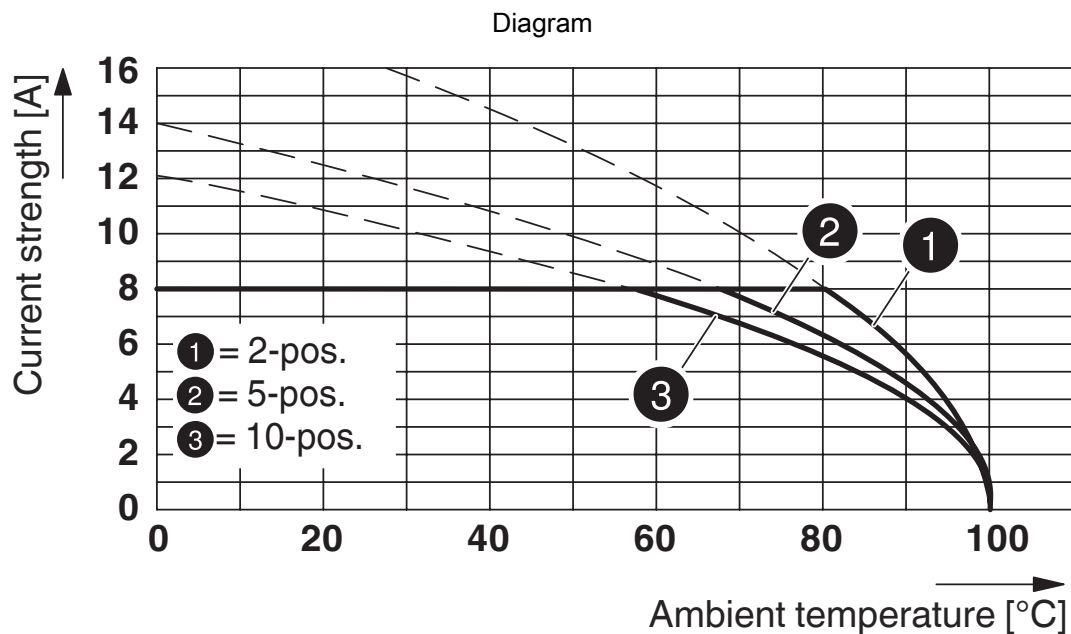

Type: TFMC 1,5/...-STF-3,5 with MC 1,5/...-GF-3,5

MC 1,5/ 3-GF-3,5 - PCB header



1843800

<https://www.phoenixcontact.com/us/products/1843800>

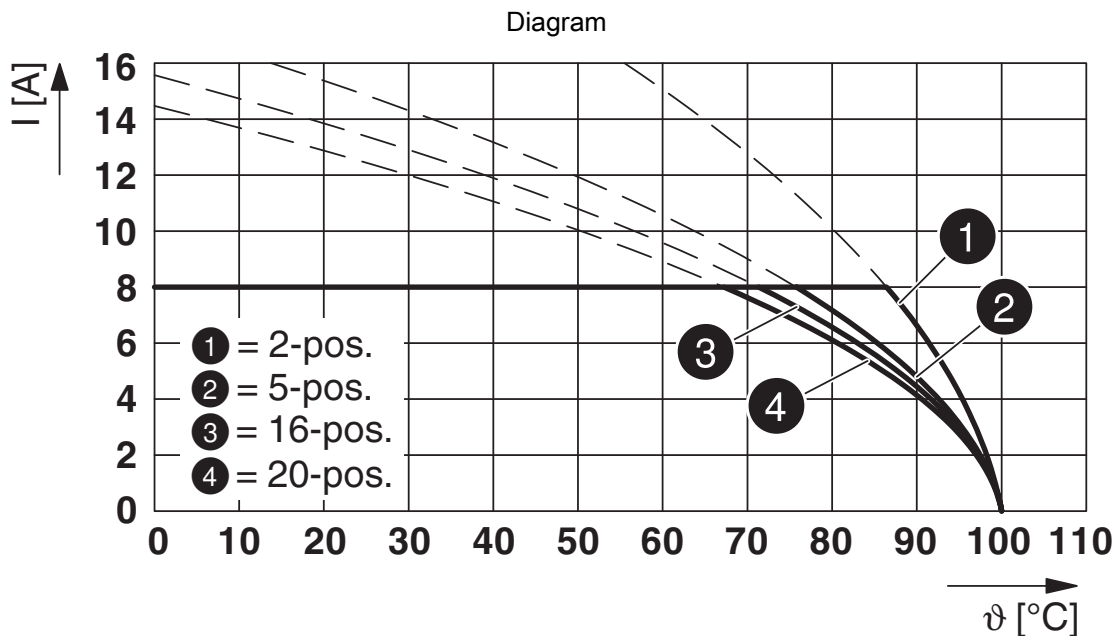

Type: FMC 1,5/...-STF-3,5 with MC 1,5/...-GF-3,5

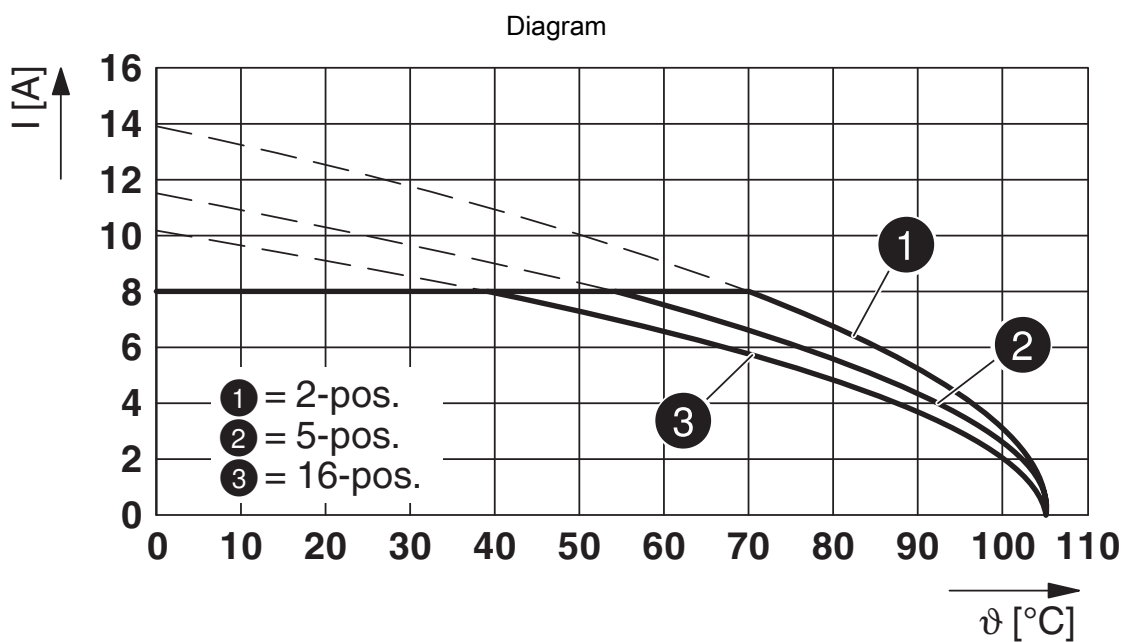

Type: MCVR 1,5/...-STF-3,5 with MC 1,5/...-GF-3,5

MC 1,5/ 3-GF-3,5 - PCB header



1843800

<https://www.phoenixcontact.com/us/products/1843800>

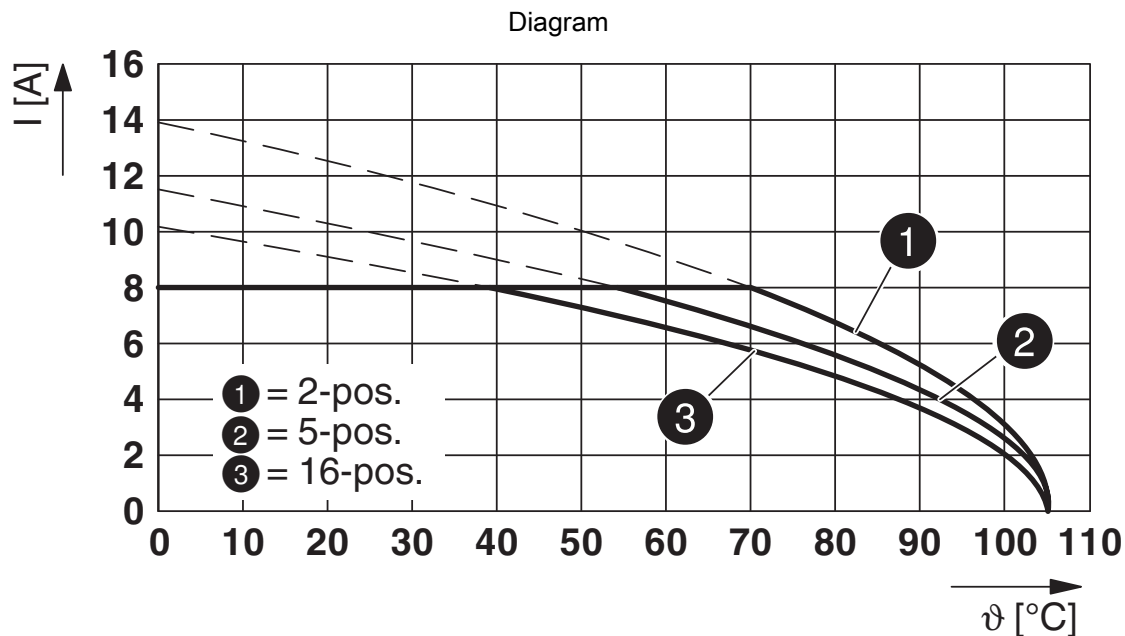

Type: MCVW 1,5/...-STF-3,5 with MC 1,5/...-GF-3,5

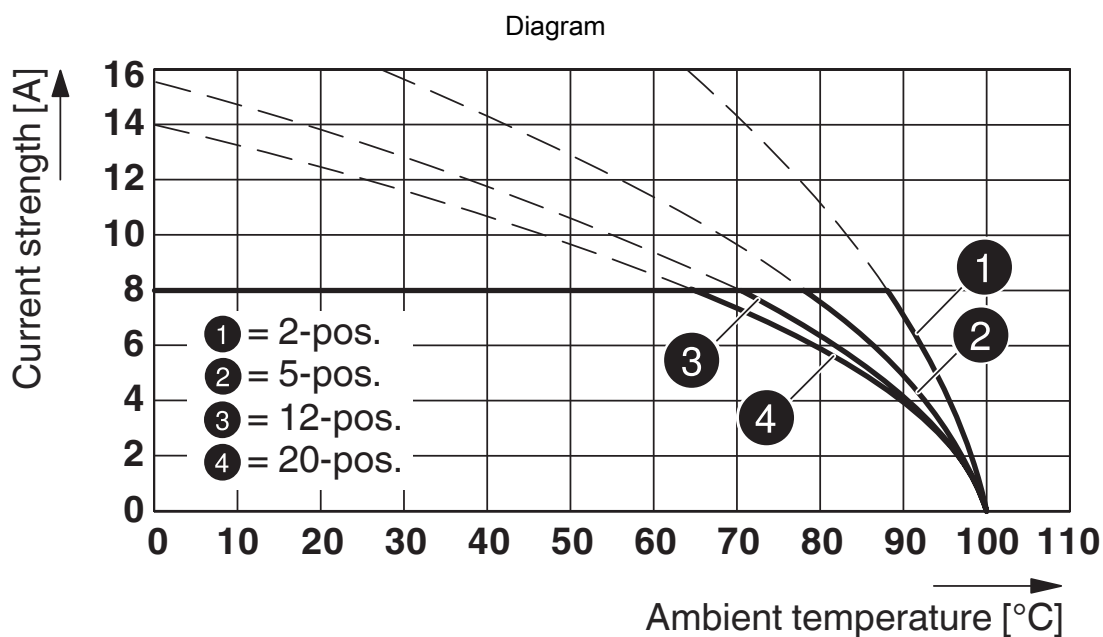

Type: FK-MCP 1,5/...-STF-3,5 with MC 1,5/...-GF-3,5

MC 1,5/ 3-GF-3,5 - PCB header





1843800

<https://www.phoenixcontact.com/us/products/1843800>

Approvals

To download certificates, visit the product detail page: <https://www.phoenixcontact.com/us/products/1843800>

 VDE Zeichengenehmigung Approval ID: 40057836				
	Nominal voltage U_N	Nominal current I_N	Cross section AWG	Cross section mm^2
	160 V	8 A	-	-

 CSA Approval ID: 13631				
	Nominal voltage U_N	Nominal current I_N	Cross section AWG	Cross section mm^2
Use group B	300 V	8 A	-	-
Use group D	300 V	8 A	-	-

 cULus Recognized Approval ID: E60425-20110128				
	Nominal voltage U_N	Nominal current I_N	Cross section AWG	Cross section mm^2
Use group B	300 V	8 A	-	-
Use group D	300 V	8 A	-	-

 VDE Zeichengenehmigung Approval ID: 40011723				
	Nominal voltage U_N	Nominal current I_N	Cross section AWG	Cross section mm^2
	160 V	8 A	-	-

MC 1,5/ 3-GF-3,5 - PCB header



1843800

<https://www.phoenixcontact.com/us/products/1843800>

Classifications

ECLASS

ECLASS-11.0	27460201
ECLASS-12.0	27460201
ECLASS-13.0	27460201

ETIM

ETIM 9.0	EC002637
----------	----------

UNSPSC

UNSPSC 21.0	39121400
-------------	----------

MC 1,5/ 3-GF-3,5 - PCB header

1843800

<https://www.phoenixcontact.com/us/products/1843800>



Environmental product compliance

EU RoHS

Fulfills EU RoHS substance requirements	Yes, No exemptions
---	--------------------

China RoHS

Environment friendly use period (EFUP)	EFUP-E
	No hazardous substances above the limits

EU REACH SVHC

REACH candidate substance (CAS No.)	No substance above 0.1 wt%
-------------------------------------	----------------------------

MC 1,5/ 3-GF-3,5 - PCB header

1843800

<https://www.phoenixcontact.com/us/products/1843800>



Accessories

SK 3,5/2,8:FORTL.ZAHLEN - Marker card

0804073

<https://www.phoenixcontact.com/us/products/0804073>



Marker card, Sheet, white, labeled, horizontal: consecutive numbers 1 ... 10, 11 .. 20, etc. up to 91 ... 99, mounting type: adhesive, for terminal block width: 3.5 mm, lettering field size: 3.5 x 2.8 mm, Number of individual labels: 14

CP-MSTB - Coding profile

1734634

<https://www.phoenixcontact.com/us/products/1734634>



Coding profile, is inserted into the slot on the plug or inverted header, red insulating material

MC 1,5/ 3-GF-3,5 - PCB header

1843800

<https://www.phoenixcontact.com/us/products/1843800>



MC 1,5/10-LWL 1,5-3,5 - Fiber optic

1841161

<https://www.phoenixcontact.com/us/products/1841161>

MINI COMBICON fiber optics, 3.5 mm pitch, 10-pos., separable for other numbers of positions (minimum: 2-pos.), inserts into the back of the MC header, color: transparent, dimension a: 1.5 mm



MC 1,5/10-LWL 2,3-3,5 - Fiber optic

1841187

<https://www.phoenixcontact.com/us/products/1841187>

MINI COMBICON fiber optics, 3.5 mm pitch, 10-pos., separable for other numbers of positions (minimum: 2-pos.), inserts into the back of the MC header, color: transparent, dimension a: 2.3 mm



MC 1,5/ 3-GF-3,5 - PCB header

1843800

<https://www.phoenixcontact.com/us/products/1843800>



MC 1,5/10-LWL 4-3,5 - Fiber optic

1841200

<https://www.phoenixcontact.com/us/products/1841200>

MINI COMBICON fiber optics, 3.5 mm pitch, 10-pos., separable for other numbers of positions (minimum: 2-pos.), inserts into the back of the MC header, color: transparent, dimension a: 4 mm



TFMC 1,5/ 3-STF-3,5 - PCB connectors

1772715

<https://www.phoenixcontact.com/us/products/1772715>

PCB connector, nominal cross section: 1.5 mm², color: green, nominal current: 8 A, rated voltage (III/2): 160 V, contact surface: Tin, contact connection type: Socket, number of potentials: 3, number of rows: 1, number of positions: 3, number of connections: 6, product range: TFMC 1,5/...-STF, pitch: 3.5 mm, connection method: Push-in spring connection, conductor/PCB connection direction: 0 °, plug-in system: COMBICON MC 1,5, locking: Screw locking mechanism, mounting: Screw flange, type of packaging: packed in cardboard

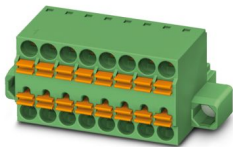

MC 1,5/ 3-GF-3,5 - PCB header

1843800

<https://www.phoenixcontact.com/us/products/1843800>



MC 1,5/ 3-STF-3,5 - PCB connector

1847068

<https://www.phoenixcontact.com/us/products/1847068>

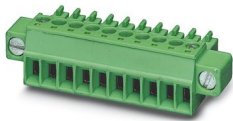

PCB connector, nominal cross section: 1.5 mm², color: green, nominal current: 8 A, rated voltage (III/2): 160 V, contact surface: Tin, contact connection type: Socket, number of potentials: 3, number of rows: 1, number of positions: 3, number of connections: 3, product range: MC 1,5/...-STF, pitch: 3.5 mm, connection method: Screw connection with tension sleeve, screw head form: L Slotted, conductor/PCB connection direction: 0 °, plug-in system: COMBICON MC 1,5, locking: Screw locking mechanism, mounting: Screw flange, type of packaging: packed in cardboard

MCVW 1,5/ 3-STF-3,5 - PCB connector

1863013

<https://www.phoenixcontact.com/us/products/1863013>



PCB connector, nominal cross section: 1.5 mm², color: green, nominal current: 8 A, rated voltage (III/2): 160 V, contact surface: Tin, contact connection type: Socket, number of potentials: 3, number of rows: 1, number of positions: 3, number of connections: 3, product range: MCVW 1,5/...-STF, pitch: 3.5 mm, connection method: Screw connection with tension sleeve, screw head form: L Slotted, conductor/PCB connection direction: -90 °, plug-in system: COMBICON MC 1,5, locking: Screw locking mechanism, mounting: Screw flange, type of packaging: packed in cardboard

MC 1,5/ 3-GF-3,5 - PCB header

1843800

<https://www.phoenixcontact.com/us/products/1843800>



MCVR 1,5/ 3-STF-3,5 - PCB connector

1863314

<https://www.phoenixcontact.com/us/products/1863314>



PCB connector, nominal cross section: 1.5 mm², color: green, nominal current: 8 A, rated voltage (III/2): 160 V, contact surface: Tin, contact connection type: Socket, number of potentials: 3, number of rows: 1, number of positions: 3, number of connections: 3, product range: MCVR 1,5/...-STF, pitch: 3.5 mm, connection method: Screw connection with tension sleeve, screw head form: L Slotted, conductor/PCB connection direction: 90 °, plug-in system: COMBICON MC 1,5, locking: Screw locking mechanism, mounting: Screw flange, type of packaging: packed in cardboard

FK-MCP 1,5/ 3-STF-3,5 - PCB connector

1940101

<https://www.phoenixcontact.com/us/products/1940101>

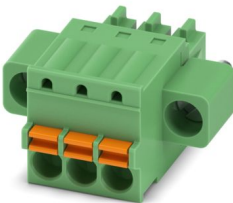

PCB connector, nominal cross section: 1.5 mm², color: green, nominal current: 8 A, rated voltage (III/2): 160 V, contact surface: Tin, contact connection type: Socket, number of potentials: 3, number of rows: 1, number of positions: 3, number of connections: 3, product range: FK-MCP 1,5/...-STF, pitch: 3.5 mm, connection method: Push-in spring connection, conductor/PCB connection direction: 0 °, plug-in system: COMBICON MC 1,5, locking: Screw locking mechanism, mounting: Screw flange, type of packaging: packed in cardboard

MC 1,5/ 3-GF-3,5 - PCB header

1843800

<https://www.phoenixcontact.com/us/products/1843800>



FMC 1,5/ 3-STF-3,5 - PCB connectors

1966101

<https://www.phoenixcontact.com/us/products/1966101>

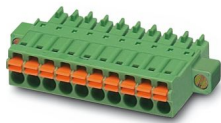

PCB connector, nominal cross section: 1.5 mm², color: green, nominal current: 8 A, rated voltage (III/2): 160 V, contact surface: Tin, contact connection type: Socket, number of potentials: 3, number of rows: 1, number of positions: 3, number of connections: 3, product range: FMC 1,5/..-STF, pitch: 3.5 mm, connection method: Push-in spring connection, conductor/PCB connection direction: 0 °, plug-in system: COMBICON MC 1,5, locking: Screw locking mechanism, mounting: Screw flange, type of packaging: packed in cardboard

Phoenix Contact 2024 © - all rights reserved

<https://www.phoenixcontact.com>

Phoenix Contact USA
586 Fulling Mill Road
Middletown, PA 17057, United States
(+717) 944-1300
info@phoenixcon.com