

FEATURES

Dual-mode inclinometer system

Dual-axis, horizontal operation, $\pm 90^\circ$

Single-axis, vertical operation, $\pm 180^\circ$

High accuracy, 0.1°

Digital inclination data, 0.025° resolution

Digital acceleration data, 0.244 mg resolution

$\pm 1.7 \text{ g}$ accelerometer measurement range

Digital temperature sensor output

Digitally controlled bias calibration

Digitally controlled sample rate

Digitally controlled frequency response

Dual alarm settings with rate/threshold limits

Auxiliary digital I/O

Digitally activated self-test

Digitally activated low power mode

SPI-compatible serial interface

Auxiliary 12-bit ADC input and DAC output

Single-supply operation: 3.0 V to 3.6 V

3500 g powered shock survivability

APPLICATIONS

Platform control, stabilization, and alignment

Tilt sensing, inclinometers, leveling

Motion/position measurement

Monitor/alarm devices (security, medical, safety)

Navigation

GENERAL DESCRIPTION

The **ADIS16209** is a high accuracy, digital inclinometer that accommodates both single-axis ($\pm 180^\circ$) and dual-axis ($\pm 90^\circ$) operation. The standard supply voltage (3.3 V) and serial peripheral interface (SPI) enable simple integration into most industrial system designs. A simple internal register structure handles all output data and configuration features. This includes access to the following output data: calibrated acceleration, accurate incline angles, power supply, internal temperature, auxiliary analog and digital input signals, diagnostic error flags, and programmable alarm conditions.

FUNCTIONAL BLOCK DIAGRAM

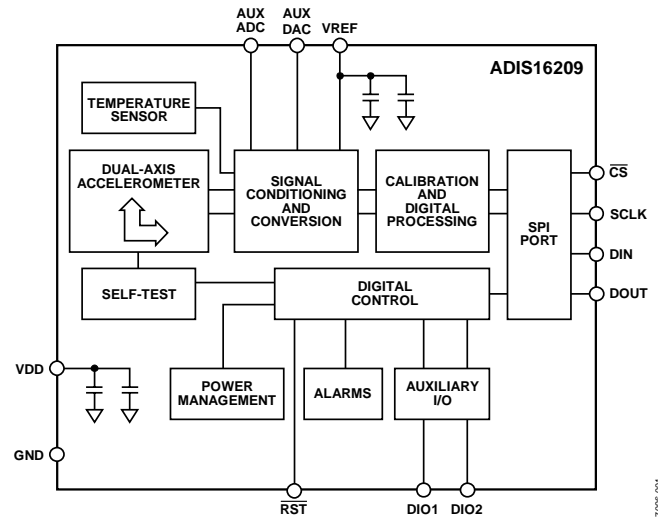

Figure 1.

Configurable operating parameters include sample rate, power management, digital filtering, auxiliary analog and digital output, offset/null adjustment, and self-test for sensor mechanical structure.

The **ADIS16209** is available in a $9.2 \text{ mm} \times 9.2 \text{ mm} \times 3.9 \text{ mm}$ LGA package that operates over a temperature range of -40°C to $+125^\circ\text{C}$. It can be attached using standard RoHS-compliant solder reflow processes.

TABLE OF CONTENTS

Features	1	Introduction	12
Applications	1	Register Structure	12
Functional Block Diagram	1	SPI	12
General Description	1	Reading Sensor Data	12
Revision History	2	Device Configuration	12
Specifications	4	Output Data Registers	15
Timing Specifications	6	Operation Control Registers	17
Timing Diagrams	6	Calibration Registers	20
Absolute Maximum Ratings	7	Alarm Registers	20
Thermal Resistance	7	Applications Information	22
ESD Caution	7	Power Supply Considerations	22
Pin Configuration and Function Descriptions	8	Assembly	22
Recommended Pad Geometry	8	Interface Board	23
Typical Performance Characteristics	9	X-Ray Sensitivity	23
Theory of Operation	11	Outline Dimensions	24
Basic Operation	12	Ordering Guide	24

REVISION HISTORY

3/2019—Rev. G to Rev. H

Added Endnote 1, Table 1; Renumbered Sequentially	5
Deleted Figure 20; Renumbered Sequentially	11
Changes to Basic Operation Section	12
Added Introduction Section, Register Structure Section, Figure 20, SPI Section, Figure 21, Reading Sensor Data Section, Figure 22, Figure 23, and Device Configuration Section	12
Added Table 6 and Table 7; Renumbered Sequentially	12
Added Figure 24, Memory Structure Section, Figure 25, and Figure 26	13
Moved Table 8	14
Changes to Global Commands Section	19
Change to the Power Supply Considerations Section	22
Added X-Ray Sensitivity Section	23
Changes to Ordering Guide	24

8/2018—Rev. F to Rev. G

Change to Note 5, Table 1	4
Changes to Accelerometers Section	12
Change to Digital Filtering Section	14
Changes to Global Commands Section	16
Changes to Assembly Section	19
Added Figure 23; Renumbered Sequentially	19

5/2017—Rev. E to Rev. F

Changes to Figure 3 and Figure 4	5
Change to Basic Operation Section	11

1/2015—Rev. D to Rev. E

Changes to Power Supply Considerations Section and Assembly Section	19
Deleted VDD Ramp Rate Requirements Section and Transient Current Demand from ADIS16209 Section	19
Added Power-On Reset Function Section	19
Changes to Figure 23	20

6/2014—Rev. C to Rev. D

Changes to Table 2	5
Changes to Table 26 and Self-Test Section	15
Changes to Status Section	18
Added Power Supply Considerations Section	19

7/2012—Rev. B to Rev. C

Changes to Endnote 5 in Table 1	4
Changed Digital Input/Output Voltage to GND Maximum Rating from 5.5 V to 5.3 V	6
Added 0x40 to 0x49 and 0x4A Addresses to Table 6	11
Changes to Output Data Registers Section	12
Changes to Digital Filtering Section	14
Changes to Self-Test Section	15
Added Applications Information Section	18
Updated Outline Dimensions	19

8/2009—Rev. A to Rev. B

Changes to Features Section 1
Changes to Input Low Voltage, VINL, Parameter, Table 1 4
Changes to Figure 18 and Figure 19 10
Changes to Table 7, Table 8, and Table 10 12
Updated Outline Dimensions 16
Changes to Ordering Guide 16

7/2008—Rev. 0 to Rev. A

Changes to Figure 19 10
Changes to Table 21 15

3/2008—Revision 0: Initial Version

SPECIFICATIONS

T_A = 25°C, VDD = 3.3 V, tilt = 0°, unless otherwise noted.

Table 1.

Parameter	Test Conditions	Min	Typ	Max	Unit
HORIZONTAL INCLINE	Each axis				
Input Range			±90		Degrees
Relative Accuracy ¹	±30° from horizon, AVG_CNT = 0x08		±0.1		Degrees
Sensitivity	±30° from horizon		0.025		°/LSB
VERTICAL ROTATION	Rotational plane within ±30° of vertical				
Input Range		-180		+180	Degrees
Relative Accuracy	360° of rotation		±0.25		Degrees
Sensitivity	-40°C to +85°C		0.025		°/LSB
ACCELEROMETER	Each axis				
Input Range ²	25°C	±1.7			g
Nonlinearity ²	Percentage of full scale		±0.1	±0.2	%
Alignment Error	X sensor to Y sensor		±0.1		Degrees
Cross Axis Sensitivity			±2		%
Sensitivity	-40°C to +85°C, VDD = 3.0 V to 3.6 V	0.243	0.244	0.245	mg/LSB
ACCELEROMETER NOISE PERFORMANCE					
Output Noise	AVG_CNT = 0x00		1.7		mg rms
Noise Density	AVG_CNT = 0x00		0.19		mg/√Hz rms
ACCELEROMETER FREQUENCY RESPONSE					
Sensor Bandwidth			50		Hz
Sensor Resonant Frequency			5.5		kHz
ACCELEROMETER SELF-TEST STATE ³					
Output Change When Active	At 25°C	706	1343	1973	LSB
TEMPERATURE SENSOR					
Output at 25°C			1278		LSB
Scale Factor			-0.47		°C/LSB
ADC INPUT					
Resolution			12		Bits
Integral Nonlinearity (INL)			±2		LSB
Differential Nonlinearity (DNL)			±1		LSB
Offset Error			±4		LSB
Gain Error			±2		LSB
Input Range		0		2.5	V
Input Capacitance	During acquisition		20		pF
ON-CHIP VOLTAGE REFERENCE					
Accuracy	At 25°C	-10		+10	mV
Reference Temperature Coefficient			±40		ppm/°C
Output Impedance			70		Ω
DAC OUTPUT	5 kΩ/100 pF to GND				
Resolution			12		Bits
Relative Accuracy	For Code 101 to Code 4095		4		LSB
Differential Nonlinearity			1		LSB
Offset Error			±5		mV
Gain Error			±0.5		%
Output Range			0 to 2.5		V
Output Impedance			2		Ω
Output Settling Time			10		μs

Parameter	Test Conditions	Min	Typ	Max	Unit
LOGIC INPUTS					
Input High Voltage, V_{INH}		2.0			V
Input Low Voltage, V_{INL}				0.8	V
Logic 1 Input High Current, I_{INH}	$V_{IH} = 3.3\text{ V}$		± 0.2	± 10	μA
Logic 0 Input Low Current, I_{INL}	$V_{IL} = 0\text{ V}$				
All Except $\overline{\text{RST}}$			-40	-60	μA
$\overline{\text{RST}}^4$			-1		mA
Input Capacitance, C_{IN}			10		pF
DIGITAL OUTPUTS					
Output High Voltage, V_{OH}	$I_{SOURCE} = 1.6\text{ mA}$	2.4			V
Output Low Voltage, V_{OL}	$I_{SINK} = 1.6\text{ mA}$			0.4	V
SLEEP TIMER					
Timeout Period ⁵		0.5		128	Seconds
START-UP TIME⁶					
Power-On	Time until data is available				
	Fast mode, $\text{SMPL_PRD} \leq 0x07$		150		ms
	Normal mode, $\text{SMPL_PRD} \geq 0x08$		190		ms
Reset Recovery	Fast mode, $\text{SMPL_PRD} \leq 0x07$		30		ms
	Normal mode, $\text{SMPL_PRD} \geq 0x08$		70		ms
Sleep Mode Recovery			2.5		ms
FLASH MEMORY					
Endurance ⁷		20,000			Cycles
Data Retention ⁸	$T_J = 85^\circ\text{C}$	20			Years
CONVERSION RATE SETTING					
		1.04		2731	SPS
POWER SUPPLY					
Operating Voltage Range		3.0	3.3	3.6	V
Power Supply Current	Normal mode, $\text{SMPL_PRD} \geq 0x08$		11	14	mA
	Fast mode, $\text{SMPL_PRD} \leq 0x07$		36	42	mA
	Sleep mode, -40°C to $+85^\circ\text{C}$		140	350	μA

¹ X-ray exposure may degrade this performance metric.

² Guaranteed by iMEMS® packaged part testing, design, and/or characterization.

³ Self-test response changes as the square of VDD.

⁴ The $\overline{\text{RST}}$ pin has an internal pull-up.

⁵ Guaranteed by design.

⁶ The times presented in this section represent the time it takes to start producing data in the output registers, after the minimum VDD reaches 3.0 V. They do not represent the settling time of the internal filters.

Note that for the default SENS_AVG and AVG_CNT settings, the typical settling time is ~1.28 seconds. For faster settling times, reduce the AVG_CNT and SMPL_PRD settings. Note that the trade-off associated with faster settling times is noise and power.

⁷ Endurance is qualified as per JEDEC Standard 22 Method A117 and measured at -40°C , $+25^\circ\text{C}$, $+85^\circ\text{C}$, and $+125^\circ\text{C}$.

⁸ Retention lifetime equivalent at junction temperature (T_J) 55°C as per JEDEC Standard 22 Method A117. Retention lifetime decreases with junction temperature.

TIMING SPECIFICATIONS

T_A = 25°C, VDD = 3.3 V, tilt = 0°, unless otherwise noted.

Table 2.

Parameter	Description	Min ¹	Typ	Max	Unit
f _{SCLK}	Fast mode, SMPL_PRD ≤ 0x07 (f _s ≥ 546 Hz) ²	0.01		2.5	MHz
	Normal mode, SMPL_PRD ≥ 0x08 (f _s ≤ 482 Hz) ²	0.01		1.0	MHz
t _{DATARATE}	Chip select period, fast mode, SMPL_PRD ≤ 0x07 (f _s ≥ 546 Hz) ²	32			μs
	Chip select period, normal mode, SMPL_PRD ≥ 0x08 (f _s ≤ 482 Hz) ²	42			μs
t _{STALL}	Chip select period, fast mode, SMPL_PRD ≤ 0x07 (f _s ≥ 546 Hz) ²	10			μs
	Chip select period, normal mode, SMPL_PRD ≥ 0x08 (f _s ≤ 482 Hz) ²	12			μs
t _{CS}	Chip select to clock edge	48.8			ns
t _{DAV}	Data output valid after SCLK edge			100	ns
t _{DSU}	Data input setup time before SCLK rising edge	24.4			ns
t _{DHD}	Data input hold time after SCLK rising edge	48.8			ns
t _{DF}	Data output fall time		5	12.5	ns
t _{DR}	Data output rise time		5	12.5	ns
t _{SFS}	\overline{CS} high after SCLK edge	5			ns

¹ Guaranteed by design, not tested.

² Note that f_s means internal sample rate.

TIMING DIAGRAMS

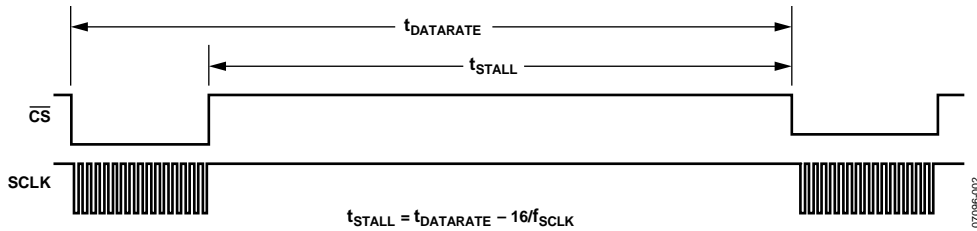

Figure 2. SPI Chip Select Timing

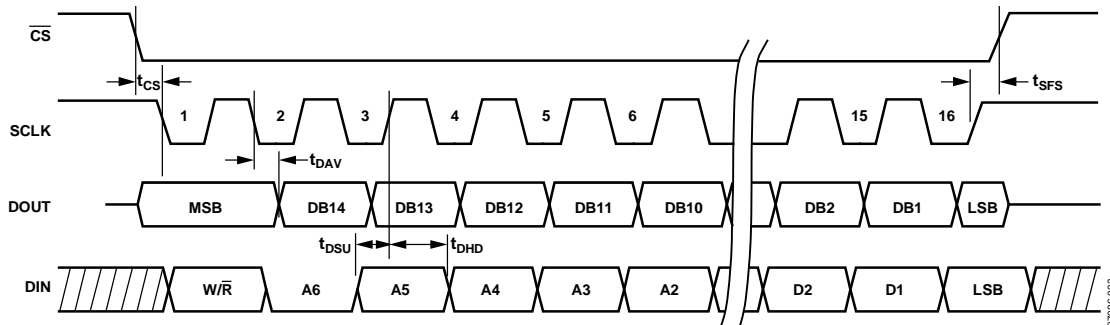

Figure 3. SPI Timing
(Utilizing SPI Settings Typically Identified as Phase = 1, Polarity = 1)

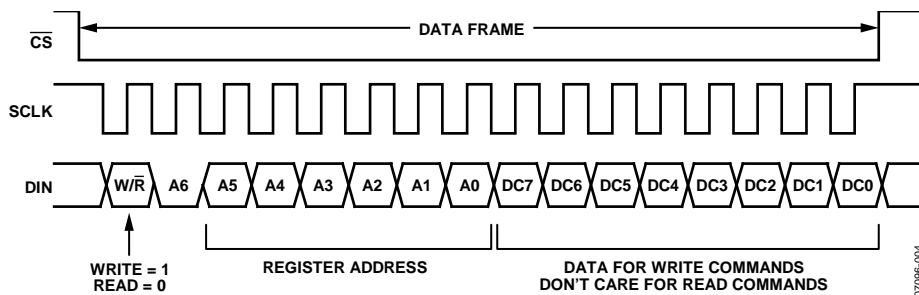

Figure 4. DIN Bit Sequence

ABSOLUTE MAXIMUM RATINGS

Table 3.

Parameter	Rating
Acceleration (Any Axis, Unpowered)	3500 g
Acceleration (Any Axis, Powered)	3500 g
VDD to GND	-0.3 V to +7.0 V
Digital Input/Output Voltage to GND	-0.3 V to +5.3 V
Analog Inputs to GND	-0.3 to VDD + 0.3 V
Analog Inputs to GND	-0.3 to VDD + 0.3 V
Operating Temperature Range	-40°C to +125°C
Storage Temperature Range	-65°C to +150°C

Stresses at or above those listed under Absolute Maximum Ratings may cause permanent damage to the product. This is a stress rating only; functional operation of the product at these or any other conditions above those indicated in the operational section of this specification is not implied. Operation beyond the maximum operating conditions for extended periods may affect product reliability.

THERMAL RESISTANCE

Table 4. Package Characteristics

Package Type	θ_{JA}	θ_{JC}	Device Weight
16-Terminal LGA	250°C/W	25°C/W	0.6 g

ESD CAUTION



ESD (electrostatic discharge) sensitive device. Charged devices and circuit boards can discharge without detection. Although this product features patented or proprietary protection circuitry, damage may occur on devices subjected to high energy ESD. Therefore, proper ESD precautions should be taken to avoid performance degradation or loss of functionality.

PIN CONFIGURATION AND FUNCTION DESCRIPTIONS

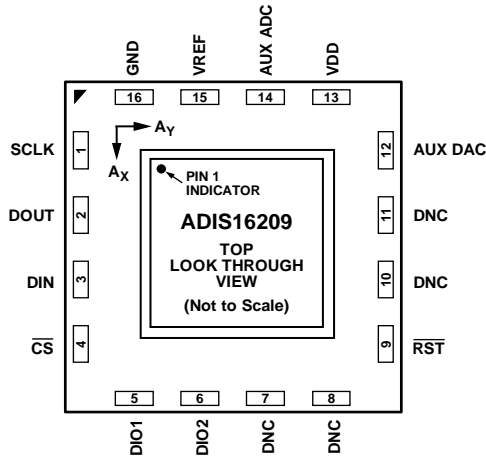

- NOTES**
1. DNC = DO NOT CONNECT TO THIS PIN.
 2. THIS IS NOT AN ACTUAL TOP VIEW, BECAUSE THE PINS ARE NOT VISIBLE FROM THE TOP. THIS IS A LAYOUT VIEW THAT REPRESENTS THE PIN CONFIGURATION IF THE PACKAGE IS LOOKED THROUGH FROM THE TOP. THIS CONFIGURATION IS PROVIDED FOR PCB LAYOUT PURPOSES.

077096-005

Figure 5. Pin Configuration

Table 5. Pin Function Descriptions

Pin No.	Mnemonic	Type ¹	Description
1	SCLK	I	SPI, Serial Clock.
2	DOUT	O	SPI, Data Output.
3	DIN	I	SPI, Data Input.
4	\overline{CS}	I	SPI, Chip Select.
5, 6	DIO1, DIO2	I/O	Digital Input/Output Pins.
7, 8, 10, 11	DNC	N/A	Do not connect to this pin.
9	\overline{RST}	I	Reset, Active Low.
12	AUX DAC	O	Auxiliary DAC Output.
13	VDD	S	Power Supply, 3.3 V.
14	AUX ADC	I	Auxiliary ADC Input.
15	VREF	O	Precision Reference.
16	GND	S	Ground.

¹ S = supply; O = output; I = input.

RECOMMENDED PAD GEOMETRY

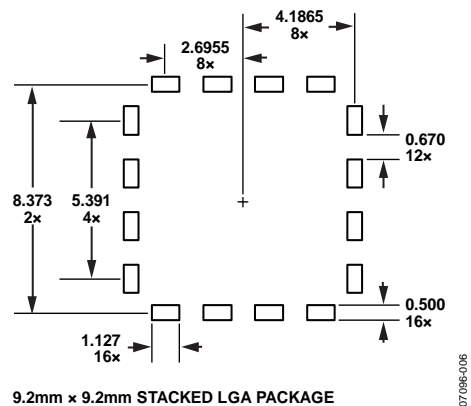

Figure 6. Example of a Pad Layout

077096-006

TYPICAL PERFORMANCE CHARACTERISTICS

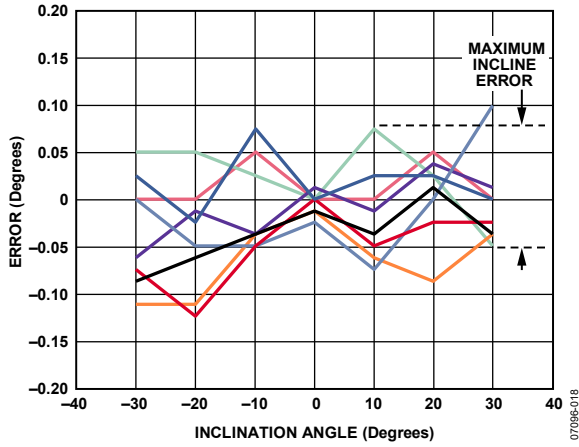

Figure 7. Horizontal Incline Error (Eight Parts), Autonull at Horizontal Position, Stable Temperature, 3.3 V

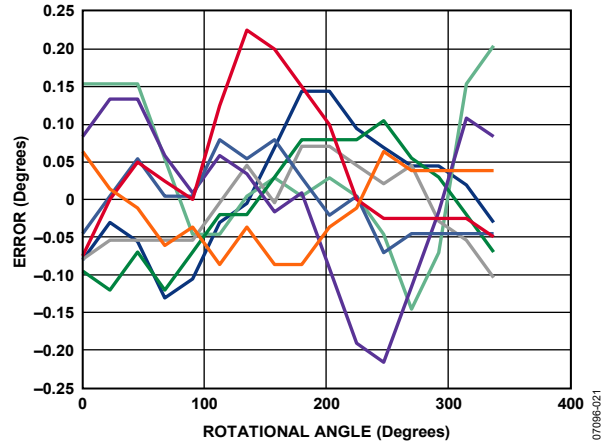

Figure 10. Vertical Mode Rotational Error (Eight Parts), 25°C, 3.3 V

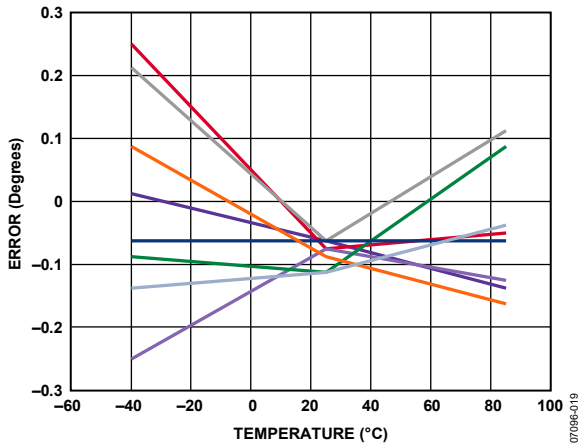

Figure 8. Maximum Incline Error Over a $\pm 30^\circ$ Incline Range (Eight Parts) Over Temperature, Autonull at Horizontal Position, 25°C, 3.3 V

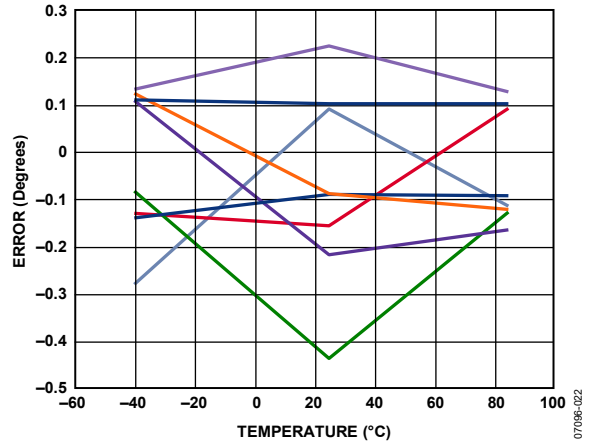

Figure 11. Vertical Mode Error (Eight Parts) vs. Temperature, 0° to 360°, 3.3 V

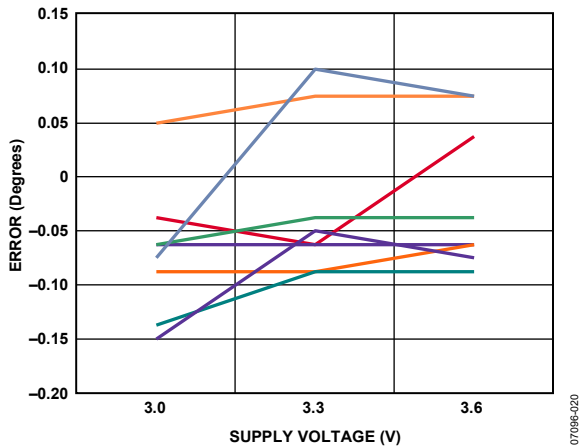

Figure 9. Maximum Incline Error Over a $\pm 30^\circ$ Incline Range (Eight Parts) Over Supply Voltage, Autonull Horizontal Position, 25°C, 3.3 V

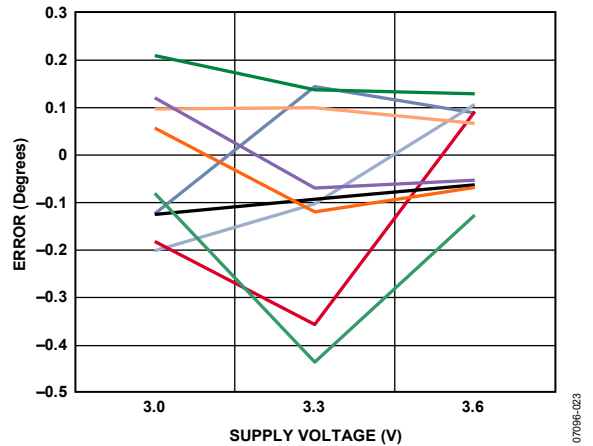

Figure 12. Vertical Mode Error (Eight Parts) vs. Supply Voltage, 0° to 360°, 25°C

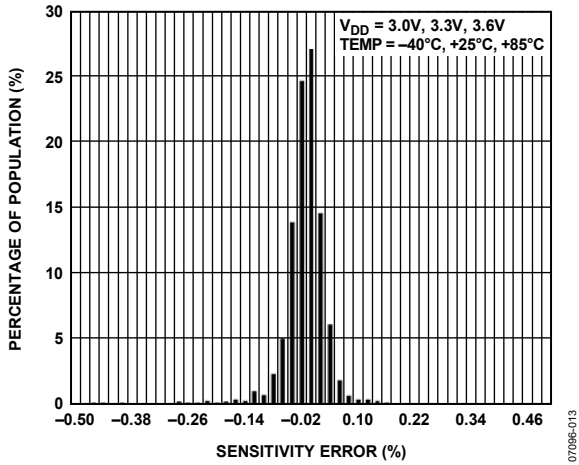

Figure 13. Accelerometer Output Sensitivity Error Distribution

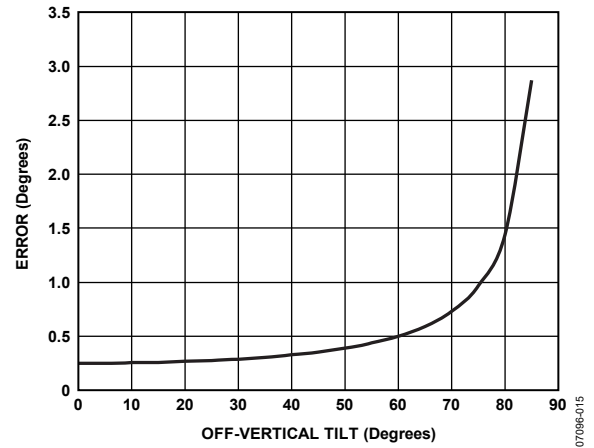

Figure 15. Error vs. Off-Vertical Tilt, 25°C, 3.3 V

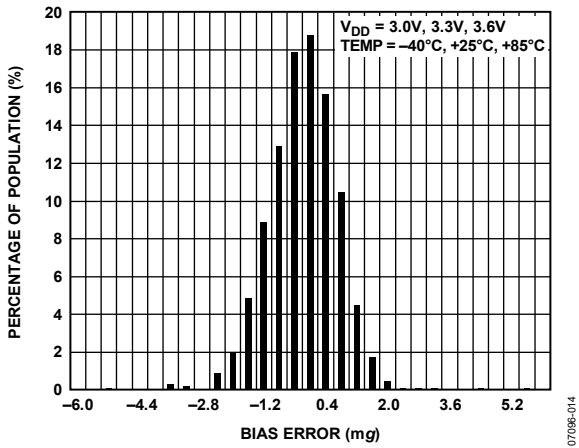

Figure 14. Accelerometer Output Bias Error Distribution

THEORY OF OPERATION

The ADIS16209 tilt sensing system uses gravity as its only stimulus, and a MEMS accelerometer as its sensing element. MEMS accelerometers typically employ a tiny, spring-loaded structure that is interlaced with a fixed pick-off finger structure. The spring constant of the floating structure determines how far it moves when subjected to a force. This structure responds to dynamic forces associated with acceleration and to static forces, such as gravity.

Figure 16 and Figure 17 illustrate how the accelerometer responds to gravity, according to its orientation, with respect to gravity. Figure 16 displays the configuration for the incline angle outputs, and Figure 17 displays the configuration used for the rotational angle position. This configuration provides greater measurement range than a single axis. The ADIS16209 incorporates the signal processing circuit that converts acceleration into an incline angle, and it corrects for several known error sources that would otherwise degrade the accuracy level.

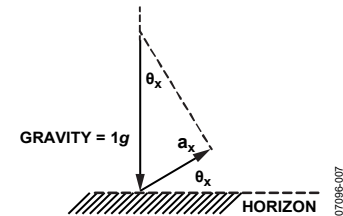

Figure 16. Single-Axis Tilt Theory Diagram

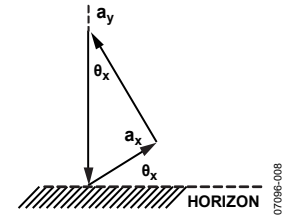

Figure 17. Dual-Axis Tilt Theory Diagram

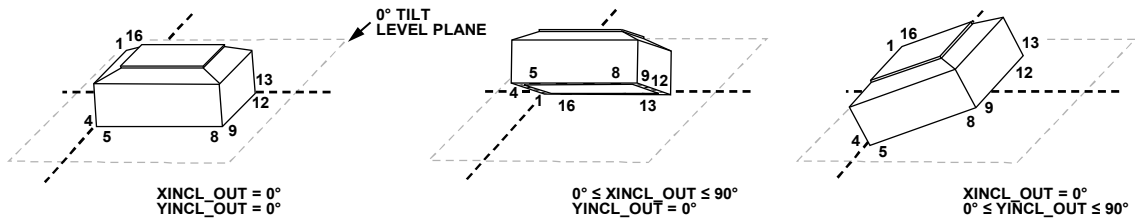
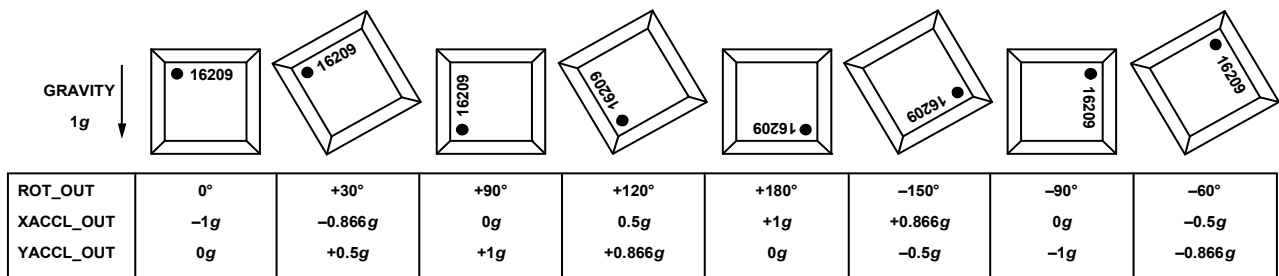

Figure 18. Horizontal Incline Angle Orientation



NOTES

1. ROT_OUT = 180° IS 1 LSB DIFFERENT THAN ROT_OUT = -179.975°.

Figure 19. Vertical Angle Orientation

BASIC OPERATION

INTRODUCTION

When using the factory default configuration for all user configurable control registers, the ADIS16209 initializes itself and automatically starts a continuous process of sampling, processing, and loading calibrated incline angle and acceleration data into the output registers.

REGISTER STRUCTURE

All communication between the ADIS16209 and an external processor involves either reading the contents of an output register or writing configuration (or command) information to a control register (see Figure 20). The output data registers include the latest sensor data, error flags, and identification information. The control registers include sample rate, filtering, calibration, self-test, input/output line operation, and error flags. Each user accessible register has two bytes (upper and lower), each of which has a unique address. See Table 8 for a detailed list of all user registers, along with the corresponding addresses.

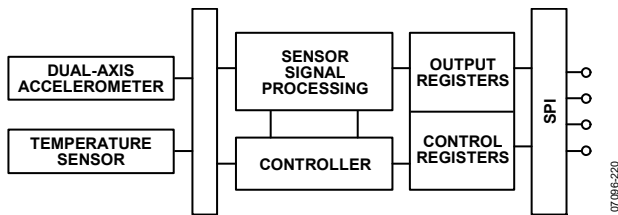

Figure 20. Basic Operation of the ADIS16209

SPI

The SPI provides access to the user registers (see Table 8). Figure 21 shows the most common connections between the ADIS16209 and a SPI master device, which is often an embedded processor that has an SPI-compatible interface.

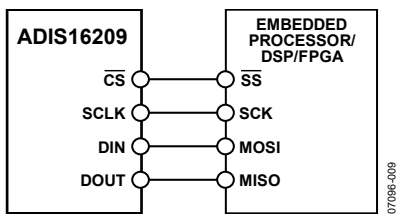

Figure 21. Electrical Connection Diagram

Table 6. Generic SPI Master Pin Mnemonics and Functions

Mnemonic	Function
SS	Slave select
SCLK	Serial clock
MOSI	Master output, slave input
MISO	Master input, slave output

Embedded processors typically use control registers to configure serial ports for communicating with SPI slave devices, such as the ADIS16209. Table 7 provides a list of common settings that describe the SPI protocol of the ADIS16209. The initialization routine of the master processor typically establishes these settings using firmware commands to write them to the control registers.

Table 7. Generic Master Processor SPI Settings

Processor Setting	Description
Master	ADIS16209 operates as slave
SCLK ≤ 2.5 MHz	Maximum serial clock rate SMPL_PRD < 0x08
SCLK ≤ 1 MHz ¹	Maximum serial clock rate SMPL_PRD ≥ 0x08
SPI Mode 3	CPOL = 1 (polarity), CPHA = 1 (phase)
MSB First Mode	Bit sequence, see Figure 26 for coding
16-Bit Mode	Shift register and data length

READING SENSOR DATA

Reading a single register requires two 16-bit cycles on the SPI: one to request the contents of a register and another to receive those contents. The 16-bit command code (see Figure 26) for a read request on the SPI has three parts: the read bit (R/W = 0), either address of the register, [A6:A0], and eight don't care bits, [DC7:DC0]. Figure 22 shows an example that includes two register reads in succession. This example starts with DIN = 0x0C00 to request the contents of the XINCL_OUT register and follows with 0x0E00 to request the contents of the YINCL_OUT register. The sequence in Figure 22 also shows full duplex mode of operation, which means that the ADIS16465 can receive requests on DIN while also transmitting data out on DOUT within the same 16-bit SPI cycle.

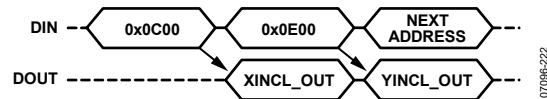

Figure 22. SPI Read Example

Figure 23 shows an example of the four SPI signals when reading the PROD_ID register in a repeating pattern. This pattern can be helpful when troubleshooting the SPI interface setup and communications because the signals are the same for each 16-bit sequence, except during the first cycle.

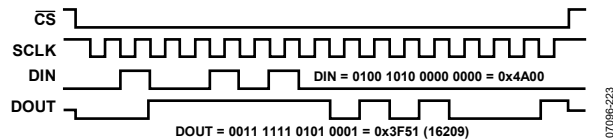

Figure 23. SPI Signal Pattern, Repeating Read of the PROD_ID Register

DEVICE CONFIGURATION

Each configuration register contains 16 bits (two bytes). Bits[7:0] contain the low byte, and Bits[15:8] contain the high byte of each register. Each byte has its own unique address in the user register map (see Table 8). Updating the contents of a register requires writing to both bytes in the following sequence: low byte first, high byte second. The only exception to this requirement is when writing to the COMMAND register. When using this register to trigger a command, only write to the low byte to trigger the command. Writing to the high byte after triggering a command can interrupt the operation, which the low byte triggers.

There are three parts to coding an SPI command (see Figure 26) that write a new byte of data to a register: the write bit ($\bar{R}/W = 1$), the address of the byte, [A6:A0], and the new data for that location, [DC7:DC0]. Figure 24 shows a coding example for writing 0x0001 to the SMPL_PRD register (see Table 24). In Figure 24, the 0xB601 command writes 0x01 to Address 0x36 (lower byte) and the 0xB700 command writes 0x00 to Address 0x37 (upper byte).

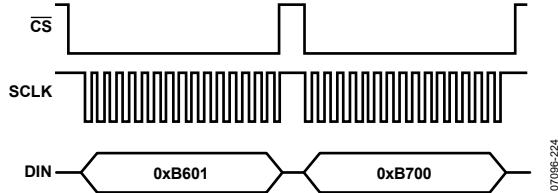

Figure 24. SPI Sequence for Writing 0x0001 to the SMPL_PRD Register

Memory Structure

Figure 25 shows a functional diagram for the memory structure of the ADIS16209. The flash memory bank contains the operational code, unit specific calibration coefficients, and user configuration settings. During initialization (power application or reset recover), this information loads from the flash memory into the static random access memory (SRAM), which supports all normal operation, including register access through the SPI port. Writing to a configuration register using the SPI updates the SRAM location of the register but does not automatically

update the settings in the flash memory bank. The manual flash memory update command (Register COMMAND, Bit 3, see Table 31) provides a convenient method for saving all of these settings to the flash memory bank at one time. A yes in the Flash Backup column of Table 8 identifies the registers that have storage support in the flash memory bank.

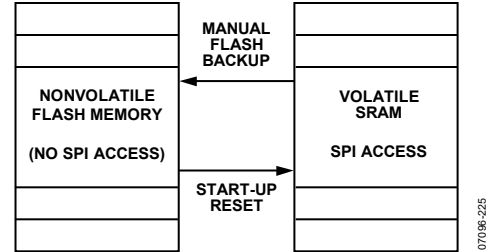
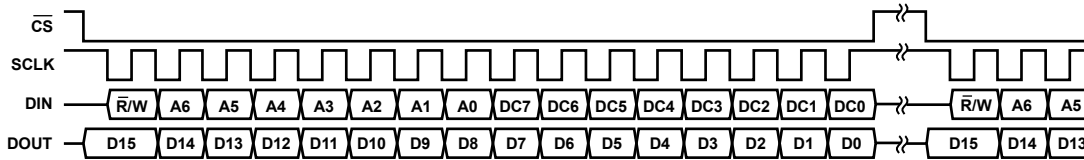

Figure 25. SRAM and Flash Memory Diagram



- NOTES
1. DOUT BITS ARE PRODUCED ONLY WHEN THE PREVIOUS 16-BIT DIN SEQUENCE STARTS WITH $\bar{R}/W = 0$.
 2. WHEN \bar{CS} IS HIGH, DOUT IS IN A THREE-STATE, HIGH IMPEDANCE MODE, WHICH ALLOWS MULTIFUNCTIONAL USE OF THE LINE FOR OTHER DEVICES.

Figure 26. SPI Communication Bit Sequence

Table 8. User Register Map

Name	R/W	Flash Backup	Address	Size (Bytes)	Function	Reference
ENDURANCE	R	Yes	0x00	2	Diagnostics, flash write counter (16-bit binary)	
SUPPLY_OUT	R	No	0x02	2	Output, power supply	Table 20
XACCL_OUT	R	No	0x04	2	Output, x-axis acceleration	Table 10
YACCL_OUT	R	No	0x06	2	Output, y-axis acceleration	Table 11
AUX_ADC	R	No	0x08	2	Output, auxiliary ADC	Table 22
TEMP_OUT	R	No	0x0A	2	Output, temperature	Table 18
XINCL_OUT	R	No	0x0C	2	Output, $\pm 90^\circ$ x-axis inclination	Table 13
YINCL_OUT	R	No	0x0E	2	Output, $\pm 90^\circ$ y-axis inclination	Table 14
ROT_OUT	R	No	0x10	2	Output, $\pm 180^\circ$ vertical rotational position	Table 16
XACCL_NULL	R/W	Yes	0x12	2	Calibration, x-axis acceleration offset null	Table 32
YACCL_NULL	R/W	Yes	0x14	2	Calibration, y-axis acceleration offset null	Table 32
XINCL_NULL	R/W	Yes	0x16	2	Calibration, x-axis inclination offset null	Table 33
YINCL_NULL	R/W	Yes	0x18	2	Calibration, y-axis inclination offset null	Table 33
ROT_NULL	R/W	Yes	0x1A	2	Calibration, vertical rotation offset null	Table 33
			0x1C to 0x1F	4	Reserved, do not write to these locations	
ALM_MAG1	R/W	Yes	0x20	2	Alarm 1, amplitude threshold	Table 34
ALM_MAG2	R/W	Yes	0x22	2	Alarm 2, amplitude threshold	Table 34
ALM_SMPL1	R/W	Yes	0x24	2	Alarm 1, sample period	Table 35
ALM_SMPL2	R/W	Yes	0x26	2	Alarm 2, sample period	Table 35
ALM_CTRL	R/W	Yes	0x28	2	Alarm, source control register	Table 36
		No	0x2A to 0x2F	6	Reserved	
AUX_DAC	R/W	No	0x30	2	Auxiliary DAC data	Table 30
GPIO_CTRL	R/W	No	0x32	2	Operation, digital I/O configuration and data	Table 29
MSC_CTRL	R/W	No	0x34	2	Operation, data-ready and self-test control	Table 28
SMPL_PRD	R/W	Yes	0x36	2	Operation, sample rate configuration	Table 24
AVG_CNT	R/W	Yes	0x38	2	Operation, filter configuration	Table 26
SLP_CNT	W	Yes	0x3A	2	Operation, sleep mode control	Table 25
STATUS	R	No	0x3C	2	Diagnostics, system status register	Table 37
COMMAND	W	No	0x3E	2	Operation, system command register	Table 31
		No	0x40 to 0x49	10	Reserved	
PROD_ID	R	Yes	0x4A	2	Product identification = 0x3F51	N/A

OUTPUT DATA REGISTERS

Table 9 provides the data configuration for each output data register in the ADIS16209. Starting with the MSB of the upper byte, each output data register has the following bit sequence: new data (ND) flag, error/alarm (EA) flag, followed by 14 data bits. The data bits are LSB justified, and in the case of the 12-bit data formats, the remaining two bits are not used. The ND flag indicates that unread data resides in the output data registers. This flag clears and returns to 0 during an output register read sequence. It returns to 1 after the next internal sample update cycle completes. The EA flag indicates an error condition. The STATUS register contains all of the error flags and provides the ability to investigate the root cause.

Table 9. Output Data Register Formats

Register	Bits	Format	Scale ¹
SUPPLY_OUT	14	Binary, 3.3 V = 0x2A3D	0.30518 mV
XACCL_OUT	14	Twos complement	0.24414 mg
YACCL_OUT	14	Twos complement	0.24414 mg
AUX_ADC	12	Binary, 2 V = 0x0CCC	0.6105 mV
TEMP_OUT	12	Binary, 25°C = 0x04FE	-0.47°C
XINCL_OUT ²	14	Twos complement	0.025°
YINCL_OUT ²	14	Twos complement	0.025°
ROT_OUT ³	14	Twos complement	0.025°

¹ Scale denotes quantity per LSB.

² Range is -90° to +90°.

³ Range is -179.975° to +180°.

Accelerometers

The accelerometers respond to both static (gravity) and dynamic acceleration using the polarity shown in Figure 27.

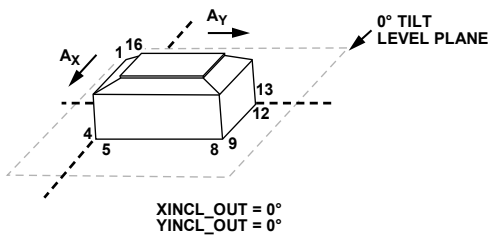

Figure 27. Accelerometer Polarity

07096-024

The XACCL_OUT (see Table 10) and YACCL_OUT (see Table 11) registers provide access to acceleration data for each axis. For example, set DIN = 0x0400 to request data from the x-axis register on the next 16-bit SPI sequence. After reading the contents of one of these registers, mask off the upper two bits, convert the remaining 14-bit, twos complement number into a decimal equivalent, and then multiply that number by 0.024414 to convert the measurement into units of acceleration (mg). Table 12 provides several examples of this data format.

Table 10. XACCL_OUT (Base Address = 0x04), Read Only

Bits	Description
15	New data bit = 1, when register contains un-read data
14	Error/alarm = 1, when STATUS ≠ 0x0000
[13:0]	x-axis accelerometer output data, twos complement, 1 LSB = 0.24414 mg, 0 g = 0x0000

Table 11. YACCL_OUT (Base Address = 0x06), Read Only

Bits	Description
15	New data bit = 1, when register contains un-read data
14	Error/alarm = 1, when STATUS ≠ 0x0000
[13:0]	y-axis accelerometer output data, twos complement, 1 LSB = 0.24414 mg, 0 g = 0x0000

Table 12. Accelerometer Data Format Examples

Acceleration (g)	Decimal	Hex	Binary
+1.7	+6,963	0x1B33	xx01 1011 0011 0011
+1.0	+4,096	0x1000	xx01 0000 0000 0000
+0.00048828	+2	0x0002	xx00 0000 0000 0010
+0.00024414	+1	0x0001	xx00 0000 0000 0001
0	0	0x0000	xx00 0000 0000 0000
-0.00024414	-1	0x3FFF	xx11 1111 1111 1111
-0.00048828	-2	0xFFFE	xx11 1111 1111 1110
-1.0	-4096	0x3000	xx11 0000 0000 0000
-1.7	-27,853	0xE4CD	xx10 0100 1100 1101

Horizontal Incline Angle

The XINCL_OUT (see Table 13) and YINCL_OUT (see Table 14) registers provide access to acceleration data for each axis. For example, set DIN = 0x0400 to request data from the x-axis register on the next 16-bit SPI sequence. After reading the contents of one of these registers, mask off the upper two bits, convert the remaining 14-bit, twos complement number into a decimal equivalent, and then multiply that number by 0.025 to convert the measurement into units of angle (°).

Table 15 provides several examples of this data format.

Table 13. XINCL_OUT (Base Address = 0x0C), Read Only

Bits	Description
15	New data bit = 1, when register contains un-read data
14	Error/alarm = 1, when STATUS ≠ 0x0000
[13:0]	x-axis inclinometer output data, twos complement, 0° = 0x0000, 1 LSB = 0.025°/LSB, ±90° range

Table 14. YINCL_OUT (Base Address = 0x0E), Read Only

Bits	Description
15	New data bit = 1, when register contains un-read data
14	Error/alarm = 1, when STATUS ≠ 0x0000
[13:0]	y-axis inclinometer output data, twos complement, 0° = 0x0000, 1 LSB = 0.025°/LSB, ±90° range

Table 15. Horizontal Incline Angle Data Format Examples

Orientation	Decimal	Hex	Binary
+90° – 0.025°	+3,599	0x0E0F	0000 1110 0000 1111
+0.05°	+2	0x0002	xx00 0000 0000 0010
+0.025°	+1	0x0001	xx00 0000 0000 0001
0°	0	0x0000	xx00 0000 0000 0000
–0.025°	–1	0x3FFF	xx11 1111 1111 1111
–0.05°	–2	0x3FFE	xx11 1111 1111 1110
–90°	–3,600	0x31F1	xx11 0001 1111 0001

Vertical Incline Angle

The ROT_OUT register (see Table 16) provides access to incline angle data for each axis. For example, set DIN = 0x1000 to request data from this register on the next 16-bit SPI sequence. After reading the contents of one of these registers, mask off the upper two bits, convert the remaining 14-bit, twos complement number into a decimal equivalent, and then multiply that number by 0.025 to convert the measurement into units of angle (°). Table 17 provides several examples of this data format.

Table 16. ROT_OUT (Base Address = 0x10), Read Only

Bits	Description
15	New data bit = 1, when register contains un-read data
14	Error/alarm = 1, when STATUS ≠ 0x0000
[13:0]	Vertical inclinometer output data, twos complement, 0° = 0x0000, 1 LSB = 0.025°/LSB, ±180° range

Table 17. Vertical Incline Angle Data Format Examples

Orientation	Decimal	Hex	Binary
+180° – 0.025°	+7,199	0x1C1F	xx01 1100 0001 1111
+0.05°	+2	0x0002	xx00 0000 0000 0010
+0.025°	+1	0x0001	xx00 0000 0000 0001
0°	0	0x0000	xx00 0000 0000 0000
–0.025°	–1	0x3FFF	xx11 1111 1111 1111
–0.05°	–2	0x3FFE	xx11 1111 1111 1110
–180°	–7,200	0x23E0	xx10 0011 1110 0000

Internal Temperature

The TEMP_OUT register (see Table 18) provides access to an internal temperature measurement. Set DIN = 0x0A00 to request the contents of this register. Mask off the upper four bits, then convert the remaining 12-bit binary number into a decimal equivalent, subtract 1278, multiply it by –0.47 and add 25 to convert this number into °C. See Table 19 for examples of this format. Note that this internal temperature measurement provides an indicator of condition changes, not an absolute measurement of conditions outside of the package.

Table 18. TEMP_OUT (Base Address = 0x0A), Read Only

Bits	Description
[15:0]	Internal temperature data, binary format, sensitivity = –0.47°/LSB, 25°C = 1278 LSB = 0x04FE

Table 19. Internal Temperature Data Format Examples

Temperature (°C)	LSB	Hex	Binary
+125	1065	0x0429	xxxx 0100 0010 1001
25 + 0.47	1277	0x04FD	xxxx 0100 1111 1101
+25	1278	0x04FE	xxxx 0100 1111 1110
25 – 0.047	1279	0x04FF	xxxx 0100 1111 1111
0	1331	0x0533	xxxx 0101 0011 0011
–40	1416	0x0588	xxxx 0101 1000 1000

Power Supply

The SUPPLY_OUT register (see Table 20) provides a digital measurement for the supply voltage on the VDD pins (see Figure 5). Set DIN = 0x0200 to request the contents of this register. See Table 21 for examples of this data format.

Table 20. SUPPLY_OUT (Base Address = 0x02), Read Only

Bits	Description
15	New data bit = 1, when register contains un-read data
14	Error/alarm = 1, when STATUS ≠ 0x0000
[15:0]	Power supply measurement data, binary format, 1 LSB = 0.00030518 V, 0 V = 0x0000

Table 21. Power Supply Data Format Examples

Supply Level (V)	LSB	Hex	Binary
3.6	11,796	0x2E14	xx10 1110 0001 0100
3.3 + 0.00030518	10,814	0x2A3E	xx10 1010 0011 1110
3.3	10,813	0x2A3D	xx10 1010 0011 1101
3.3 – 0.00030518	10,812	0x2A3C	xx10 1010 0011 1100
3.0	9,830	0x2666	xx10 0110 0110 0110

Auxiliary ADC

The AUX_ADC register (see Table 22) provides a digital measurement for the AUX_ADC input pin (see Figure 5). Set DIN = 0x0800 to request the contents of this register. See Table 23 for examples of this data format.

Table 22. AUX_ADC (Base Address = 0x08), Read Only

Bits	Description
15	New data bit = 1, when register contains un-read data
14	Error/alarm = 1, when STATUS ≠ 0x0000
[13:12]	Not used
[15:0]	Auxiliary ADC data, binary format, 1 LSB = 0.0006105 V, 0 V = 0x0000

Table 23. Auxiliary ADC Data Format Examples

Supply Level (V)	LSB	Hex	Binary
2.5	4095	0xFFFF	xxxx 1111 1111 1111
0.001221	2	0x002	xxxx 0000 0000 0010
0.0006105	1	0x001	xxxx 0000 0000 0001
0	0	0x000	xxxx 0000 0000 0000

OPERATION CONTROL REGISTERS

Internal Sample Rate

The SMPL_PRD register controls the ADIS16209 internal sample rate and has two parts: a selectable time base and a multiplier. The following relationship produces the sample rate:

$$t_s = t_B \times N_S + 122.07 \mu s$$

Table 24. SMPL_PRD Bit Descriptions

Bit	Description	(Default = 0x0014)
15:8	Not used	
7	Time base (t _B): 0 = 244.14 μs, 1 = 7.568 ms	
6:0	Increment setting (N _S)	

An example calculation of the default sample period follows:

$$SMPL_PRD = 0x01, B_7 - B_0 = 00000001$$

$$B_7 = 0 \rightarrow t_B = 244.14 \mu s, B_6 \dots B_0 = 000000001 \rightarrow N_S = 1$$

$$t_s = t_B \times N_S + 122.07 \mu s = 244.14 \times 1 + 122.07 = 366.21 \mu s$$

$$f_s = 1/t_s = 2731 \text{ SPS}$$

The sample rate setting has a direct impact on the SPI data rate capability. For sample rates ≥546 SPS, the SPI SCLK can run at a rate up to 2.5 MHz. For sample rates <546 SPS, the SPI SCLK can run at a rate up to 1 MHz. The sample rate setting also affects power dissipation. When the sample rate is set to <546 SPS, power dissipation typically reduces by a factor of 68%. The two different modes of operation offer a system-level trade-off between performance (sample rate, serial transfer rate) and power dissipation.

Power Management

In addition to offering two different performance modes for power optimization, the ADIS16209 offers a programmable shutdown period that the SLP_CNT register controls.

Table 25. SLP_CNT Bit Descriptions

Bit	Description	(Default = 0x0000)
15:8	Not used	
7:0	Data bits, 0.5 seconds/LSB	

For example, writing 0x08 to the SLP_CNT register places the ADIS16209 into sleep mode for 4 sec. The only way to stop this process is to remove power or reset the device.

Digital Filtering

The AVG_CNT register controls the moving average digital filter, which determines the size of the moving average filter in eight power-of-two step sizes (that is, 2^M = 1, 2, 4, 16, 32, 64, 128, and 256). Filter setup requires one simple step: write the appropriate M factor to the assigned bits in the AVG_CNT register. Note that the default settings for AVG_CNT and SMPL_PRD provide the best accuracy but require approximately 1.28 seconds to settle.

Table 26. AVG_CNT Bit Descriptions

Bit	Description	(Default = 0x0008)
15:4	Not used	
3:0	Power-of-two step size, maximum binary value = 1000	

The following equation offers a frequency response relationship for this filter:

$$H_A(f) = \frac{\sin(\pi \times N \times f \times t_s)}{N \times \sin(\pi \times f \times t_s)}$$

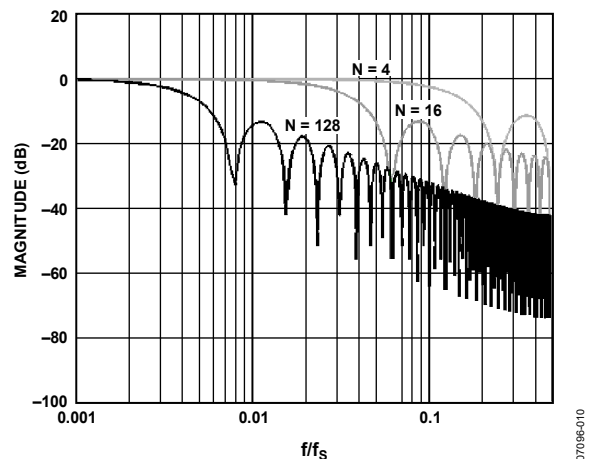

Figure 28. Frequency Response—Moving Average Filter

Digital I/O Lines

The ADIS16209 provides two general-purpose, digital input/output lines that have several configuration options.

Table 27. Digital I/O Line Configuration Registers

Function	Priority	Register
Data-Ready I/O Indicator	1	MSC_CTRL
Alarm Indicator	2	ALM_CTRL
General-Purpose I/O Configuration	3	GPIO_CTRL
General-Purpose I/O Line Communication		GPIO_CTRL

Data-Ready I/O Indicator

The MSC_CTRL register provides controls for a data-ready function. For example, writing 0x05 to this register enables this function and establishes DIO2 as an active-low, data-ready line. The duty cycle is 25% ($\pm 10\%$ tolerance).

Table 28. MSC_CTRL Bit Descriptions

Bit	Description	(Default = 0x0000)
15:11	Not used	
10	Self-test at power-on: 1 = disabled, 0 = enabled	
9	Not used	
8	Self-test enable: 1 = enabled, 0 = disabled	
7:3	Not used	
2	Data-ready enable: 1 = enabled, 0 = disabled	
1	Data-ready polarity: 1 = active high, 0 = active low	
0	Data-ready line select: 1 = DIO2, 0 = DIO1	

Self-Test

The self-test function applies an electrostatic force to the MEMS structure, inside of the core sensor, which causes the structure to move in a manner that simulates its response to gravity or linear acceleration. This provides an observable response in the accelerometer outputs that can serve as a validation of functional operation throughout the entire signal chain. The MSC_CTRL register (Table 28) provides two different options for using this function: manual (user-command) and automatic (during start-up/reset recovery).

The manual self-test control is an on/off control for the electrostatic force. Set MSC_CTRL[8] = 1 to turn it on and set MSC_CTRL[8] = 0 to turn it off. For normal operation, this will be in the off state but this control bit provides an opportunity to activate it at any time, so that system processors can apply application-relevant pass/fail criteria to the responses. When MSC_CTRL[10] = 1, the automatic self-test process runs during the power-on process. This runs the ADIS16209 through on/off states for the self-test, while observing the difference in accelerometer response. This process concludes with a comparison of the differential response in each accelerometer, with internal pass/fail limits and a report of the result to STATUS[5]. Once the ADIS16209 completes its start-up process, STATUS is available for a SPI-driven read, using DIN = 0x3C00 as the SPI input command (STATUS at Address 0x3C).

Linear motion during the start-up process, VDD ramp rates/waveform and the tilt of the device can introduce uncertainty into the on/off levels and in some cases, cause a false failure report to STATUS[5] (result = 0x0020). While the selection of the pass/fail limits incorporates most conditions, false failures are still possible.

When presented with a self-test failure indication, where STATUS \geq 0x0020, use the following process to test for basic function. This process assumes a stable power supply voltage and zero motion.

1. Set AVG_CNT = 0x0000 and SMPL_PRD = 0x0008, to optimize the response times during the self-test transitions, while keeping the ADIS16209 in low power mode. In this configuration, the self-test response will be similar to a step response of a single-pole, low-pass filter that has a cutoff frequency of 50 Hz.
2. Read XACCL_OUT and YACCL_OUT.
3. Set MSC_CTRL[8] = 1.
4. Delay > 20 ms, which provides the 50 Hz filter (internal to ADIS16209) with at least six time constants to settle.
5. Read XACCL_OUT and YACCL_OUT.
6. Calculate difference in measurements:
 - D-XACCL_OUT = XACCL_OUT (Step 6) – XACCL_OUT (Step 3)
 - D-YACCL_OUT = YACCL_OUT (Step 6) – YACCL_OUT (Step 3)
7. Set MSC_CTRL[8] = 0.
8. Restore the SMPL_PRD and AVG_CNT registers to their operational values.
9. Determine normal operation by making sure that the D-XACCL_OUT and D-YACCL_OUT produced a change of at least 350 LSB.

The 350 LSB pass/fail limit is approximately one-half of the data sheet specification for the minimum response time and is well above the noise floor. Because the purpose of this function is to identify gross functional issues, such as a zero response, this is a safe approach, given a stable platform and supply. When experiencing modest motion, some of the parameters may need further consideration to account for application-specific conditions.

General-Purpose I/O

The GPIO_CTRL register controls the direction and data of the general-purpose digital lines, DIO1 and DIO2. For example, writing a 0x02 to the GPIO_CTRL register sets DIO2 as an output line and DIO1 as an input line. Reading the data bits in GPIO_CTRL reveals the line logic level.

Table 29. GPIO_CTRL Bit Descriptions

Bit	Description	(Default = 0x0000)
15:10	Not used	
9	General-Purpose I/O Line 2 data	
8	General-Purpose I/O Line 1 data	
7:2	Not used	
1	General-Purpose I/O Line 2, data direction control: 1 = output, 0 = input	
0	General-Purpose I/O Line 1, data direction control: 1 = output, 0 = input	

Auxiliary DAC

The auxiliary DAC provides a 12-bit level adjustment function. The AUX_DAC register controls the operation of the auxiliary DAC function, which is useful for systems that require analog level controls. It offers a rail-to-rail buffered output that has a range of 0 V to 2.5 V. The DAC can drive its output to within 5 mV of the ground reference when it is not sinking current. As the output approaches ground, the linearity begins to degrade (100 LSB beginning point). As the sink current increases, the nonlinear range increases. The DAC output latch function, contained in the COMMAND register, provides continuous operation while writing to each byte of this register. The contents of this register are volatile, which means that the desired output level must be set after every reset and power cycle event.

Table 30. AUX_DAC Bit Descriptions

Bit	Description	(Default = 0x0000)
15:12	Not used	
11:0	Data bits, scale factor = 0.6105 mV/code Offset binary format, 0V = 0 codes	

Global Commands

The COMMAND register provides initiation bits for several commands that simplify many common operations. Writing a 1 to the assigned COMMAND bit exercises its function. When triggering one of the operations in the COMMAND register, only write to the low byte of this register, then wait until the operation completes before attempting new communications requests on the SPI.

Table 31. COMMAND Bit Descriptions

Bit	Description	(Default = 0x0000)
15:8	Not used	
7	Software reset	
6:5	Not used	
4	Clear status register (reset all bits to 0)	
3	Flash update; backs up all registers, see Table 8	
2	DAC data latch	
1	Factory calibration restore	
0	Autonull	

The software reset command restarts the internal processor, which loads all registers with the contents in their flash memory locations.

The flash update copies the contents of all the flash backup registers into their assigned, nonvolatile flash memory locations. This process takes approximately 50 ms and requires a power supply that is within the specified operating range. After waiting the appropriate time for the flash update to complete, verify successful completion by reading the STATUS register (if successful, the flash update error is 0). If the flash update was not successful, reading this error bit accomplishes two things: it alerts the system processor to try again, and it clears the error flag, which is required for flash memory access.

The DAC data latch command loads the contents of AUX_DAC into the DAC latches. Because the AUX_DAC contents must be updated one byte at a time, this command ensures a stable DAC output voltage during updates.

The autonull command provides a simple method for removing offset from the sensor outputs by taking the contents of the output data registers and loading the equal but opposite number into the offset calibration registers.

To accomplish this, the autonull command executes the following operations:

1. Read the XACCL_OUT, YACCL_OUT, XINCL_OUT, YINCL_OUT, and ROT_OUT values.
2. Change the polarity of these measurements.
3. Write the results to the XACCL_NULL, YACCL_NULL, XINCL_NULL, YINCL_NULL, and ROT_NULL registers.
4. Perform a manual backup of all user registers, using the flash memory bank.

When using the horizontal incline angle measurements (XINCL_OUT and YINCL_OUT), the autonull helps remove bias errors in the accelerometers, as well as orientation error, with respect to the horizontal plane (0 g). When using the vertical incline measurement (ROT_OUT), do not use the autonull function.

The accuracy of this operation depends on stable inertial conditions (zero acceleration or change in orientation, with respect to gravity) and optimal noise management during the measurement (see the Digital Filtering section).

The factory calibration restore command sets the offset null registers (XACCL_NULL, for example) back to their default values.

CALIBRATION REGISTERS

The ADIS16209 incorporates an extensive factory calibration and provides precision acceleration, incline, and rotational position data. For systems that require on-site calibration, user-programmable offset adjustment registers are available.

Table 32 provides the bit assignments for the following user-programmable calibration registers: XACCL_NULL and YACCL_NULL. Table 33 provides the bit assignments for the following user-programmable calibration registers: XINCL_NULL, YINCL_NULL, and ROT_NULL.

Table 32. Acceleration Offset Register Bit Designations

Bit	Description (Default = 0x0000)
15:14	Not used
13:0	Data bits, twos complement, sensitivity = 0.24414 mg/LSB

Table 33. Incline/Rotation Offset Register Bit Designations

Bit	Description (Default = 0x0000)
15:14	Not used
13:0	Data bits, twos complement, sensitivity = 0.025°/LSB

ALARM REGISTERS

The alarm function provides monitoring for two independent conditions. The ALM_CTRL register provides control inputs for data source, data filtering (prior to comparison), static/dynamic, and output indicator configurations. The ALM_MAGx registers establish the trigger threshold and polarity configurations. The ALM_SMPLx registers provide the numbers of samples to use in the dynamic rate-of-change configuration. The rate-of-change calculation is

$$Y_C = \frac{1}{N_{DS}} \sum_{n=1}^{N_{DS}} y(n+1) - y(n) \Rightarrow Alarm \Rightarrow \text{is } Y_C > \text{ or } < M_C ?$$

where:

N_{DS} is the number of samples in ALM_SMPLx.

$y(n)$ is the sampled output data.

M_C is the magnitude for comparison in ALM_MAGx.

> or < is determined by the MSB in ALM_MAGx.

Table 34. ALM_MAG1/ALM_MAG2 Bit Designations

Bit	Description (Default = 0x0000)
15	Comparison polarity: 1 = greater than, 0 = less than
14	Not used
13:0	Data bits, matches format of trigger source selection

Table 35. ALM_SMPL1/ALM_SMPL2 Bit Designations

Bit	Description (Default = 0x0001)
15:8	Not used
7:0	Data bits: number of samples (both 0x00 and 0x01 = 1)

Table 36. ALM_CTRL Bit Descriptions

Bit	Value	Description (Default = 0x0000)
15:12		Trigger source, Alarm 2
	0000	Disabled
	0001	Power supply
	0010	X-acceleration
	0011	Y-acceleration
	0100	Auxiliary ADC
	0101	Temperature sensor
	0110	X-axis incline angle
	0111	Y-axis incline angle
	1000	Rotational position
11:8		Trigger source, Alarm 1, same as Bits[15:12]
7		Not used
6		Alarm 2 rate-of-change control: 1 = enabled
5		Alarm 1 rate-of-change control: 1 = enabled
4		Alarm 2 filter: 1 = filtered data, 0 = no filter ¹
3		Alarm 1 filter: 1 = filtered data, 0 = no filter ¹
2		Alarm indicator, using DIO1/DIO2: 1 = enabled
1		Alarm indicator polarity: 1 = active high
0		Alarm indicator line select: 1 = DIO2, 0 = DIO1

¹ Incline and vertical angles always use filtered data in this comparison.

Status

The STATUS register provides a series of error flags that provide indicator functions for common system-level issues. After reading the contents of this register, set COMMAND[4] = 1 (DIN = 0xBE10) to reset all of its flags to zero.

Table 37. STATUS Bit Descriptions

Bit	Description	(Default = 0x0000)
15:10	Not used	
9	Alarm 2 status: 1 = active, 0 = inactive	
8	Alarm 1 status: 1 = active, 0 = inactive	
7:6	Not used	
5	Self-test diagnostic error flag: 1 = error condition, 0 = normal operation	
4	Not used	
3	SPI communications failure: 1 = error condition, 0 = normal operation	
2	Flash update failed: 1 = error condition, 0 = normal operation	
1	Power supply greater than 3.625 V: 1 > 3.625 V, 0 ≤ 3.625 V (normal)	
0	Power supply less than 2.975 V: 1 < 2.975 V, 0 ≥ 2.975 V (normal)	

APPLICATIONS INFORMATION

POWER SUPPLY CONSIDERATIONS

The ADIS16209 is a precision sensing system that uses an embedded processor for critical interface and signal processing functions. Supporting this processor requires a low impedance power supply, which can manage transient current demands that happen during normal operation, as well as during the start-up process. Transient current demands start when the voltage on the VDD pin reaches ~2.1 V. Therefore, it is important for the voltage on the VDD pin to reach 3 V as quickly as possible. Linear VDD ramp profiles that reach 3 V in 100 μ s provide reliable results when used in conjunction with design practices that support low dynamic source impedance. The ADP1712 is a linear regulator that can support the recommended ramp profile. See the [ADIS1620x/21x/22x Power Regulator Suggestion](#) page for a reference design for using this regulator with the ADIS16209.

Power-On-Reset Function

The ADIS16209 has a power-on-reset (POR) function that triggers a reset if the voltage on the VDD pin fails to transition between 2.35 V and 2.7 V within 128 ms.

Transient Current from VDD Ramp Rate

Because the ADIS16209 contains 2 μ F of decoupling capacitance on VDD and some systems may use additional filtering capacitance, the VDD ramp rate will have a direct impact on initial transient current requirements. Use this formula to estimate the transient current, associated with a particular capacitance (C) and VDD ramp rate (dV/dt).

$$i(t) = C \frac{dV}{dt}$$

For example, if VDD transitions from 0 V to +3.3 V in 33 μ s, dV/dt is equal to 100000 V/S (3.3 V/33 μ s). When charging the internal 2 μ F capacitor (no external capacitance), the charging current for this ramps rate is 200 mA, during the 33 μ s ramp time. This relationship provides a tool for evaluating the initial charging currents against the current limit thresholds of system power supplies, which can cause power supply interruptions and the appearance of failed start-ups. This may also be important for maintaining surge current ratings of any series elements as well

Filter Settling

The SMPL_PRD and AVG_CNT settings have a direct impact on the filter settling during turn-on. For example, when using the default settings for these filters, the SUPPLY_OUT register takes approximately 1.28 seconds to settle. During this time, the SUPPLY_OUT register experiences a linear rise (assuming that VDD is stable and greater than 3.0 V) and the low-voltage flag (STATUS[0]) is low. When the SUPPLY_OUT register reaches a value that exceeds 2.975 V, the STATUS[0] flag automatically lowers.

ASSEMBLY

When developing a process flow for installing ADIS16209 devices on PCBs, see the JEDEC standard document J-STD-020C for reflow temperature profile and processing information. The ADIS16209 can use the Sn-Pb eutectic process and the Pb-free eutectic process from this standard, with one exception: the peak temperature exposure is 240°C. For a more complete list of assembly process suggestion, see the [ADIS162xx LGA Assembly Guidelines](#) page at the Engineer Zone/MEMS Community website. Figure 29 provides an example pad layout for the location of the ADIS16209 on a printed circuit board (PCB).

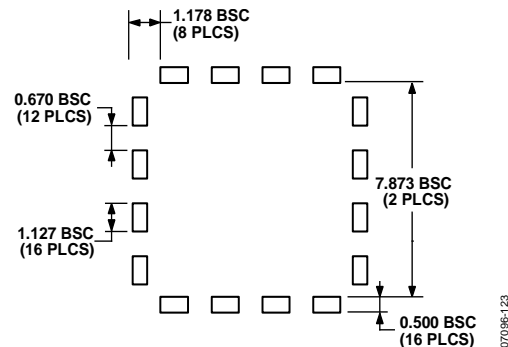
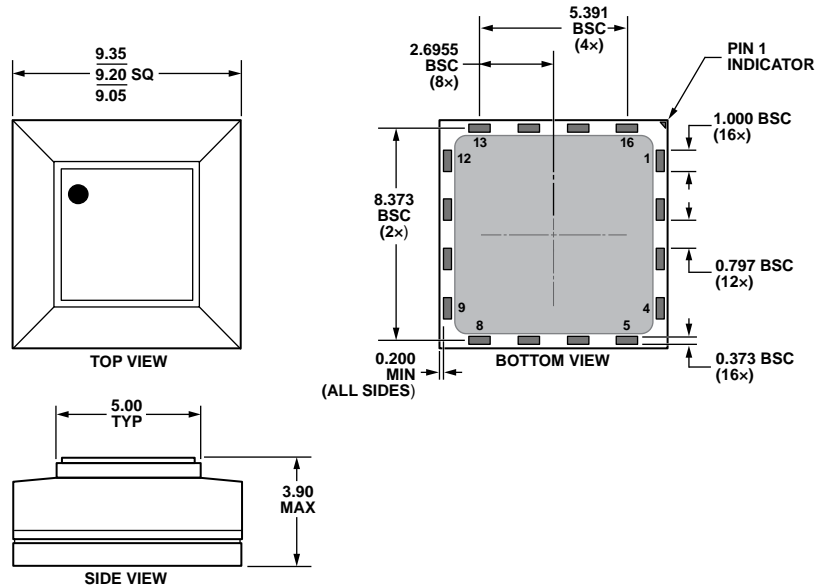

Figure 29. Example Pad Layout

OUTLINE DIMENSIONS



121409-C

Figure 32. 16-Terminal Stacked Land Grid Array [LGA]
(CC-16-2)
Dimensions shown in millimeters

ORDERING GUIDE

Model ¹	Temperature Range	Package Description	Package Option
ADIS16209CCCZ	-40°C to +125°C	16-Terminal Stacked Land Grid Array [LGA]	CC-16-2
ADIS16209/PCBZ		Evaluation Board	
EVAL-ADIS2Z		Evaluation System	

¹ Z = RoHS Compliant Part.

Mouser Electronics

Authorized Distributor

Click to View Pricing, Inventory, Delivery & Lifecycle Information:

[Analog Devices Inc.:](#)

[ADIS16209CCCZ](#) [ADIS16209/PCBZ](#)