

## Silicon PIN Photodiode, RoHS Compliant, Released for Lead (Pb)-free Reflow Soldering, AEC-Q101 Released

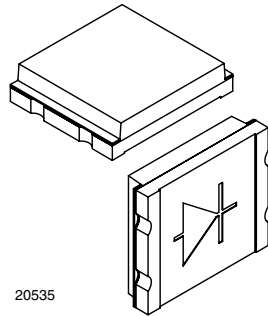

20535

### DESCRIPTION

TEMD5020X01 is a high speed and high sensitive PIN photodiode. It is a miniature surface mount device (SMD) including the chip with a 4.4 mm<sup>2</sup> sensitive area detecting visible and near infrared radiation.

### FEATURES

- Package type: surface mount
- Package form: top view
- Dimensions (L x W x H in mm): 5 x 4.24 x 1.12
- Radiant sensitive area (in mm<sup>2</sup>): 4.4
- AEC-Q101 qualified
- High photo sensitivity
- High radiant sensitivity
- Suitable for visible and near infrared radiation
- Fast response times
- Angle of half sensitivity:  $\varphi = \pm 65^\circ$
- Floor life: 72 h, MSL 4, acc. J-STD-020
- Lead (Pb)-free reflow soldering
- Lead (Pb)-free component
- Compliant to RoHS directive 2002/95/EC and in accordance to WEEE 2002/96/EC

**RoHS**  
COMPLIANT

### APPLICATIONS

- High speed photo detectors

### PRODUCT SUMMARY

COMPONENT	I <sub>ra</sub> (μA)	φ (deg)	λ <sub>0.1</sub> (nm)
TEMD5020X01	35	± 65	430 to 1100

#### Note

Test conditions see table "Basic Characteristics"

### ORDERING INFORMATION

ORDERING CODE	PACKAGING	REMARKS	PACKAGE FORM
TEMD5020X01	Tape and reel	MOQ: 1500 pcs, 1500 pcs/reel	Top view

#### Note

MOQ: minimum order quantity

### ABSOLUTE MAXIMUM RATINGS

PARAMETER	TEST CONDITION	SYMBOL	VALUE	UNIT
Reverse voltage		V <sub>R</sub>	60	V
Power dissipation	T <sub>amb</sub> ≤ 25 °C	P <sub>V</sub>	215	mW
Junction temperature		T <sub>j</sub>	100	°C
Operating temperature range		T <sub>amb</sub>	- 40 to + 100	°C
Storage temperature range		T <sub>stg</sub>	- 40 to + 110	°C
Soldering temperature	Acc. reflow solder profile fig. 8	T <sub>sd</sub>	260	°C
Thermal resistance junction/ambient	Soldered on PCB with pad dimensions: 4 mm x 4 mm	R <sub>thJA</sub>	350	K/W

#### Note

T<sub>amb</sub> = 25 °C, unless otherwise specified

BASIC CHARACTERISTICS						
PARAMETER	TEST CONDITION	SYMBOL	MIN.	TYP.	MAX.	UNIT
Forward voltage	$I_F = 50 \text{ mA}$	$V_F$		1	1.3	V
Breakdown voltage	$I_R = 100 \text{ }\mu\text{A}, E = 0$	$V_{(BR)}$	60			V
Reverse dark current	$V_R = 10 \text{ V}, E = 0$	$I_{ro}$		2	30	nA
Diode capacitance	$V_R = 0 \text{ V}, f = 1 \text{ MHz}, E = 0$	$C_D$		48		pF
	$V_R = 3 \text{ V}, f = 1 \text{ MHz}, E = 0$	$C_D$		17	40	pF
Open circuit voltage	$E_e = 1 \text{ mW/cm}^2, \lambda = 950 \text{ nm}$	$V_o$		350		mV
Temperature coefficient of $V_o$	$E_e = 1 \text{ mW/cm}^2, \lambda = 950 \text{ nm}$	$TK_{V_o}$		-2.6		mV/K
Short circuit current	$E_e = 1 \text{ mW/cm}^2, \lambda = 950 \text{ nm}$	$I_k$		32		$\mu\text{A}$
Temperature coefficient of $I_k$	$E_e = 1 \text{ mW/cm}^2, \lambda = 950 \text{ nm}$	$TK_{I_k}$		0.1		%/K
Reverse light current	$E_e = 1 \text{ mW/cm}^2, \lambda = 950 \text{ nm}, V_R = 5 \text{ V}$	$I_{ra}$	25	35		$\mu\text{A}$
Angle of half sensitivity		$\phi$		$\pm 65$		deg
Wavelength of peak sensitivity		$\lambda_p$		900		nm
Range of spectral bandwidth		$\lambda_{0.1}$		430 to 1100		nm
Noise equivalent power	$V_R = 10 \text{ V}, \lambda = 950 \text{ nm}$	NEP		$4 \times 10^{-14}$		$\text{W}/\sqrt{\text{Hz}}$
Rise time	$V_R = 10 \text{ V}, R_L = 1 \text{ k}\Omega, \lambda = 820 \text{ nm}$	$t_r$		100		ns
Fall time	$V_R = 10 \text{ V}, R_L = 1 \text{ k}\Omega, \lambda = 820 \text{ nm}$	$t_f$		100		ns

**Note**

$T_{amb} = 25 \text{ }^\circ\text{C}$ , unless otherwise specified

**BASIC CHARACTERISTICS**

$T_{amb} = 25 \text{ }^\circ\text{C}$ , unless otherwise specified

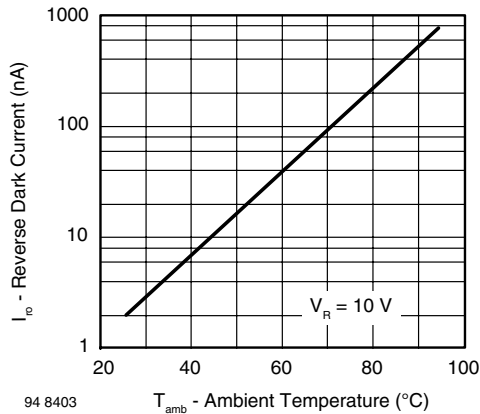

Fig. 1 - Reverse Dark Current vs. Ambient Temperature

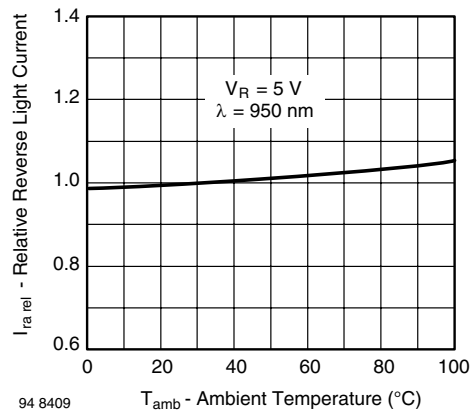

Fig. 2 - Relative Reverse Light Current vs. Ambient Temperature

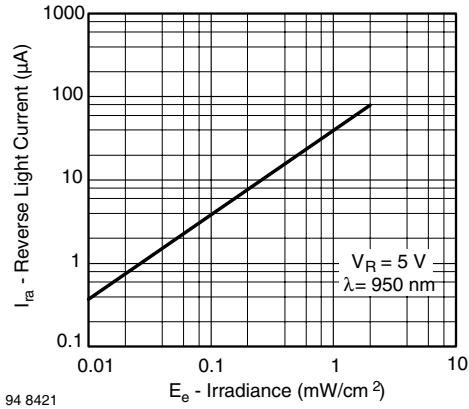

Fig. 3 - Reverse Light Current vs. Irradiance

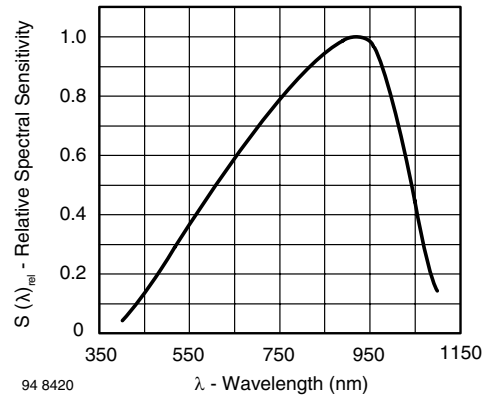

Fig. 6 - Relative Spectral Sensitivity vs. Wavelength

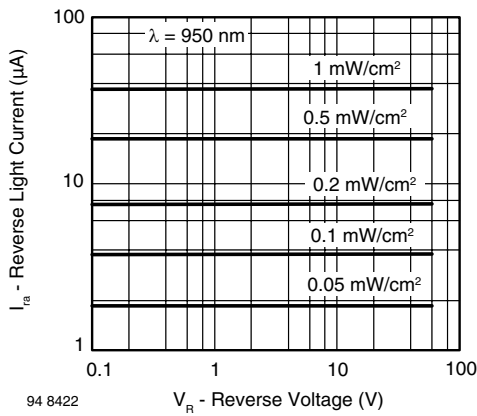

Fig. 4 - Reverse Light Current vs. Reverse Voltage

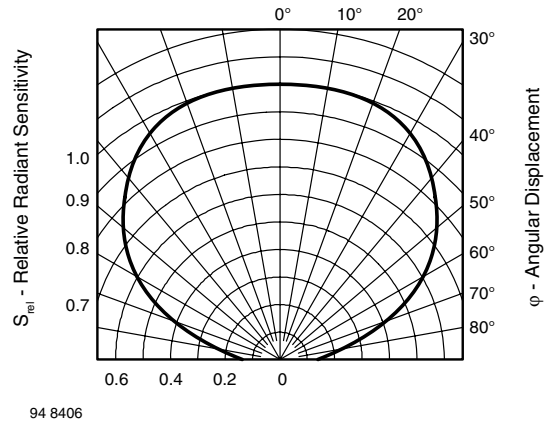

Fig. 7 - Relative Radiant Sensitivity vs. Angular Displacement

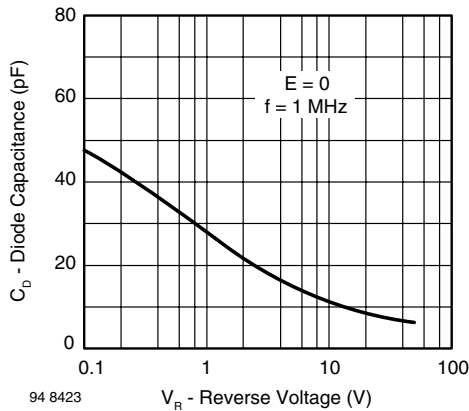

Fig. 5 - Diode Capacitance vs. Reverse Voltage

# TEMD5020X01



Vishay Semiconductors Silicon PIN Photodiode, RoHS Compliant, Released for Lead (Pb)-free Reflow Soldering, AEC-Q101 Released

## PACKAGE DIMENSIONS in millimeters

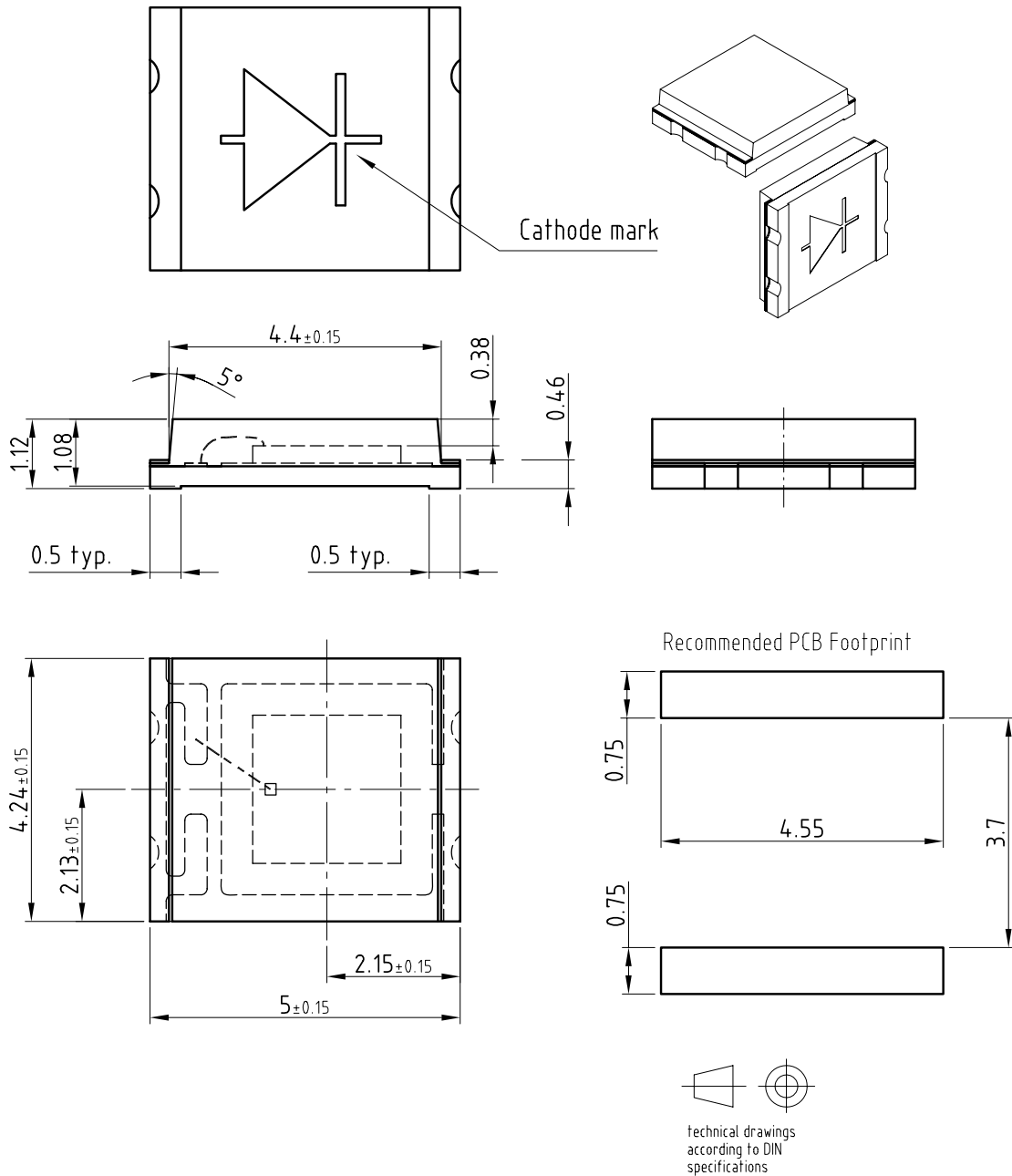

Drawing-No.: 6.541-5059.01-4  
Issue: 4; 26.04.07  
19280

Not indicated tolerances  $\pm 0.1$



## SOLDER PROFILE

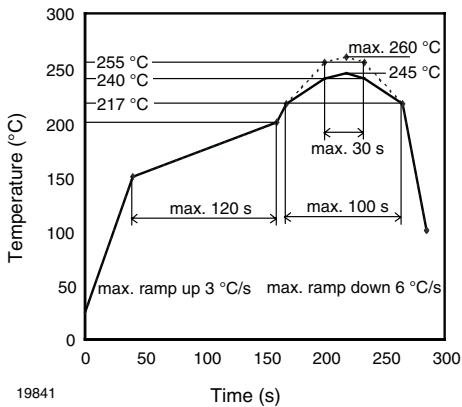

19841

Fig. 8 - Lead (Pb)-free Reflow Solder Profile acc. J-STD-020D

## DRYPACK

Devices are packed in moisture barrier bags (MBB) to prevent the products from moisture absorption during transportation and storage. Each bag contains a desiccant.

## FLOOR LIFE

Time between soldering and removing from MBB must not exceed the time indicated in J-STD-020:

Moisture sensitivity: level 4

Floor life: 72 h

Conditions:  $T_{amb} < 30\text{ °C}$ ,  $RH < 60\%$

## DRYING

In case of moisture absorption devices should be baked before soldering. Conditions see J-STD-020 or recommended conditions:

192 h at 40 °C (+ 5 °C),  $RH < 5\%$

or

96 h at 60 °C (+ 5 °C),  $RH < 5\%$ .



## Disclaimer

All product specifications and data are subject to change without notice.

Vishay Intertechnology, Inc., its affiliates, agents, and employees, and all persons acting on its or their behalf (collectively, "Vishay"), disclaim any and all liability for any errors, inaccuracies or incompleteness contained herein or in any other disclosure relating to any product.

Vishay disclaims any and all liability arising out of the use or application of any product described herein or of any information provided herein to the maximum extent permitted by law. The product specifications do not expand or otherwise modify Vishay's terms and conditions of purchase, including but not limited to the warranty expressed therein, which apply to these products.

No license, express or implied, by estoppel or otherwise, to any intellectual property rights is granted by this document or by any conduct of Vishay.

The products shown herein are not designed for use in medical, life-saving, or life-sustaining applications unless otherwise expressly indicated. Customers using or selling Vishay products not expressly indicated for use in such applications do so entirely at their own risk and agree to fully indemnify Vishay for any damages arising or resulting from such use or sale. Please contact authorized Vishay personnel to obtain written terms and conditions regarding products designed for such applications.

Product names and markings noted herein may be trademarks of their respective owners.