

General Description

The MAX20003 evaluation kit (EV kit) demonstrates the MAX20002/MAX20003 high-voltage, current-mode step-down converters with low operating current. The EV kit operates over a wide 3.5V to 36V input range and the output is set for 5V at 3A.

The EV kit comes with the MAX20003ATPA/V+ installed.

Features and Benefits

- Wide 3.5V to 36V Input Supply Range
- Forced-PWM or Skip-Mode Operation
- Programmable Switching Frequency
- Power-Good Output
- Proven PCB Layout
- Fully Assembled and Tested

Ordering Information appears at end of data sheet.

Quick Start

Required Equipment

- MAX20003 EV kit
- 14V, 2A DC power supply
- Electronic load capable of 3A
- Digital voltmeter (DVM)

Procedure

The EV kit is fully assembled and tested. Follow the steps below to verify board operation. **Caution: Do not turn on supplies until all connections are made.**

- 1) Verify that jumpers JU1–JU4 are in their default positions, as shown in Tables 1–4.
- 2) Connect the power supply between the SUPSW and nearest PGND test points.
- 3) Connect the 3A electronic load between the OUT and nearest PGND test points.
- 4) Connect the DVM between the OUT and nearest PGND test points.
- 5) Turn on the power supply.

Table 1. EN Configuration (JU1)

SHUNT POSITION	DESCRIPTION
1-2*	Connects the EN pin to the voltage at SUP for normal operation
2-3	Connects the EN pin to ground to enter shutdown mode

*Default position.

Table 2. Mode of Operation (JU2)

SHUNT POSITION	MODE PIN	MODE
1-2*	Connected to BIAS	Forced-PWM mode
2-3	Connected to AGND	Skip mode
Not installed	Connected to an external clock	Forced-PWM mode (device syncs to an external clock)

*Default position.

Table 3. Spread Spectrum (JU3)

SHUNT POSITION	MODE PIN	MODE
1-2*	Connected to BIAS	Spread-spectrum enabled
2-3	Connected to PGND	Spread-spectrum disabled

*Default position.

Table 4. PGOOD (JU4)

SHUNT POSITION	MODE
Installed	PGOOD pulled high to VL
Not installed	PGOOD unconnected

- 6) Enable the electronic load.
- 7) Verify that the voltage at the OUT test point is approximately 5V.

Detailed Description of Hardware

The MAX20003 EV kit demonstrates the MAX20003 high-voltage, high-frequency, step-down converter with low operating current. The EV kit operates over a wide 3.5V to 36V input range and the output is set for 5V at 3A.

Enable (EN)

Place a shunt in the 1-2 position on jumper JU1 for normal operation. To place the device into shutdown mode, move the shunt on JU1 to the 2-3 position.

Synchronization Input (FSYNC)

The EV kit features jumper JU2 to control the synchronization input (FSYNC). The device synchronizes to an external signal applied to FSYNC. Connect FSYNC to AGND to enable skip-mode operation. Connect to BIAS or to an external clock to enable fixed-frequency forced-PWM mode operation.

To use an external clock, uninstall the shunt on JU2 and apply the signal at the FSYNC test point. The external clock frequency at FSYNC can be higher or lower than the internal clock by 20%. Ensure that the duty cycle of the external clock used has a minimum 100ns pulse width.

Spread-Spectrum Option (SPS)

The EV kit provides jumper JU3 that allows SPS to be pulled high (VL) or pulled low (PGND). Connect SPS high to enable spread spectrum where the operating frequency is varied $\pm 3\%$ centered on FOSC. Connect SPS low to disable the spread-spectrum feature.

Setting the Switching Frequency (FOSC)

The EV kit switching frequency is set by a resistor, R_{FOSC} (R4), connected from FOSC to AGND. Refer to TOC 08 in the *Typical Operating Characteristics* section in the MAX20002/MAX20003 IC data sheet for the correct R_{FOSC} (R4) value.

Power-Good Output (PGOOD)

The EV kit provides a PGOOD test point to monitor the status of the device output. PGOOD asserts when V_{OUT} rises above 95% of its regulation voltage. PGOOD deasserts when V_{OUT} drops below 92.5% of its regulation voltage.

Output

Connect FB to BIAS for a fixed +5V (EV kit default output) or a fixed +3.3V output voltage. To set the output to other voltages between 1V and 10V, connect a resistive divider from output (OUT) to FB to AGND. Use the following formula to determine the R7 and R8 of the resistive divider network:

$$R7 = R8 \times \left(\frac{V_{OUT}}{V_{FB}} - 1 \right)$$

where $V_{FB} = 1V$.

Operation at 400kHz Switching Frequency

For 400kHz switching frequency, the following components need to be changed to:

- R4 = 73.2k Ω
- L1 = 6.8 μ H (recommend Coilcraft XAL5050-682MEB)
- R1 = 16.5k Ω
- C10 = 4,700pF
- C11 = 6.8pF

Additional capacitance on C7 and C8 may be needed, depending on transient performance.

Component List

DESIGNATION	QTY	DESCRIPTION
C1	1	47 μ F \pm 20%, 50V aluminum electrolytic capacitor (8.00mm x 6.20mm) Panasonic EEE-FK1H470P
C2	1	4.7 μ F \pm 10%, 50V X7R ceramic capacitor (1210) Murata GCM32ER71H475KA55L
C3, C5	2	0.1 μ F \pm 10%, 50V X7R ceramic capacitors (0603) Murata GCM188R71H104KA57D
C4	1	2.2 μ F \pm 10%, 50V X7R ceramic capacitor (0805) TDK C2012X7R1H2225K125AC
C6, C14, C15	3	0.1 μ F \pm 10%, 50V X7R ceramic capacitors (0402) TDK CGA2B3X7R1H104K050BB
C7, C8	2	22 μ F \pm 10%, 10V X7R ceramic capacitors (1210) Murata GCM32ER71A226KE12L
C9	1	2.2 μ F \pm 10%, 10V X7R ceramic capacitor (0603) Murata GRM188R71A225K
C10, C16	2	1,000pF \pm 10%, 50V X7R ceramic capacitors (0402) Murata GRM155R71H102K
C11	1	10pF \pm 5%, 50V C0G ceramic capacitor (0402) Murata GRM1555C1H100J
C12, C17	0	Not installed, ceramic capacitors (0402)

DESIGNATION	QTY	DESCRIPTION
C13	0	Not installed, ceramic capacitor (0603)
JU1–JU3	3	3-pin headers
JU4	1	2-pin header
L1	1	2.2 μ H, 9.2A inductor (5.5mm x 5.7mm) Coilcraft XAL5030-222MEB
L2	1	Ferrite bead (1206) Würth 742792141
PGND	2	Black test points
PGOOD, SUP, SUPSW, VOUT	4	Red test points
R1	1	20.0k Ω \pm 1% resistor (0402)
R2, R6, R11	3	0 Ω \pm 5% resistors (0402)
R3	1	100k Ω \pm 5% resistor (0402)
R4	1	12.1k Ω \pm 1% resistor (0402)
R5	1	10k Ω \pm 5% resistor (0402)
R7, R8, R10	0	Not installed, resistors (0402)
R9	1	0 Ω \pm 5% resistors (1210)
U1	1	Automotive buck converter (20 TQFN-EP*) Maxim MAX20003ATPA/V+
—	4	Shunts
—	1	PCB: MAX20003 EVALUATION KIT

*EP = Exposed pad.

Component Suppliers

SUPPLIER	PHONE	WEBSITE
Coilcraft Inc.	847-639-6400	www.coilcraft.com
Murata Americas	770-436-1300	www.murataamericas.com
Panasonic Corp.	800-344-2112	www.panasonic.com
Würth Elektronik GmbH & Co. KG	201-785-8800	www.we-online.com

Note: Indicate that you are using the MAX20003 when contacting these component suppliers.

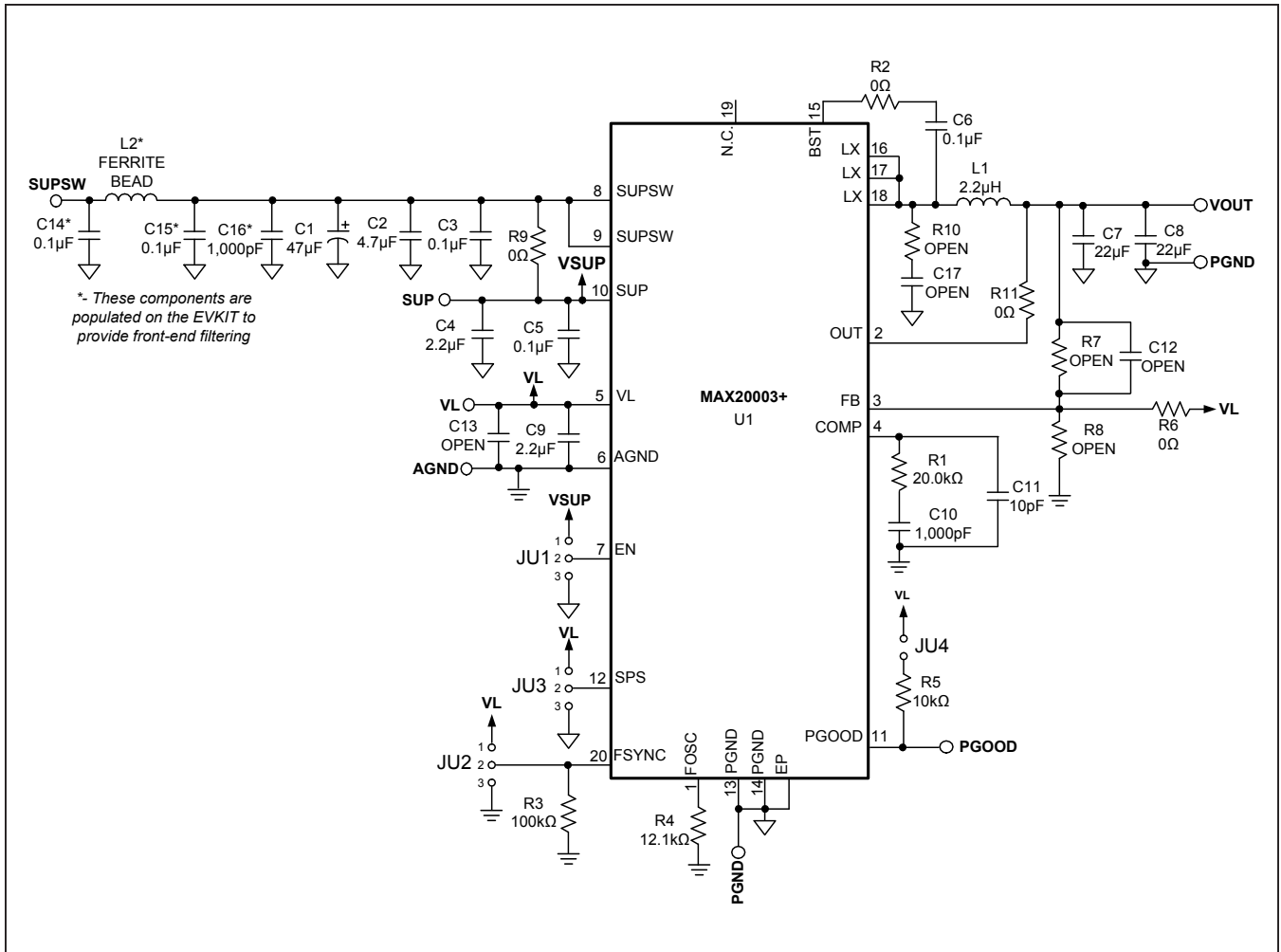

Figure 1. MAX20003 EV Kit Schematic

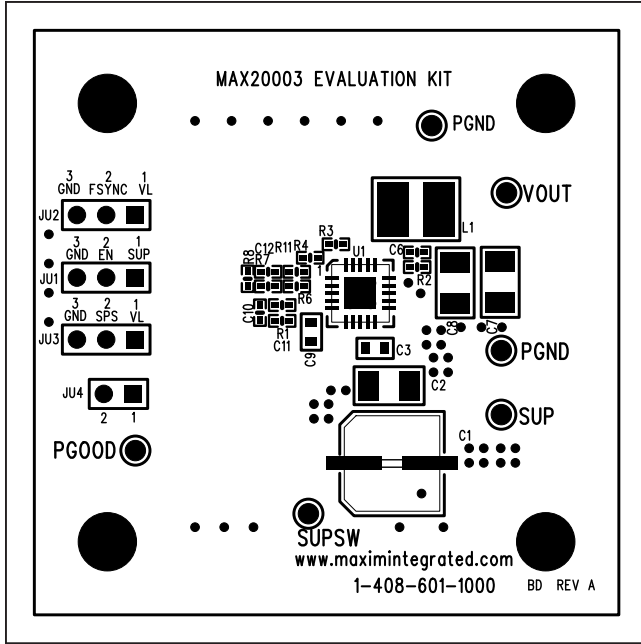

Figure 2. MAX20003 EV Kit Component Placement Guide—Component Side

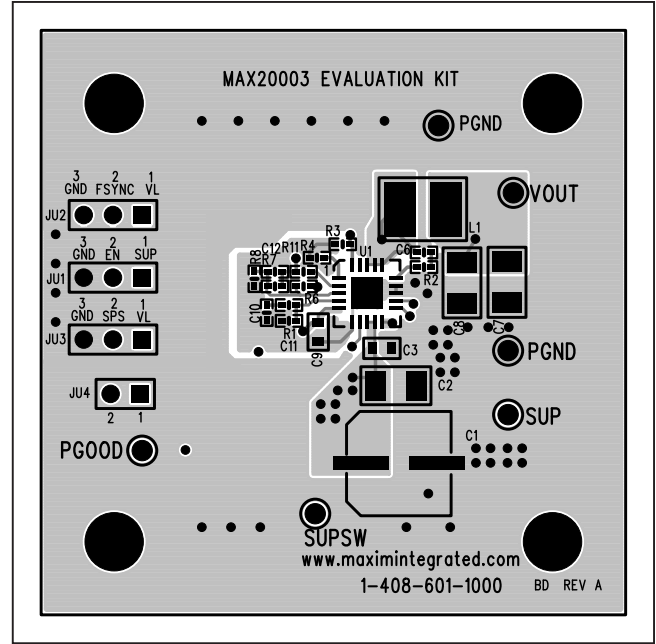

Figure 3. MAX20003 EV Kit PCB Layout—Component Side

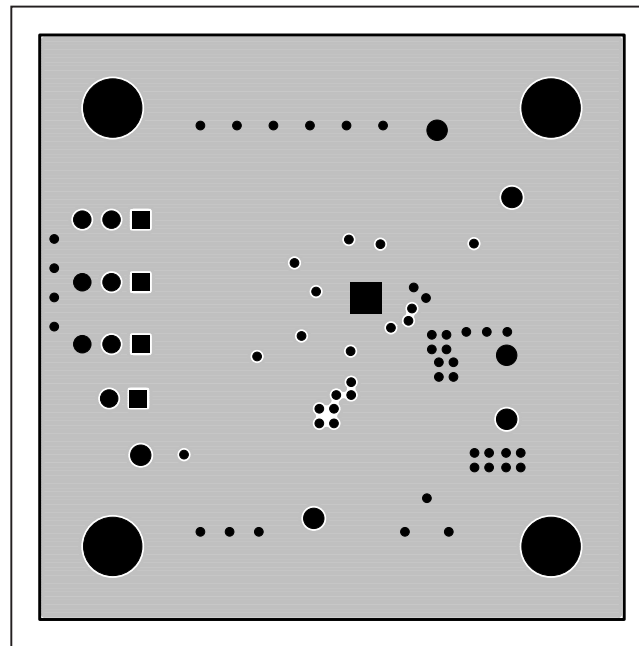

Figure 4. MAX20003 EV Kit PCB Layout—Layer 2

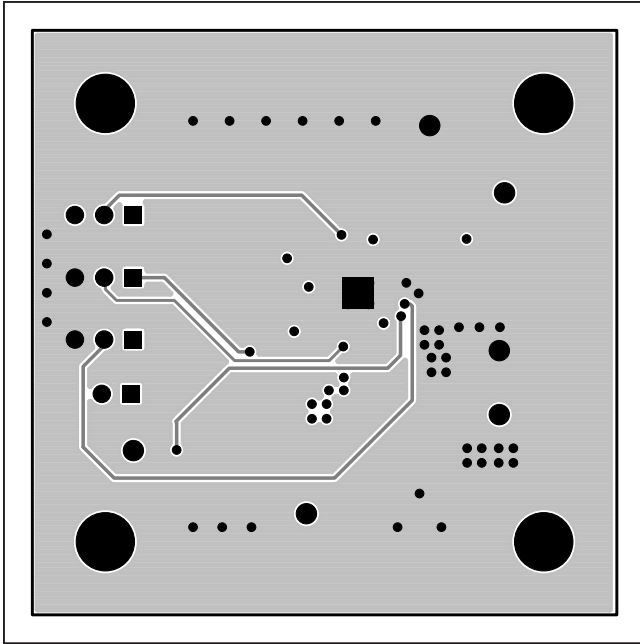

Figure 5. MAX20003 EV Kit PCB Layout—Layer 3

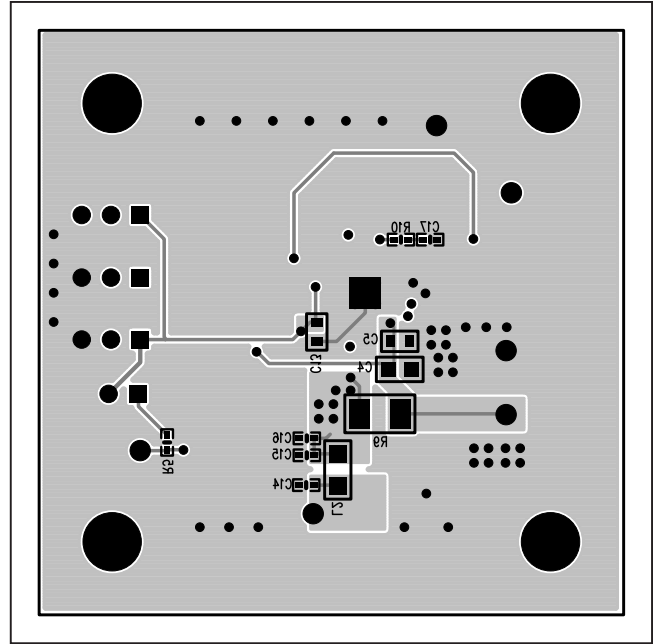

Figure 6. MAX20003 EV Kit PCB Layout—Solder Side

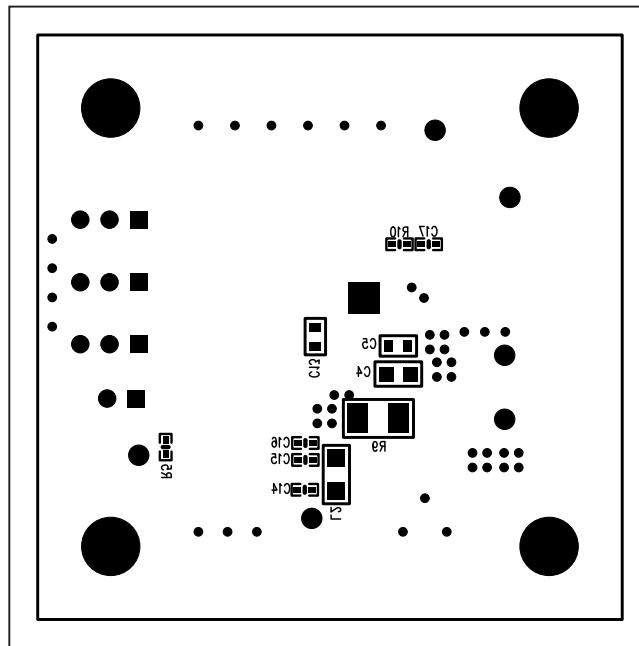

Figure 7. MAX20003 EV Kit Component Placement Guide—Solder Side

Ordering Information

PART	TYPE
MAX20003EVKIT#	EV Kit

#Denotes RoHS compliant.

Revision History

REVISION NUMBER	REVISION DATE	DESCRIPTION	PAGES CHANGED
0	5/14	Initial release	—

For pricing, delivery, and ordering information, please contact Maxim Direct at 1-888-629-4642, or visit Maxim Integrated's website at www.maximintegrated.com.

Maxim Integrated cannot assume responsibility for use of any circuitry other than circuitry entirely embodied in a Maxim Integrated product. No circuit patent licenses are implied. Maxim Integrated reserves the right to change the circuitry and specifications without notice at any time.

Mouser Electronics

Authorized Distributor

Click to View Pricing, Inventory, Delivery & Lifecycle Information:

[Maxim Integrated:](#)

[MAX20003EVKIT#](#)