

1206 F

Engineer's Kit : EK-1206F-X

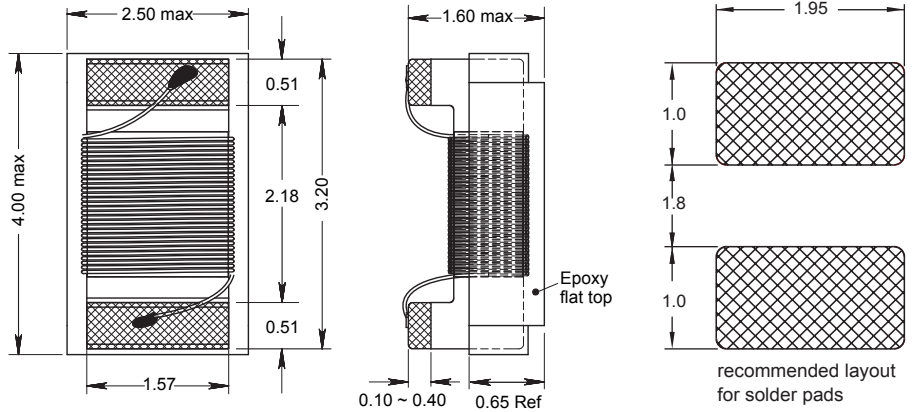

Chip Inductors for RF Applications (wire wound -open)

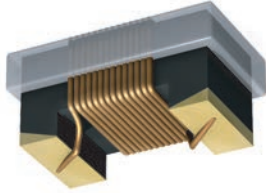
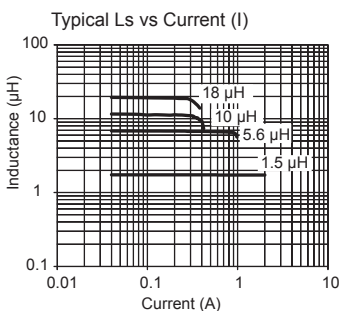
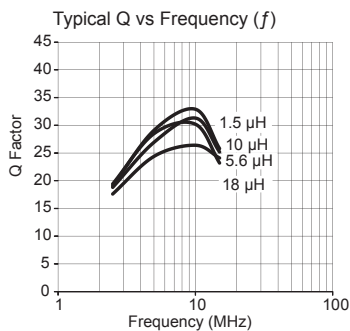
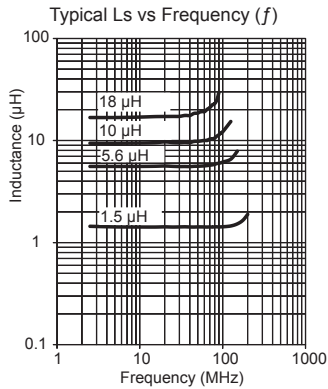
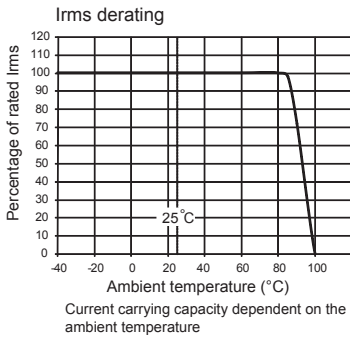

Part No	Inductance	f _L	Tol	Q	f _α	SRF	DCR	Rated DC
	L (µH)	(MHz)	± (%)	min	(MHz)	(MHz)	max (Ω)	Current (mA)
1206F-1R0K-YY	1.0	7.9	10	25	7.9	300 min	0.98	350
1206F-1R5K-YY	1.5	7.9	10	25	7.9	240 min	1.2	320
1206F-1R8K-YY	1.8	7.9	10	25	7.9	200 min	1.2	320
1206F-2R2K-YY	2.2	7.9	10	25	7.9	200 min	1.3	300
1206F-2R7K-YY	2.7	7.9	10	25	7.9	190 min	1.4	300
1206F-3R3K-YY	3.3	7.9	10	25	7.9	160 min	1.5	280
1206F-3R9K-YY	3.9	7.9	10	25	7.9	160 min	1.9	280
1206F-4R7K-YY	4.7	7.9	10	25	7.9	140 typ	2.2	280
1206F-5R6K-YY	5.6	7.9	10	25	7.9	120 typ	2.4	260
1206F-6R8K-YY	6.8	7.9	10	25	7.9	110 typ	2.8	240
1206F-8R2K-YY	8.2	7.9	10	25	7.9	100 typ	3.1	220
1206F-100K-YY	10	7.9	10	25	7.9	100 typ	4.0	200
1206F-120K-YY	12	7.9	10	18	7.9	90 typ	4.6	200
* 1206F-150K-YY	15	2.5	10	16	2.5	75 typ	8.2	160
* 1206F-180K-YY	18	2.5	10	16	2.5	75 typ	9.0	130
1206F-470K-YY	47	2.5	10	18	2.5	25 typ	11.1	80
* 1206F-101K-YY	100	2.5	10	18	2.5	13 typ	21	80

Core Material : Ferrite

Revision date : 10 Aug 2016

SPQ : Taped / Reel 1000 [-08]
2000 [-01]
7500 [-04]

Remarks: - For not listed inductance values please check availability with us.
- 2% and 5% available on request.
- All are AEC-Q200 Standard approved EXCEPT *.

Chip Inductors for RF Applications / Medical Applications (Wire wound-open)

FASTRON wire wound chip inductors are designed particularly for RF applications that require optimal Q on high frequency circuits. Its gold flash pad metallization provides better solderability for a higher yield in your production. In addition, their encapsulation not only protects the winding but also allows surface mount assembly. It comes in compact sizes (from 0402 to 1812) available in reel packing. Inductance values between those listed in this catalog are mostly available on request. Ferrite core versions are also available for selected case sizes for applications which require higher inductances in a smaller case size.

Applications Used in LC resonant circuits such as oscillator and signal generators, impedance matching, RF filters etc.
 Mobile Telecommunication: GSM, CDMA, TCDMA, cordless phones, 2 way radio
 Automotive Subsystems: TPMS, Keyless Entry, Anti-Theft, GPS
 Wireless Communication: W-LAN, WIFI, WIMAX, RFID, Bluetooth
 Non-magnetic versions for medical imaging applications: ASM series

Technical Data

L – Value (rated inductance)	≥ 1 MHz measured with HP 4286A RF LCR meter at frequency f_L < 1 MHz measured with Bode 100 Vector Network Analyzer at frequency f_L
Q – Factor (min)	≥ 1 MHz measured with HP 4287A RF LCR meter at frequency f_Q < 1 MHz measured with Bode 100 Vector Network Analyzer at frequency f_Q
SRF (min)	Measured with HP 8753ES Network Analyzer
DCR (max)	Measured at 25°C
Operating Temperature	For ceramic core from -40°C to +150°C (Including component self-heating) For ferrite core from -40°C to +85°C
Surface Finishing	Epoxy molded flat top for perfect pick and place assembly
Pad Metallization	Gold flash as top layer for AS, AQ, F & AF Silver flash as top layer for ASM
Wire Termination	Spot welding
Recommended soldering method	Reflow
Moisture Sensitivity Levels (MSL)	MSL Level 1, indicating unlimited floor life at ≤ 30°C / 85% relative humidity
Solderability	Using lead free solder (Sn 99.9) at 260°C ± 5°C for 5 ± 0.5 seconds, min 90% solder coverage of metallization Standard: IEC 68-2-20 (Ta)
Resistance to Soldering Heat	Resistant to 260°C ± 5°C for 10 ± 1 seconds Standard: IEC 68-2-20 (Tb)
Resistance to Solvent	Resistant to Isopropyl alcohol for 5 ± 0.5 minutes at 23°C ± 5°C Standard: IEC 68-2-45
Climatic Test	Defined by the following standards IEC 68-2-1 for Cold test: -55°C for 96 hours IEC 68-2-2 for Dry heat test: +85°C for ferrite core and 125°C for ceramic core for 96 hours IEC 60068-2-78 for Humidity test: 40°C at RH 95% for 4 days
Thermal Shock Test	Temperature cycle (ceramic) : -40°C to +125°C to -40°C Temperature cycle (ferrite) : -40°C to +85°C to -40°C Max/Min temperature duration: 15 minutes Temperature transition duration: 5 minutes Cycles: 25 Standard: MIL-STD-202G
Adhesion of Soldered Component (Shear Test)	Components withstand a pushing force of 10N for 10 ± 1 seconds Standard: IEC 60068-2-21, method Ue3
Mechanical Shock	Mil-Std 202 Method 213, Condition C 3 axis, 6 times, total 18 shocks 100 G, 6 ms, half-sine
Vibration	Mil-Std 202 Method 204 20 mins at 5G 10 Hz to 2000 Hz 12 cycles each of 3 orientations

Ordering Code Example: 0402AS-1N0X-YY ➔ **0402AS-1N0K-01**

0402 **AS** - **1N0** **X** - **YY**
 (Case Size) (Core Type) (Inductance Value) (Tolerance) (Packing Code)

Case Sizes - 0402, 0603, 0805, 1008, 1206, 1210, 1812
 Core Type - AS, AQ, ASM (Ceramic), F (Ferrite), AF (Ceramic & Ferrite)
 Tolerances - F (1%), G (2%), A (3%), J (5%), K (10%), M (20%)
 Packing Code - 01, 04, 08 (Taped / Reel)



Chip Inductors for RF Applications / Medical Applications (Wire wound-open)

Packing Specification

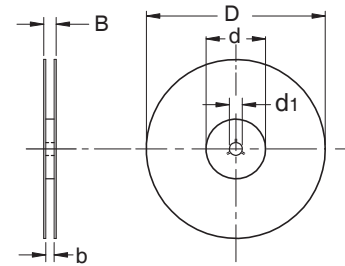
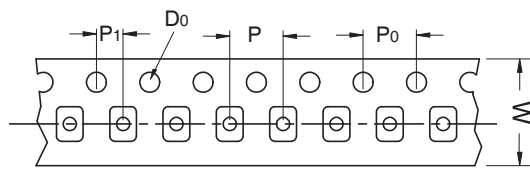
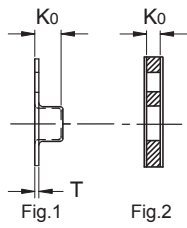

drawing only schematic, see table

Type	Packing Code	D	D ₀	d	d ₁	B	b	W	P	P ₀	P ₁	K ₀	T	Fig
0402	01,08	180	1.55	60	13	12.7	8.4	8	2	4	2	0.6	-	2
0603	01,08	180	1.55	60	13	12.7	8.4	8	4	4	2	0.97	1.05	2
0603	04	330	1.55	100	13	14.4	8.4	8	4	4	2	0.97	1.05	2
0805	01,08	180	1.55	60	13	12.7	8.4	8	4	4	2	1.63	0.25	1
0805	04	330	1.55	100	13	14.4	8.4	8	4	4	2	1.63	0.25	1
1008	01,08	180	1.50	60	13	12.7	8.4	8	4	4	2	2.23	0.3	1
1008	04	330	1.55	100	13	14.4	8.4	8	4	4	2	1.63	0.25	1
1206	01,08	180	1.50	60	13	18.4	13.7	12	4	4	2	1.8	0.3	1
1206	04	330	1.50	100	13	18.4	12.4	12	4	4	2	1.8	0.3	1
1210	01	180	1.55	60	13	18.4	13.7	12	8	4	2	2.55	0.3	1
1210	04	330	1.55	100	13	18.4	12.4	12	8	4	2	2.55	0.3	1
1812	01	180	1.50	60	13	18.4	13.7	12	8	4	2	3.70	0.35	1
1812	04	330	1.50	100	13	18.4	12.4	12	8	4	2	3.70	0.35	1

Packing Specification