



The plastic connector with metal quick mating feature

MBG provides the complete answer to high number of mating cycles

Endurance ■ 5 000 mating/unmating cycles

Rapid and secure locking ■ Locks with audible positive «click»

In accordance with ■ UL file: E238675
CSA certified: LR54977

Complete range of contacts ■ Trim Trio contacts #16

Layout

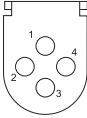
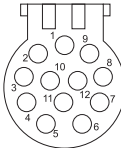
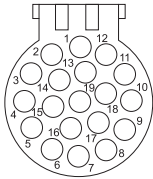
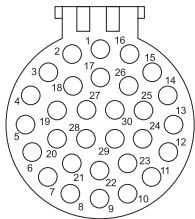
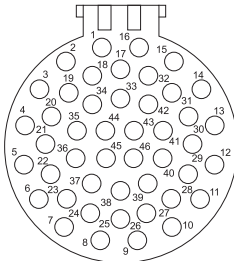
Contacts number	Insert arrangement
4	<p style="text-align: center;">MBG4</p> 
12	<p style="text-align: center;">MBG12</p> 
19	<p style="text-align: center;">MBG19</p> 
30	<p style="text-align: center;">MBG30</p> 
46	<p style="text-align: center;">MBG46</p> 



Specifications

Contacts number*	Part number				
	Plug		Panel mounting receptacle		Strain relief
	For female contacts	For male contacts	For male contacts	For female contacts	
4	MBG4P1	MBG4P11	MBG4R1	MBG4R11	MBG4S1
12	MBG12P1	MBG12P11	MBG12R1	MBG12R11	MBG12S1
19	MBG19P1	MBG19P11	MBG19R1	MBG19R11	MBG19S1
30	MBG30P1	MBG30P11	MBG30R1	MBG30R11	MBG30S1
					MBG30S2
46	MBG46P1	MBG46P11	MBG46R1	MBG46R11	MBG46S1

*Contacts supply separately

Dimensions

Plug - MBG.P.

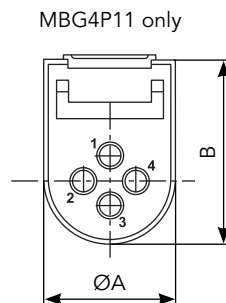
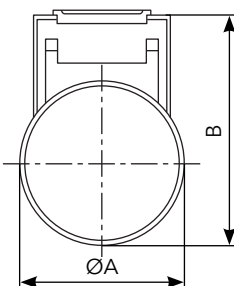
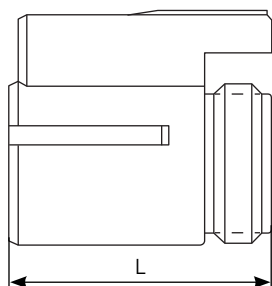

Contacts number	$\text{ØA} \pm 0.25$	$\text{B} \pm 0.25$	L
4	15.08	21.90	30.5
12	19.43	27.25	
19	22.83	30.53	
30	27.94	35.51	
46	34.42	41.91	

Receptacle - MBG.R.

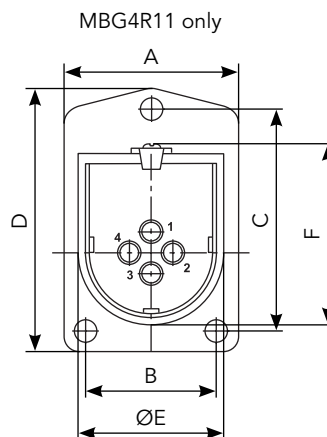
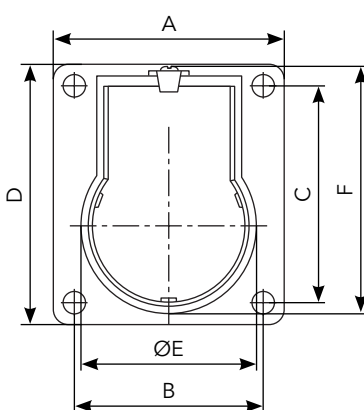
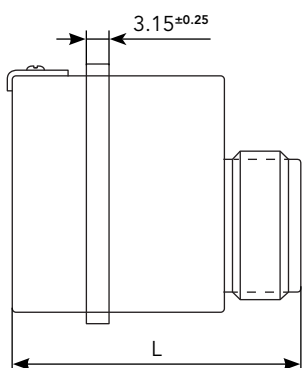

Contacts number	$\text{ØA} \pm 0.25$	B max	$\text{C} \pm 0.18$	$\text{D} \pm 0.30$	$\text{ØE} \pm 0.18$	F max	$\text{L} \pm 0.25$
4	15.08	21.90	31.45	37.36	20.07	29.46	40.2
12	19.43	27.25	30.76	36.86	24.64	34.93	
19	22.83	30.53	34.04	40.13	27.86	38.10	
30	27.94	35.51	38.00	44.91	33.10	43.31	
46	34.42	41.91	46.94	54.05	39.70	49.61	

Note: all dimensions are in mm and for information only

Dimensions

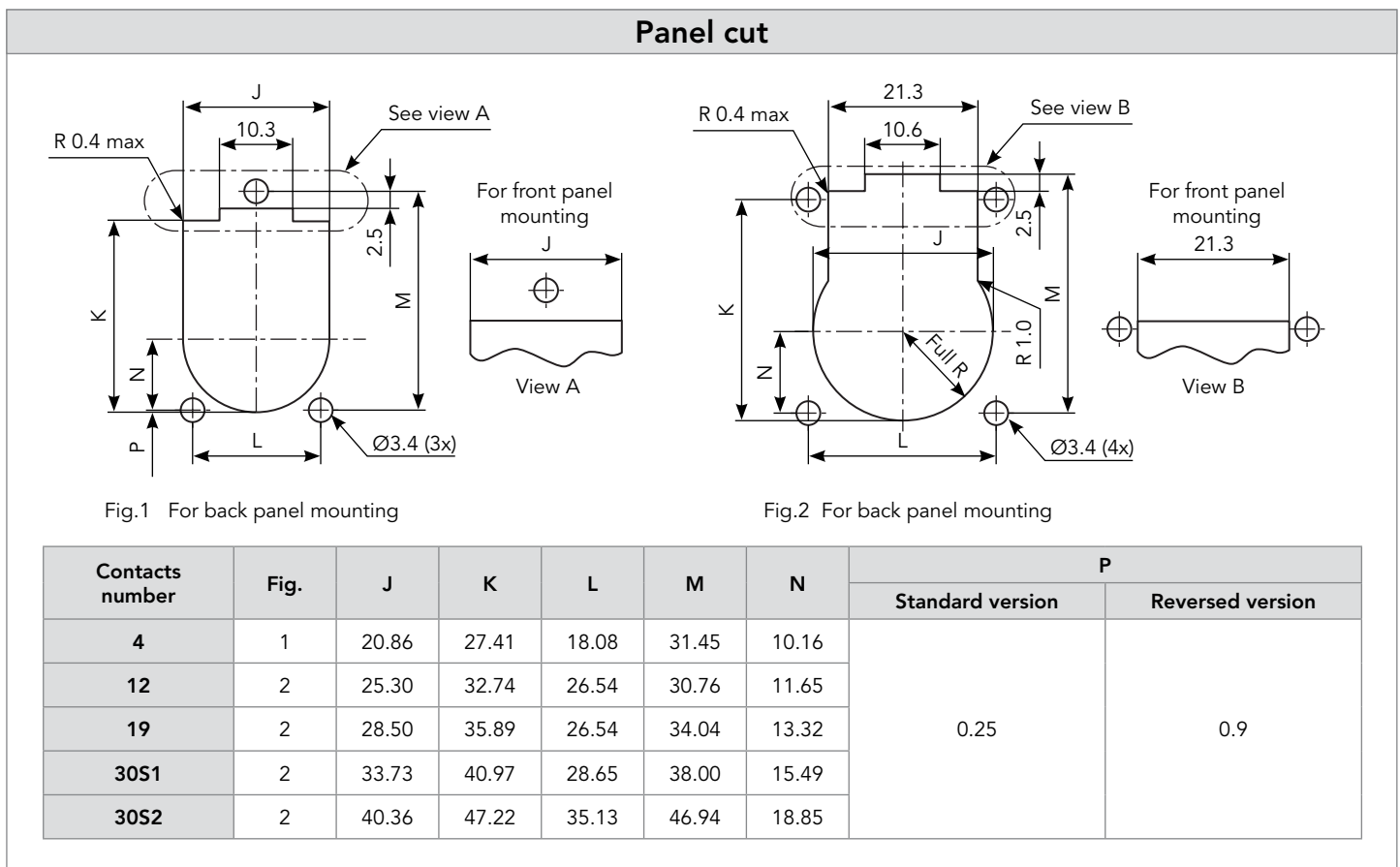
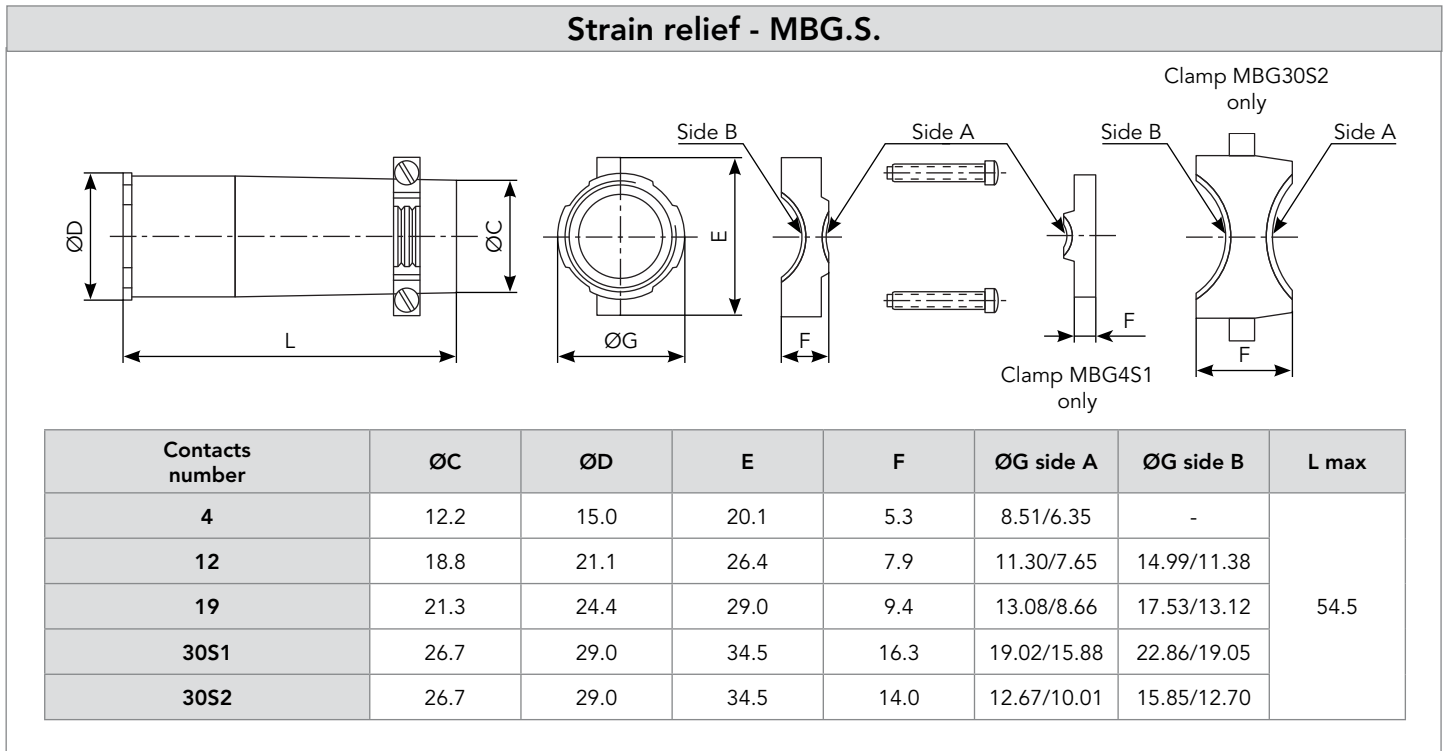

Note: all dimensions are in mm and for information only

Tooling

Handle (without head)



Part number

SHANDLES

Tool kit



Part number

TOOLKIT

Extraction Tool #16



Part number

RX2025GE1

Head Crimp Tooling (without handle)



Contacts	Contact size	Part number of head
RM/RC 28M1K ⁽¹⁾	Standard contacts #16 Ø 1.6mm	S16RCM20*
RM/RC 24M9K ⁽¹⁾		S16RCM20*
RM/RC 20M13K ⁽¹⁾		S16RCM20*
RM/RC 20M12K ⁽¹⁾		S16RCM20*
RM/RC 16M23K ⁽¹⁾		S16RCM16*
RM/RC 14M30K ⁽¹⁾		S16RCM14*
SM/SC 24ML1TK6 ⁽¹⁾		S16SCM20*
SM/SC 20ML1TK6 ⁽¹⁾		S16SCM20*
SM/SC 16ML1TK6 ⁽¹⁾		S16SCML1*
SM/SC 14ML1TK6 ⁽¹⁾		S16SCML1*
SM/SC 16ML11TK6 ⁽¹⁾		S16SCML11*
RMDXK10D28K	Coaxial contacts #16 Ø 1.6mm	M10S1J with die set & stop bushing
RCDXK1D28K		
RM/RC DX60xxD28K		
RM/RC DXK10D28 + york090		
RM/RC DX60xxD28		

(1): Example of plating, for other plating options see page 9
* Heads to be used with handle PN: SHANDLES

(2): loose contact



+



=



Contacts

#16	Contact type	AWG	Part number		Max wire Ø	Max insulator Ø
			Male	Female		
Crimp	Machined	30-28	RM28M1K ⁽¹⁾	RC28M1K ⁽¹⁾	0.55	1.00
		26-24	RM24M9K ⁽¹⁾	RC24M9K ⁽¹⁾	0.80	1.60
		22-20	RM20M13K ⁽¹⁾	RC20M13K ⁽¹⁾	1.15	1.80
		22-20	RM20M12K ⁽¹⁾	RC20M12K ⁽¹⁾	1.15	2.20
		20-16	RM16M23K ⁽¹⁾	RC16M23K ⁽¹⁾	1.80	3.20
		16-14	RM14M30K ⁽¹⁾	RC14M30K ⁽¹⁾	2.30	3.20
	Stamped & Formed Reeled Contacts See note (2) for loose piece	26-24	SM24M1TK6 ⁽¹⁾⁽²⁾	SC24M1TK6 ⁽¹⁾⁽²⁾	-	0.90-1.60
		22-20	SM20M1TK6 ⁽¹⁾⁽²⁾	SC20M1TK6 ⁽¹⁾⁽²⁾	-	1.20-2.10
		18-16	SM16M1TK6 ⁽¹⁾⁽²⁾	SC16M1TK6 ⁽¹⁾⁽²⁾	-	3.20
		18-16	SM16M11TK6 ⁽¹⁾⁽²⁾	SC16M11TK6 ⁽¹⁾⁽²⁾	-	3.00
	14	SM14M1TK6 ⁽¹⁾⁽²⁾	SC14M1TK6 ⁽¹⁾⁽²⁾	-	3.20	
Coaxial	Cable Multipiece	For jacket diameter from 1.78 to 3.05mm Inner conductor up to 2.44mm diameter	RMDXK10D28	RCDXK1D28	-	-
	Cable Monocrimp		RMDX60xxD28	RCDX60xxD28	-	-
	Twisted pair Multipiece	For jacket diameter from 0.64 to 1.45mm Inner conductor from AWG30 to AWG24	RMDXK10D28 + yorK090	RCDXK1D28 + yorK090	-	-
	Twisted pair Monocrimp		RMDX60xxD28	RCDX60xxD28	-	-

(1): Example of plating, for other plating options see page 9

Note: all dimensions are in mm

(2): For loose piece contact packaging, place "L" in part number. Example: SM20ML1TK6

Specific contacts

Contact size	Part number	Hand tools (SHANDLES) head	Tool with separate locator			Extraction tools
			Hand tool	Positioner + locator setting		
#16 Ø 1.6mm Longer RM contact	RM28M1GE1-	S16RCM20				RX2025GE1
	RM24M9GE1-					
	RM20M13GE1-					
	RM16M23 GE1-	S16RCM16	MH860	MH86186	6/8	
	RM14M50 GE1-	S16RCM1450	M317	UH25	3	
RM14M30 GE1-	S16RCM14					
#16 Ø 1.6mm Shorter RC contact	RC28M1GE7-	S16RCM20	MH860	MH86164G	4/6	
	RC24M9GE7-				5/6	
	RC20M13GE7-				5/7	
	RC20M12GE7-				6/8	
	RC16M23GE7-	S16RCM16	M317	UH25	3	
	RC14M50GE7-	S16RCM1450				
	RC14M30GE7-	S16RCM14				

Coaxial contacts

See pages 12

Plating Selector Guide

Contact preloaded

Electrical characteristics: contact resistance		
#16 Ø1.6mm	Machined	< 3mΩ

Available platings (contact preloaded)
Min 0.4μ gold over 2μ Ni

Contact supply separately

Electrical characteristics: contact resistance		
#16 Ø1.6mm	Machined	< 3mΩ
	Stamped & formed	< 6mΩ

Contact size	Available platings options (contacts supplied separately)	
#16	S31	Active part: Gold flash over Ni Crimp area: Nickel
	S18	Active part: 0.75μ gold min over 2μ Ni Crimp area: 1.3μ tin over Ni Other: Nickel
	J	Gold flash over 2μ Ni
	D70	Superseded by S31
	S6	Superseded by S18
Other platings on request (contacts supplied separately)		
#16	T	2μ Ni min all over + 3 to 5μ Sn all over
	D28	0.75μ gold over Ni

Packaging - Size contacts #16

Due to the wide variety of applications, contact packaging is offered for small series (bulk package) and high volume production (reeled contacts):

Stamped & Formed



- 25 pieces loose package

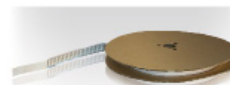

- 3 000 pieces reeled

Machined contacts



- 50 pieces bulk package



- 1 000 pieces bulk package

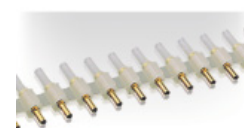

- 2 000 pieces reeled

Note : 1 000 pieces bulk package available by adding 1000 at the end of the part number: e.g. RC16M23K1000
2 000 pieces reeled package available by adding K at the beginning of the part number: e.g. KRC16M23K



Contacts (Continued)

Contact Selector Guide

Contact size	Type	Wire size		Part number		Max wire Ø	Max insulator Ø	Available plating see page 9
		AWG	mm ²	Male	Female			
#16 Ø1.6 mm	Machined	30-28	0.05-0.08	RM28M1-	RC28M1-	0.55	1.00	K, J
	Machined	26-24	0.13-0.2	RM24M9-	RC24M9-	0.80	1.60	K, J
	Stamped & Formed	26-24	0.13-0.25	SM24M1- ⁽¹⁾ SM24ML1- ⁽²⁾	SC24M1- ⁽¹⁾ SC24ML1- ⁽²⁾	0.89-1.28	Insulation grip	TK6, S31, S18
	Machined	22-20	0.32-0.52	RM20M13-	RC20M13-	1.15	1.80	K, J
				RM20M12-	RC20M12-		2.20	
	Stamped & Formed	22-20	0.35-0.5	SM20M1- ⁽¹⁾ SM20ML1- ⁽²⁾	SC20M1- ⁽¹⁾ SC20ML1- ⁽²⁾	1.17-2.08	Insulation grip	TK6, S31, S18
	Machined	20-16	0.52-1.5	RM16M23-	RC16M23-	1.80	3.20	K, J
	Stamped & Formed	18-16	0.8-1.5	SM16M1- ⁽¹⁾ SM16ML1- ⁽²⁾	SC16M1- ⁽¹⁾ SC16ML1- ⁽²⁾	3.00	No insulation grip	TK6, S31, S18
	Stamped & Formed	18-16	0.8-1.5	SM16M11- ⁽¹⁾ SM16ML11- ⁽²⁾	SC16M11- ⁽¹⁾ SC16ML11- ⁽²⁾	2.00-3.00	Insulation grip	TK6, S31, S18
	Machined	16-14	1.5-2.5	RM14M30-	RC14M30-	2.30	3.20	K, J
Stamped & Formed	14	2.0-2.5	SM14M1- ⁽¹⁾ SM14ML1- ⁽²⁾	SC14M1- ⁽¹⁾ SC14ML1- ⁽²⁾	3.20	No insulation grip	TK6, S31, S18	

(1) contact reeled (2) loose contact
 Example: **RM16M3K** - Size #16, Machined, AWG20 wire, gold plating.

Wire Stripping Length

	Part number		Stripping length L (mm)
	Male	Female	
Machined contact	#16 - Ø 1.6mm		
	RM28M1- / RM24M9- RM20M13- / RM20M12-	RC28M1- / RC24M9- RC20M13- / RC20M12-	4.8
	RM16M23- / RM14M30-	RC16M23- / RC14M30-	7.1
Stamped & formed	#16 - Ø 1.6mm		
With insulation support 	SM24M1- / SM24ML1- SM20M1- / SM20ML1-	SC24M1- / SC24ML1- SC20M1- / SC20ML1-	4
	SM16M11- / SM16ML11-	SC16M11- / SC16ML11-	4.65
Without insulation support 	#16 - Ø 1.6mm		
	SM16M1- / SM16ML1-	SC16M1- / SC16ML1-	6.35
	SM14M1- / SM14ML1-	SC14M1- / SC14ML1-	6.35

Note: Assembly operations mentioned above shall not interfere or to be in contradiction with the IPC-WHMA-A-620B

Note: all dimensions are in mm

First Mate Last Break Contacts

Contact size	Type	Wire size		Part number		Max wire Ø (mm)	Max insulator Ø (mm)	Color band		Available plating see p. 9
		AWG	mm ²	Male	Female			Front	Rear	
#16 Ø1.6 mm Longer male contact (+1mm)	Machined	30-28	0.05-0.08	RM28M1GE1-	-	0.55	1.1	-	Red	KorJ
		26-24	0.13-0.2	RM24M9GE1-		0.8	1.6	Red	Red	
		22-20	0.32-0.52	RM20M13GE1-		1.18	1.8	Black	Red	
				RM20M12GE1-			2.2	Blue	Red	
		20-16	0.52-1.5	RM16M23GE1-		1.8	3.2	-	Red	
		16-14	1.5-2.5	RM14M30GE1-		2.28	-	-	Red	
#16 Ø1.6 mm Shorter female contact (-0.7mm)	Machined	30-28	0.05-0.08	-	RC28M1GE7-	0.55	1.1	-	Blue	KorJ
		26-24	0.13-0.2		RC24M9GE7-	0.8	1.6	Red	Blue	
		22-20	0.32-0.52		RC20M13GE7-	1.18	1.8	Black	Blue	
					RC20M12GE7-		2.2	Blue	Blue	
		20-16	0.52-1.5		RC16M23GE7-	1.8	3.2	-	Blue	
		16-14	1.5-2.5		RC14M30GE7-	2.28	-	-	Blue	

How to Make FMLB / LMFB Connection

Contact 1 \ Contact 2	Standard male contact	Standard female contact	Longer male contact
Standard male contact		✓	
Standard female contact	✓		✓ FMLB
Shorter female contact	✓ LMFB		

First Mate Last Break contacts should be chosen only if the cavity is not marked with the ground symbol. For cavities marked with the ground symbol, standard contacts will fulfill the same role as a first mate, last break contact used in a standard cavity.



Ground symbol

#16 Coaxial Contacts

Coaxial Contact Range

We provide 2 types of coaxial contacts suitable for 50 or 75Ω, coaxial cable or twisted pair cable.

Monocrimp Coaxial Contact

- The monocrimp one-piece coaxial contacts offer high reliability plus the economic advantage of a 95% reduction in installation time over conventional assembly methods.
- This economy is achieved by simultaneously crimping both the inner conductor and outer braid or drain wire.



Multipiece Crimp Coaxial Contact

- The inner conductor and outer braid is crimped individually.
- The thermoplastic insulating bushing in the outer body is designed to accept and permanently retain the inner contact.
- An outer ferrule is used to connect the braid to the outer contact and provide cable support to ensure against bending and vibration.



Suitable for Coaxial Cable or Twisted Cable

- For jacket diameter from 1.78 to 3.05mm
Inner conductor up to 2.44mm diameter



- For jacket diameter from 0.64 to 1.45mm
Inner conductor from AWG30 to AWG24

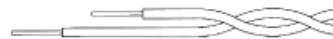

Contacts for Coaxial Cable Summary

Contact type	Contact range		Contact part number with cable combination	Cabling notice
	Male contact	Female contact		
Multipiece	RMDXK10D28	RCDXK1D28	See page 13	See pages 17 & 18
Monocrimp	RMDX60xxD28	RCDX60xxD28		See page 19

Contacts for Twisted Pairs Cable Summary

Contact type	Contact range		Contact part number with cable combination	Cabling notice
	Male contact	Female contact		
Multipiece	RMDXK10D28 + YORK090	RCDXK1D28 + YORK090	See page 14	See page 15
Monocrimp	RMDX60xxD28	RCDX60xxD28		See page 16

Coaxial Cable - Contact Monocrimp and Multipiece

Cable type	Impedance Ω	Contact type	\varnothing over jacket		\varnothing over dielectric		Inner cond size Ext. \varnothing mm	\varnothing outer braid		Male contact kit for coaxial cable	Female contact kit for coaxial cable
			inch	mm	inch	mm		inch	mm		
RG161/U	75	Multi piece	0.09"	2.29	0.057"	1.45	-	-	-	RMDXK10D28	RCDXK1D28
RG179A/U	75		0.105"	2.67	0.063"	1.6	0.3	0.084"	2.13 max		
RG179B/U	75		0.105"	2.67	0.063"	1.6	0.3	0.084"	2.13 max		
RG187/U	75		0.11"	2.79 max	0.06"	1.52	0.3				
RG188/U	50		0.11"	2.79 max	0.06"	1.52	0.51	0.078"	1.98 max		
RG174/U	50		0.11"	2.92	0.06"	1.52	0.48	0.088"	2.24 max		
AMPHENOL 21-598	50		0.105"	2.67	0.06"	1.52	0.48	-	-		
RG196/U	50		0.08"	2.03 max	0.034"	0.086	0.3	-	--		
RG178A/U	50		0.075"	1.91	0.034"	0.86	0.3	0.054"	1.37 max		
RG/188A/U	50	Mono crimp	0.110"	2.79	0.06"	1.52	0.51	0.078"	1.98 max	RMDX6036D28	RCDX6036D28
KX21TVT (europe) RG178 B/U	50		0.075"	1.91	0.034"	0.86	0.3	0.054"	1.37 max	RMDX6034D28	RCDX6034D28
RG178 / BU	50		0.075"	1.91	0.034"	0.86	0.3	0.054"	1.37 max	RMDX6050D28	RCDX6016D28
RG174/U	50		0.115"	2.92	0.06"	1.52	0.48	0.088"	2.24 max	RMDX6032D28	RCDX6032D28
RG188A/U	50		0.11"	2.79	0.06"	1.52	0.51	0.078"	1.98 max	RMDX6036D28	RCDX6036D28
RG316/U	50		0.107"	2.72	0.06"	1.52	0.51	0.078"	2.05 max	RMDX6036D28	RCDX6036D28
raychem 5024A3111	50		0.12"	3.05	0.083"	2.11	0.64	0.097"	2.46	RMDX6052D28	RCDX6052D28
raychem 5026e1614	50		0.083"	2.11	0.05"	1.27	0.48	0.067"	1.7	RMDX6036D28	RCDX6036D28
surprenant pn 8134	-		Multi piece	0.1"	2.54	0.058"	1.47	0.3	-	-	RMDXK10D28
PRD PN 247AS-C1123-001	-	Mono crimp	0.103"	2.62	0.06"	1.52	0.51	0.078"	1.98	RMDX6018D28	RCDX6018D28
PRD PN 247AS-C1251	-		0.092"	2.34	0.05"	1.27	0.64	0.067"	1.7	RMDX6018D28	RCDX6018D28
JUDD C15013010902	-		0.087"	2.13	0.05"	1.27	0.48	0.066"	1.67	RMDX6036D28	RCDX6036D28
CDC PIN22939200	-		0.09"	2.29	0.048"	1.22	0.3	0.064"	1.63	RMDX6046D28	RCDX6016D28
CDC PIN22939200	-		0.09"	2.29	0.048"	1.22	0.3	0.064"	1.63	RMDX6050D28	RCDX6016D28
CDC PIN245670000	-		0.104"	2.64	0.067"	1.7	0.3	0.083"	2.11	RMDX6050D28	RCDX6016D28
ampex	-		0.114"	2.9	0.075"	1.91	0.38	0.09"	1.29	RMDX6032D28	RCDX6032D28
TI PN 920580	-		0.7"	1.78	0.038"	0.96	0.48	0.054v	1.37	RMDX6024D28	RCDX6024D28
Honeywell PN 58000062	-		0.12"	3.05	0.077"	1.96	0.41 solid	0.096"	2.44	RMDX6026D28	RCDX6026D28
-	-		0.104"	2.64	0.067"	1.7	0.3	-	2.11	RMDX6050D28	-
-	-		0.09"	2.29	0.048"	1.22	0.3	-	1.63	RMDX6050D28	-
-	-		0.114"	2.9	0.075"	1.91	0.38	-	1.29	RMDX6032D28	RCDX6032D28
-	-		0.07"	1.78	0.038"	0.96	0.48	-	1.37	RMDX6024D28	RCDX6024D28
-	-	0.12"	3.05	0.077"	1.96	0.41	-	2.44	RMDX6026D28	RCDX6026D28	

#16 Coaxial Contacts (Continued)

Twisted Cable - Contact Monocrimp and Multipiece

Cable type	Contact type	Inner AWG cond	Ø over jacket (single wire)		Inner cond size		Ø outer braid		Male contact kit for coaxial cable	Female contact kit for coaxial cable
			inch	mm	Stranded definition	Ext. Ø mm	inch	mm		
2#24 stranded MIL-W-16878 type B	Multi piece	24	0.049"	1.24 max	7/.008		-	-	RMDXK10D28	RCDXK1D28
2 #24 solid MIL-W-76 type LW		24	0.047"	1.12 max	1/.0201		-	-	RMDXK10D28	RCDXK1D28
2 #26 stranded MIL-W-76 type LW or MIL-W-16878 type B&E		26	0.043"	1.09 max	7/.0063	0.16	-	-	RMDXK10D28	RCDXK1D28
2 #28 solid MIL-W-81822/3		28	0.028"	0.71 max			-	-	RMDXK10D28	RCDXK1D28
Twisted pair 1/.201 solid MIL-W-76 type LW or MIL-W-16878		26	0.044"	1.12 max	1/.0201	0.511	-	-	RMDXK10D28	RCDXK1D28
Twisted pair solid MIL-W-81822/3		28	0.028"	0.71 max	1/.0126	0.32	-	-	RMDXK10D28	RCDXK1D28
#28 7/.0036 per Hitachi spec ec-711 (13-2820)	Mono crimp	-	0.046"	1.17	7/.0036	-	-	-	RMDX6031D28 + YORX090	RCDX6031D28 + YORX090
20218201		-	0.028"	0.71	-	-	-	-	RMDX6031D28 + YORX090	RCDX6031D28 + YORX090
#30 solid		-	0.025"	0.64	-	-	-	-	RMDX6015D28 + YORX090	RCDX6015D28 + YORX090
#26 7/.0063		26	0.028"	0.71	7/.063	0.16	-	-	RMDX6031D28 + YORX090	RCDX6031D28 + YORX090
#26 19/.004		26	0.049"	1.24	19/.004	-	-	-	RMDX6019D28 + YORX090	RCDX6019D28 + YORX090
#24 7/.008		24	0.049"	1.24	7/.008	-	-	-	RMDX6019D28 + YORX090	RCDX6019D28 + YORX090
#24 19/.005		24	0.057"	1.45	19/.005	-	-	-	RMDX6019D28 + YORX090	RCDX6019D28 + YORX090
-		26	-	1.25	-	-	-	19x0.1	RMDX6019D28 + YORX090	RCDX6019D28 + YORX090
-		24	-	1.25	-	-	-	7x0.2	RMDX6019D28 + YORX090	RCDX6019D28 + YORX090
-		24	-	1.45	-	-	-	19x0.13	RMDX6019D28 + YORX090	RCDX6019D28 + YORX090
-		26	-	0.7	-	-	-	7x0.16	RMDX6031D28 + YORX090	RCDX6031D28 + YORX090

Twisted Pair Cable Multipiece Contact Cabling

Cable reference	Contact type	Male contact	Female contact	Crimp tool	Die set	Stop bushing	Cable strip length			Inner conductor crimp		Braid crimp	
							A	B	C	g dim	t dim	g dim	t dim
2#24 stranded mil w 16878 type B	Multi piece	RMDXK10D28	RCDXK1D28	M10S1J	-	-				See assembly notice			
2 #24 solid mil-w-76 type LW													
2 #26 stranded mil w 76 type LW or mil w16878 type B & E													
2 #28 solid mil-w-81822/3													
twisted pair 1/.201 solid mil w 76 type LW or mil w 16878													
twisted pair solid mil w 81822/3													

Female contact

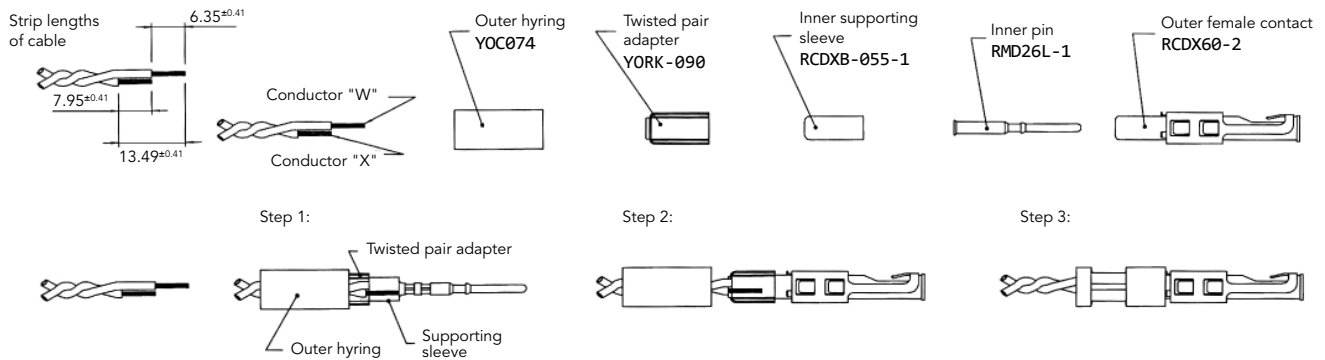

Male contact

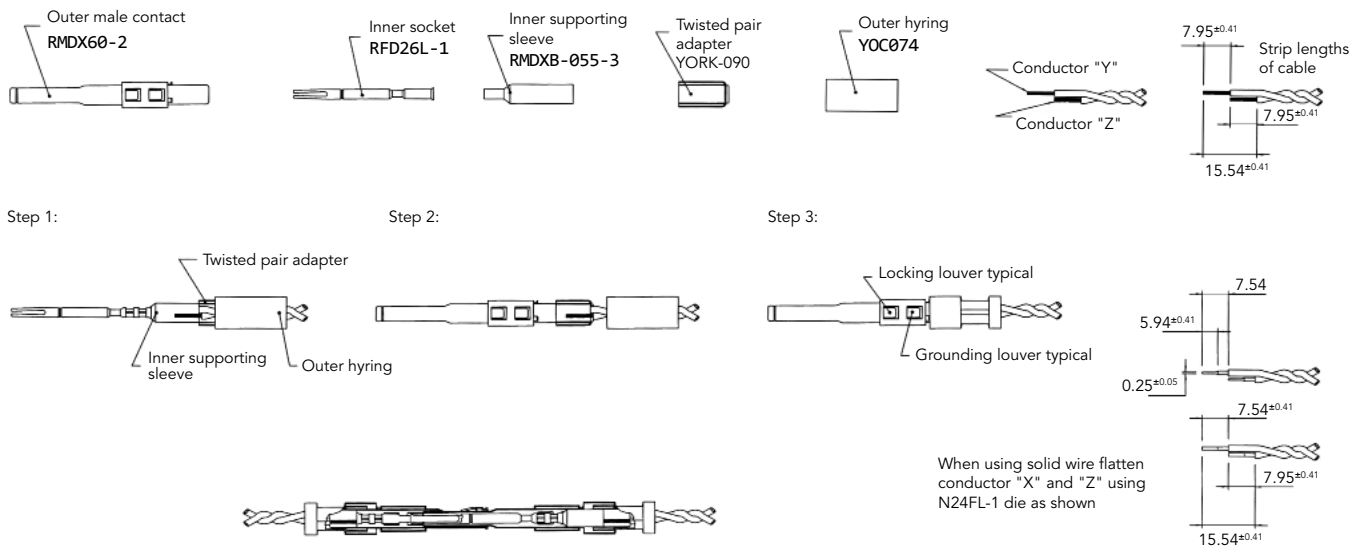

Note : all dimensions are in mm

#16 Coaxial Contacts (Continued)

Twisted Pair Cable Monocrimp Contact Cabling

Cable reference	Contact type	Male contact	Female contact	Crimp tool	Die set	Stop bushing	Cable strip length			Inner conductor crimp		Braid crimp	
							A	B	C	g dim	t dim	g dim	t dim
#28 7/.0036 per Hitachi spec ec-711 (13-2820)	Mono crimp	RMDX6031D28 + YORX090	RCDX6031D28 + YORX090	M10S1J	S80	SL105	4.7	6.1	4.32	1.30 to 1.12	1.4 to 1.22	2.97 to 2.84	3.07 to 2.9
20218204							3.94	6.1	3.16	1.30 to 1.17	1.4 to 1.22	2.97 to 2.84	3.07 to 2.79
#30 solid							4.7	6.1	4.06	1.22 to 1.12	1.35 to 1.22	2.97 to 2.84	3.12 to 2.95
#26 7/.0063							4.7	6.1	4.06	1.30 to 1.17	1.4 to 1.22	2.97 to 2.84	3.07 to 2.9
#26 19/.004							4.7	6.1	4.06	1.22 to 1.17	1.35 to 1.22	2.84 to 2.79	3.12 to 2.97
#24 7/.008							4.7	6.1	4.06	1.22 to 1.17	1.35 to 1.22	2.84 to 2.79	3.12 to 2.97
#24 19/.005							4.7	6.1	4.06	1.22 to 1.17	1.35 to 1.22	2.84 to 2.79	3.12 to 2.97
AWG26 (19x0.1)							M10S68 crimping kit	4	4	/	/	/	/
AWG24 (7x0.2)													
AWG24 (19x0.13)													
AWG26 (7x0.16)													

- Select appropriate monocrimp coax twisted pair contact and cable combination.
- Select appropriate crimp tooling (hand tool, S-die set, stop bushing).
- Strip the twisted pair cable to the designated wire strip lengths.
- Insert the stripped cable into the contact. One cable is to be inserted into the inside diameter of hyring, and pushed forward into the inner contact. The second cable is to be inserted between the outside diameter of hyring and the inside diameter of the outer contact body.
- Crimp the contact.

Cable strip length

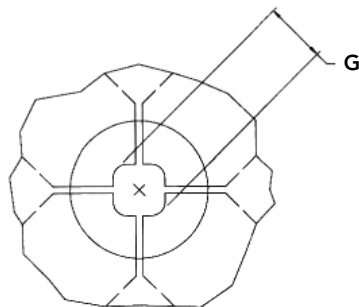
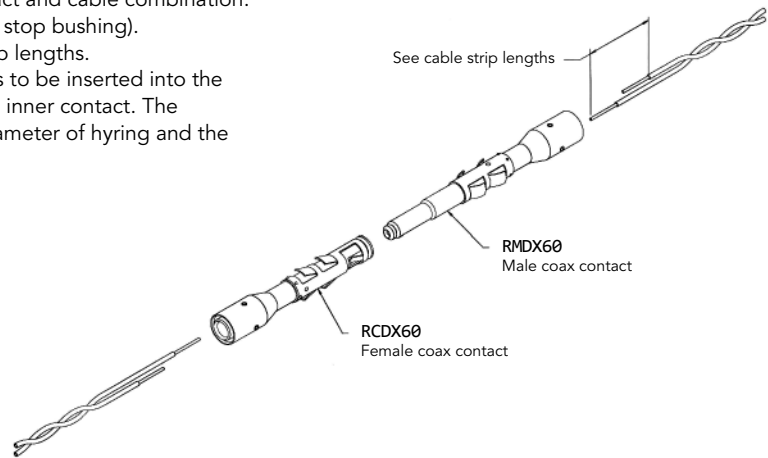
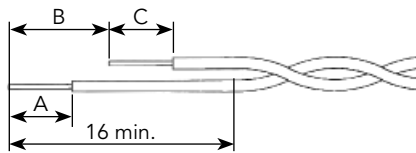

Braid crimp (G) to be measured with die set fully closed

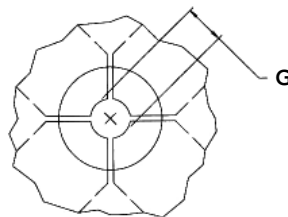

Inner conductor crimp (G) to be measured with die set fully closed

Multipiece Male Contact with Coax Cable

Cable reference	Contact	Hyring complementary compoments	Outer contact crimp tool		Inner contact crimp tool		Cable strip length		
			Crimp tool M10S1J		Crimp tool M10S1J		A	B	C
			Die set	Stop bushing	Die set	Stop bushing			
RG161U	Male: RMDXK10D28	YOC074	S221	SL471	S23D2	SL46D2	4.37	7.95	15.88
RG179							4.37	7.95	15.88
RG187U							4.37	7.95	15.88
RG188/U							4.37	7.95	15.88
RG174/U		YOC074 + RMDXB0553			S23D2		7.54	9.12	17.53
RG178A/U							7.54	9.12	17.53
RG196U							-	4.37	7.95
AMPHENOL 21-598		YOC074			-		4.37	7.95	15.88
surprenant pn 8134							-	4.37	7.95

Multipiece kit details

RMDXK10D28 includes	RMDX602D28	Outer contact
	RFD26L1D28	Inner contact
	YOC074	Outer hyring
	RMDXB0553	Inner supporting sleeve

Cable strip length

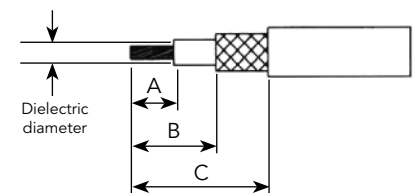

Contact assembly with dielectric diameter over 1.4mm - without inner supporting sleeve

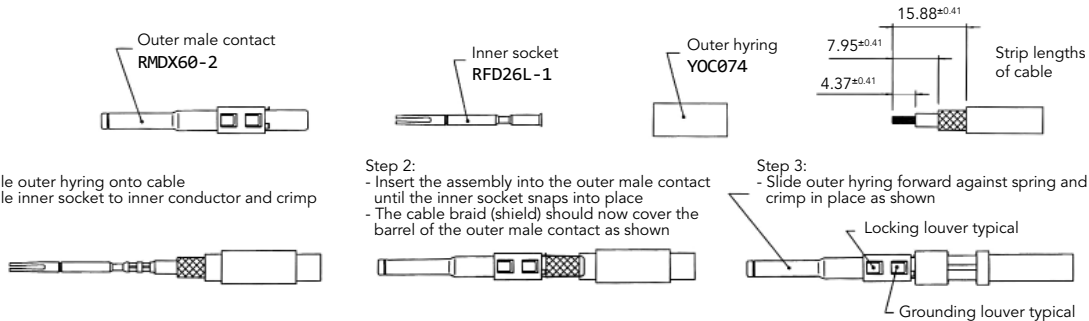

Contact assembly with dielectric diameter under 1.4mm - with inner supporting sleeve

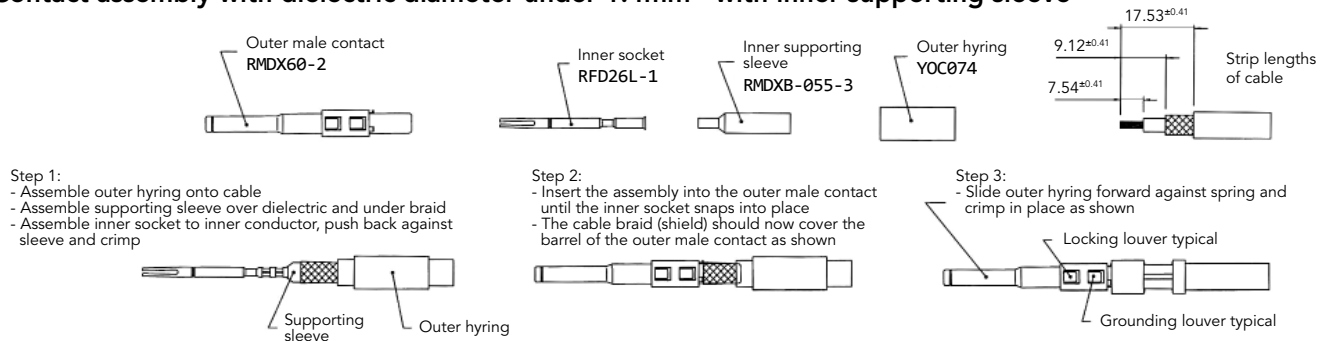

Note : all dimensions are in mm

#16 Coaxial Contacts (Continued)

Multipiece Female Contact with Coax Cable

Cable reference	Contact	Hyring complementary components	Outer contact crimp tool		Inner contact crimp tool		Cable strip length		
			Crimp tool M10S1J		Crimp tool M10S1J				
			Die set	Stop bushing	Die set	Stop bushing	A	B	C
RG161U	Female: RCDXK1D28	YOC074	S221	SL471	S23D2	SL46D2	4.37	-	11.13
RG179							4.37		11.13
RG187U							4.37		11.13
RG188/U							4.37		11.13
RG174/U		YOC074 + RMDXB0553			4.37		11.13		
RG178A/U					6.35		11.13		
RG196U					6.35		11.13		
AMPHENOL 21-598		YOC074			-		4.37		11.13
surprenant pn 8134					-		4.37		11.13

Multipiece kit details

RCDXK1D28 includes	Component	Description
	RCDX602D28	Outer contact
	RMD26L1D28	Inner contact
	YOC074	Outer hyring
	RCDXB0553	Inner supporting sleeve

Cable strip length

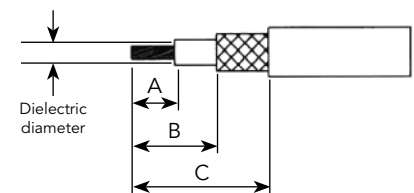

Contact assembly with dielectric diameter over 1.4mm - without inner supporting sleeve

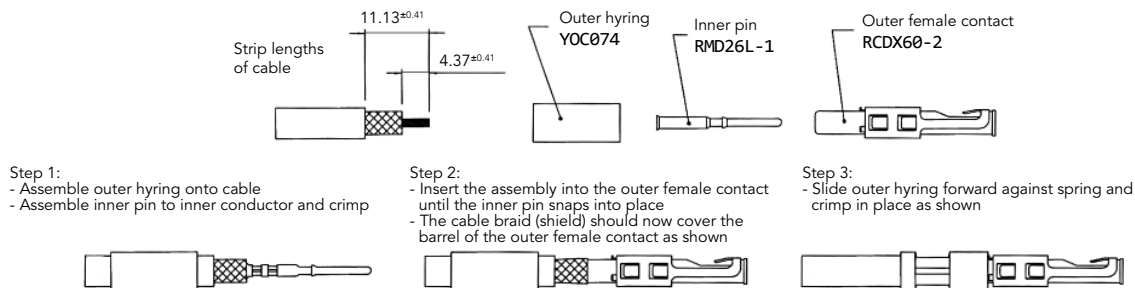

Contact assembly with dielectric diameter under 1.4mm - with inner supporting sleeve

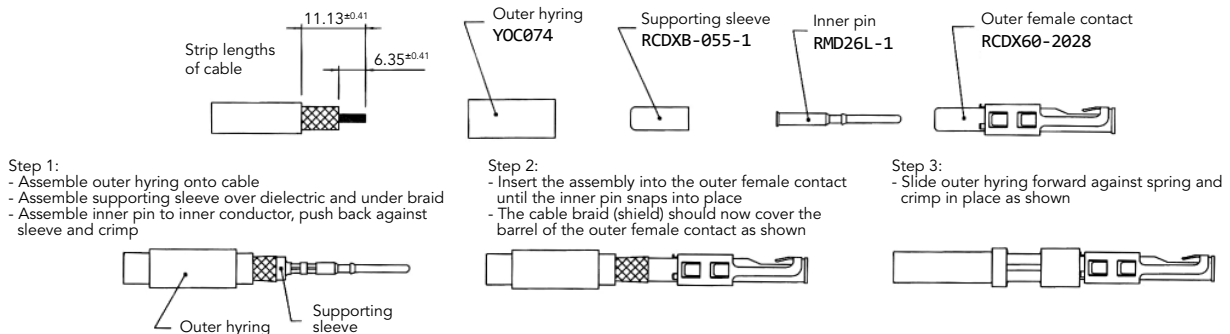

Note : all dimensions are in mm

Coax Cable with Monocrimp Contact Cabling

Cable reference	Male contact	Female contact	Crimp tool	Die set	Stop bushing	Cable strip length			Inner conductor crimp		Braid crimp		
						A	B	C	g dim	t dim	g dim	t dim	
CDC PIN22939200	RMDX6046D28	RCDX6016D28	M1051J	S80	SL105	4.19	5.97	8.51	1.30/1.17	1.40/1.22	2.77/2.64	3.02/2.84	
CDC PIN22939200	RMDX6046D28	RCDX6016D28		S87	SL105	5.08	6.35	8.89	1.30/1.17	1.40/1.22	2.77/2.64	3.02/2.84	
CDC PIN245670000	RMDX6050D28	RCDX6016D28		S80	SL105	5.08	6.35	8.89	1.30/1.17	1.40/1.22	2.97/2.84	3.12/2.95	
KX21TVT (europe) RG178 B/U	RMDX6034D28	RCDX6034D28		S82	SL105	5.08	6.35	8.89	1.30/1.17	1.32/1.17	2.84/2.74	3.07/2.9	
RG178 / BU	RMDX6050D28	RCDX6016D28		S87	SL105	5.08	6.35	8.89	1.30/1.17	1.40/1.22	2.77/2.64	3.02/2.84	
ampex	RMDX6032D28	RCDX6032D28		S80	SL105	5.08	6.35	11.68	1.30/1.17	1.40/1.22	2.97/2.84	3.12/2.95	
TI PN 920580	RMDX6024D28	RCDX6024D28		S82	SL105	5.08	6.35	8.89	1.35/1.19	1.42/1.27	2.87/2.74	3.07/2.9	
RG174/U	RMDX6032D28	RCDX6032D28		S80	SL105	5.08	6.35	11.68	1.30/1.17	1.40/1.22	2.97/2.84	3.12/2.95	
Honeywell PN 58000062	RMDX6026D28	RCDX6026D28		S82	SL105	5.08	6.35	8.89	1.35/1.19	1.42/1.27	2.87/2.74	3.07/2.9	
RG188A/U	RMDX6036D28	RCDX6036D28		S80	SL105	5.08	6.35	11.68	1.30/1.17	1.40/1.22	2.97/2.84	3.12/2.95	
RG316/U	RMDX6036D28	RCDX6036D28		S80	SL105	5.08	6.35	11.68	1.30/1.17	1.40/1.22	2.97/2.84	3.12/2.95	
PRD PN 247AS-C1123-001	RMDX6018D28	RCDX6018D28		M105G8 ASSY'Y TOOL DIE SET STOP BUSHING M1051J TOOL			5.08	6.35	8.89	1.22/1.17	1.35/1.22	2.92/2.79	3.12/2.97
PRD PN 247AS-C1251	RMDX6018D28	RCDX6018D28					5.08	6.35	8.89	1.22/1.17	1.35/1.22	2.92/2.79	3.12/2.97
raychem 5024A3111	RMDX6052D28	RCDX6052D28		S88	SL105	5.08	6.35	11.68	1.37/1.27	1.45/1.32	2.92/2.79		
raychem 5026e1614	RMDX6036D28	RCDX6036D28		M105G8 ASSY'Y TOOL DIE SET STOP BUSHING M1051J TOOL			5.08	6.35	8.89	1.22/1.17	1.35/1.22	2.92/2.79	3.12/2.97
JUDD C15013010902	RMDX6036D28	RCDX6036D28					5.08	6.35	8.89	1.22/1.17	1.35/1.22	2.92/2.79	3.12/2.97
inner cond. #30, braid diam 2.64	RMDX6050D28	-		S80	SL105	5.1	6.35	8.9	-	-	-	-	
inner cond. #30, braid diam 2.29	RMDX6050D28	-		S87	SL105	4.2	6.35	8.5	-	-	-	-	
inner cond. #28, braid diam 2.9	RMDX6032D28	RCDX6032D28		S80	SL105	5.1	6.35	11.7	-	-	-	-	
inner cond. #26, braid diam 1.78	RMDX6024D28	RCDX6024D28		S82	SL105	5.1	6.35	8.9	-	-	-	-	
inner cond. #26, braid diam 3.05	RMDX6026D28	RCDX6026D28	S82	SL105	5.1	6.35	8.9	-	-	-	-		

- Select appropriate cable and contact combination.
- Select appropriate crimp tooling (hand tool, S-die set, stop bushing).
- Strip coax cable to the designated wire strip lengths.
- Insert the stripped coax into the rear of the contact.
- Crimp the contact.

Cable strip length

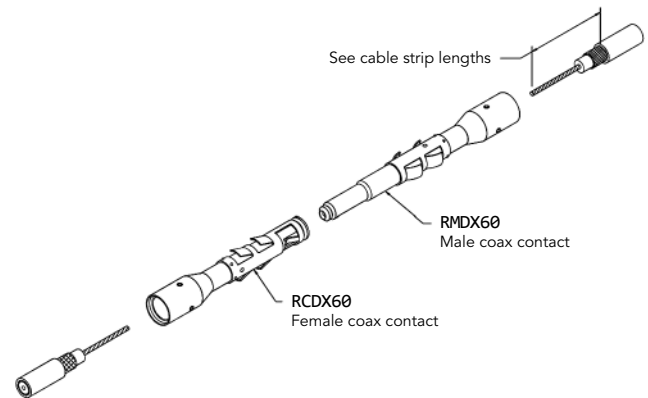
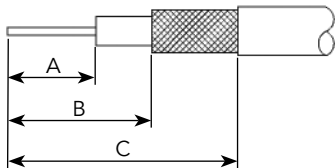

Note : all dimensions are in mm

Handle & Interchangeable Heads

Crimping with SOURIAU Tooling

- 1) Fully close then release the tool, keep it open. Open the 2 pins.



- 2) Choose the adapter head (sold separately), keep vertical and slide it into the handle until the mechanical end.



- 3) Close the two pins simultaneously to maintain the head.



- 4) Strip the cable properly check the recommended size in the catalog on page 10.

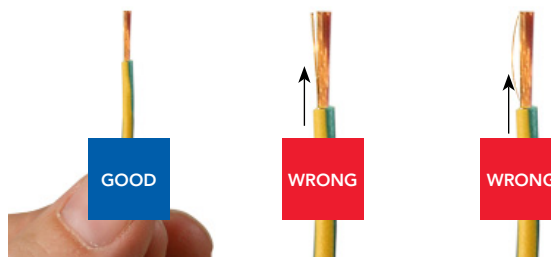

- 5) Place conductors, with no deterioration, in the contact bucket. All strands to be located in the crimp bucket.



- 6) Position the contact in the bottom of the tool by checking its orientation. Maintain the wire in position.



- 7) Tighten sharply the handles to the end of the mechanism (max 175 N). After handles are opened, extract the contact.



- 8) Control the quality of crimping.

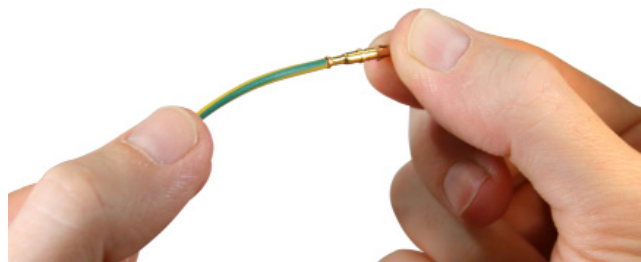

Note: Assembly operations mentioned above shall not interfere or to be in contradiction with the IPC-WHMA-A-620B

For further information contact us at contactindustry@souriau.com
or visit our web site www.souriau-industrial.com

Mouser Electronics

Authorized Distributor

Click to View Pricing, Inventory, Delivery & Lifecycle Information:

Souriau:

[MBG12R1](#) [MBG12P1](#) [MBG12S1](#) [MBG19R1](#) [MBG19P-11](#) [MBG19P1](#) [MBG4P1](#) [MBG4S1](#) [MBG30S2](#) [MBG30S1](#)
[MBG12P-11](#) [MBG12R-11](#) [MBG46R-11](#) [MBG30R11](#) [MBG19R11](#) [MBG30P11](#) [MBG30R1](#) [MBG46P1](#) [MBG46R1](#)
[MBG4P11](#) [MBG4R11](#) [MBG4R1](#) [MBG46P-11](#)