

# TLV2450, TLV2451, TLV2452, TLV2453, TLV2454, TLV2455, TLV245xA FAMILY OF 23- $\mu$ A 220-kHz RAIL-TO-RAIL INPUT/OUTPUT OPERATIONAL AMPLIFIERS WITH SHUTDOWN

SLOS218F – DECEMBER 1998 – REVISED JANUARY 2005

- Supply Current . . . 23  $\mu$ A/Channel
- Gain-Bandwidth Product . . . 220 kHz
- Output Drive Capability . . .  $\pm 10$  mA
- Input Offset Voltage . . . 20  $\mu$ V (typ)
- $V_{DD}$  Range . . . 2.7 V to 6 V
- Power Supply Rejection Ratio . . . 106 dB
- Ultralow-Power Shutdown Mode  
 $I_{DD}$  . . . 16 nA/ch
- Rail-To-Rail Input/Output (RRIO)
- Ultrasmall Packaging
  - 5 or 6 Pin SOT-23 (TLV2450/1)
  - 8 or 10 Pin MSOP (TLV2452/3)

Operational Amplifier

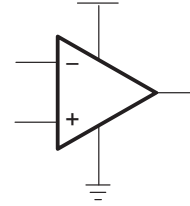

## description

The TLV245x is a family of rail-to-rail input/output operational amplifiers that sets a new performance point for supply current and ac performance. These devices consume a mere 23  $\mu$ A/channel while offering 220 kHz of gain-bandwidth product, much higher than competitive devices with similar supply current levels. Along with increased ac performance, the amplifier provides high output drive capability, solving a major shortcoming of older micropower rail-to-rail input/output operational amplifiers. The TLV245x can swing to within 250 mV of each supply rail while driving a 2.5-mA load. Both the inputs and outputs swing rail-to-rail for increased dynamic range in low-voltage applications. This performance makes the TLV245x family ideal for portable medical equipment, patient monitoring systems, and data acquisition circuits.

FAMILY PACKAGE TABLE

DEVICE	NUMBER OF CHANNELS	PACKAGE TYPES					SHUTDOWN	UNIVERSAL EVM BOARD
		PDIP	SOIC	SOT-23	TSSOP	MSOP		
TLV2450	1	8	8	6	—	—	Yes	Refer to the EVM Selection Guide (Lit# SLOU060)
TLV2451	1	8	8	5	—	—	—	
TLV2452	2	8	8	—	—	8	—	
TLV2453	2	14	14	—	—	10	Yes	
TLV2454	4	14	14	—	14	—	—	
TLV2455	4	16	16	—	16	—	Yes	

A SELECTION OF SINGLE-SUPPLY OPERATIONAL AMPLIFIER PRODUCTS†

DEVICE	$V_{DD}$ (V)	BW (MHz)	SLEW RATE (V/ $\mu$ s)	$I_{DD}$ (per channel) ( $\mu$ A)	RAIL-TO-RAIL
TLV245X	2.7 – 6.0	0.22	0.11	23	I/O
TLV247X	2.7 – 6.0	2.8	1.5	600	I/O
TLV246X	2.7 – 6.0	6.4	1.6	550	I/O
TLV277X	2.5 – 6.0	5.1	10.5	1000	O

† All specifications measured at 5 V.



Please be aware that an important notice concerning availability, standard warranty, and use in critical applications of Texas Instruments semiconductor products and disclaimers thereto appears at the end of this data sheet.

All trademarks are the property of their respective owners.

PRODUCTION DATA information is current as of publication date. Products conform to specifications per the terms of Texas Instruments standard warranty. Production processing does not necessarily include testing of all parameters.



WWW.TI.COM  
POST OFFICE BOX 1443 • HOUSTON, TEXAS 77251-1443

Copyright © 1998–2005, Texas Instruments Incorporated

# TLV2450, TLV2451, TLV2452, TLV2453, TLV2454, TLV2455, TLV245xA FAMILY OF 23- $\mu$ A 220-kHz RAIL-TO-RAIL INPUT/OUTPUT OPERATIONAL AMPLIFIERS WITH SHUTDOWN

SLOS218F – DECEMBER 1998 – REVISED JANUARY 2005

## description (continued)

Three members of the family (TLV2450/3/5) offer a shutdown terminal for conserving battery life in portable applications. During shutdown, the outputs are placed in a high-impedance state and the amplifier consumes only 16 nA/channel. The family is fully specified at 3 V and 5 V across an expanded industrial temperature range ( $-40^{\circ}\text{C}$  to  $125^{\circ}\text{C}$ ). The singles and duals are available in the SOT23 and MSOP packages, while the quads are available in TSSOP. The TLV2450 offers an amplifier with shutdown functionality all in a 6-pin SOT23 package, making it perfect for high density circuits.

### TLV2450 and TLV2451 AVAILABLE OPTIONS

T <sub>A</sub>	PACKAGED DEVICES			
	SMALL OUTLINE (D) <sup>†</sup>	SOT-23		PLASTIC DIP (P)
		(DBV)	SYMBOL	
0°C to 70°C	TLV2450CD TLV2451CD	TLV2450CDBV TLV2451CDBV	VAQC VARC	TLV2450CP TLV2451CP
$-40^{\circ}\text{C}$ to $125^{\circ}\text{C}$	TLV2450ID TLV2451ID	TLV2450IDBV TLV2451IDBV	VAQI VARI	TLV2450IP TLV2451IP
	TLV2450AID TLV2451AID	— —	— —	TLV2450AIP TLV2451AIP

<sup>†</sup> This package is available taped and reeled. To order this packaging option, add an R suffix to the part number (e.g., TLV2450CDR).

### TLV2452 and TLV2453 AVAILABLE OPTIONS

T <sub>A</sub>	PACKAGED DEVICES						
	SMALL OUTLINE (D) <sup>†</sup>	MSOP				PLASTIC DIP (N)	PLASTIC DIP (P)
		(DGK) <sup>†</sup>	SYMBOL <sup>‡</sup>	(DGS) <sup>†</sup>	SYMBOL <sup>‡</sup>		
0°C to 70°C	TLV2452CD TLV2453CD	TLV2452CDGK —	xxTIABI —	— TLV2453CDGS	— xxTIABK	— TLV2453CN	TLV2452CP —
$-40^{\circ}\text{C}$ to $125^{\circ}\text{C}$	TLV2452ID TLV2453ID	TLV2452IDGK —	xxTIABJ —	— TLV2453IDGS	— xxTIABL	— TLV2453IN	TLV2452IP —
	TLV2452AID TLV2453AID	— —	— —	— —	— —	— TLV2453AIN	TLV2452AIP —

<sup>†</sup> This package is available taped and reeled. To order this packaging option, add an R suffix to the part number (e.g., TLV2452CDR).

<sup>‡</sup> xx represents the device date code.

### TLV2454 and TLV2455 AVAILABLE OPTIONS

T <sub>A</sub>	PACKAGED DEVICES		
	SMALL OUTLINE (D) <sup>†</sup>	PLASTIC DIP (N)	TSSOP (PW) <sup>†</sup>
0°C to 70°C	TLV2454CD TLV2455CD	TLV2454CN TLV2455CN	TLV2454CPW TLV2455CPW
$-40^{\circ}\text{C}$ to $125^{\circ}\text{C}$	TLV2454ID TLV2455ID	TLV2454IN TLV2455IN	TLV2454IPW TLV2455IPW
	TLV2454AID TLV2455AID	TLV2454AIN TLV2455AIN	TLV2454AIPW TLV2455AIPW

<sup>†</sup> This package is available taped and reeled. To order this packaging option, add an R suffix to the part number (e.g., TLV2454CDR).

**NOTE:** For the most current package and ordering information, see the Package Option Addendum located at the end of this data sheet, or refer to our web site at [www.ti.com](http://www.ti.com).



# TLV2450, TLV2451, TLV2452, TLV2453, TLV2454, TLV2455, TLV245xA FAMILY OF 23- $\mu$ A 220-kHz RAIL-TO-RAIL INPUT/OUTPUT OPERATIONAL AMPLIFIERS WITH SHUTDOWN

SLOS218F – DECEMBER 1998 – REVISED JANUARY 2005

## TLV245x PACKAGE PINOUTS(1)

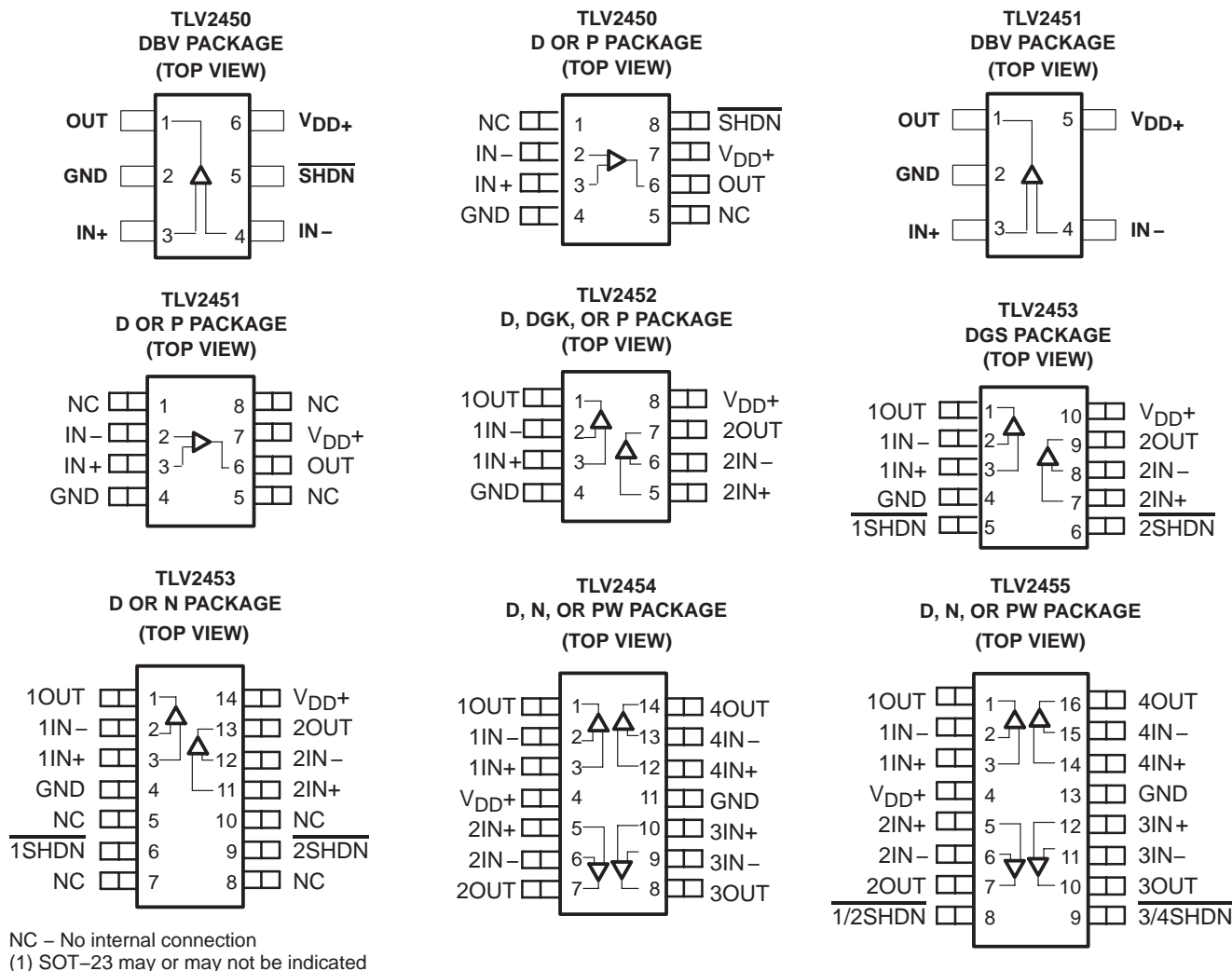

## TYPICAL PIN 1 INDICATORS

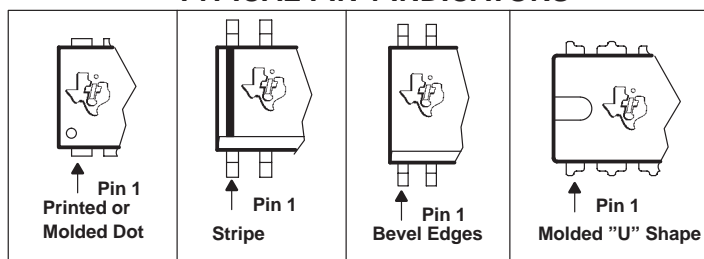

# TLV2450, TLV2451, TLV2452, TLV2453, TLV2454, TLV2455, TLV245xA

## FAMILY OF 23- $\mu$ A 220-kHz RAIL-TO-RAIL INPUT/OUTPUT OPERATIONAL AMPLIFIERS WITH SHUTDOWN

SLOS218F – DECEMBER 1998 – REVISED JANUARY 2005

### absolute maximum ratings over operating free-air temperature range (unless otherwise noted)<sup>†</sup>

Supply voltage, $V_{DD}$ (see Note 1)	7 V
Differential input voltage, $V_{ID}$	$\pm V_{DD}$
Continuous total power dissipation	See Dissipation Rating Table
Operating free-air temperature range, $T_A$ : C suffix	0°C to 70°C
I suffix	-40°C to 125°C
Maximum junction temperature, $T_J$	150°C
Storage temperature range, $T_{stg}$	-65°C to 150°C
Lead temperature 1,6 mm (1/16 inch) from case for 10 seconds	260°C

<sup>†</sup> Stresses beyond those listed under “absolute maximum ratings” may cause permanent damage to the device. These are stress ratings only, and functional operation of the device at these or any other conditions beyond those indicated under “recommended operating conditions” is not implied. Exposure to absolute-maximum-rated conditions for extended periods may affect device reliability.

**NOTE:** All voltage values, except differential voltages, are with respect to GND.

DISSIPATION RATING TABLE

PACKAGE	$\theta_{JC}$ (°C/W)	$\theta_{JA}$ (°C/W)	$T_A \leq 25^\circ\text{C}$ POWER RATING
D (8)	38.3	176	710 mW
D (14)	26.9	122.3	1022 mW
D (16)	25.7	114.7	1090 mW
DBV (5)	55	324.1	385 mW
DBV (6)	55	294.3	425 mW
DGK (8)	54.2	259.9	481 mW
DGS (10)	54.1	257.7	485 mW
N (14, 16)	32	78	1600 mW
P (8)	41	104	1200 mW
PW (14)	29.3	173.6	720 mW
PW (16)	28.7	161.4	774 mW

### recommended operating conditions

		MIN	MAX	UNIT
Supply voltage, $V_{DD}$	Single supply	2.7	6	V
	Split supply	$\pm 1.35$	$\pm 3$	
Common-mode input voltage range, $V_{ICR}$		0	$V_{DD}$	V
Operating free-air temperature, $T_A$	C-suffix	0	70	°C
	I-suffix	-40	125	
Shutdown on/off voltage level <sup>‡</sup>	$V_{IH}$	2		V
	$V_{IL}$	$V_{DD} = 5V$	0.8	
		$V_{DD} = 3V$	0.5	V

<sup>‡</sup> Relative to voltage on the GND terminal of the device.



**TLV2450, TLV2451, TLV2452, TLV2453, TLV2454, TLV2455, TLV245xA**  
**FAMILY OF 23- $\mu$ A 220-kHz RAIL-TO-RAIL INPUT/OUTPUT**  
**OPERATIONAL AMPLIFIERS WITH SHUTDOWN**

SLOS218F – DECEMBER 1998 – REVISED JANUARY 2005

**electrical characteristics at specified free-air temperature,  $V_{DD} = 3$  V (unless otherwise noted)**

PARAMETER		TEST CONDITIONS		$T_A$ †	MIN	TYP	MAX	UNIT
$V_{IO}$	Input offset voltage	TLV245x	$V_{DD} = \pm 1.5$ V $V_{IC} = 0$ , $V_O = 0$ , $R_S = 50$ $\Omega$	25°C	300	1500		$\mu$ V
				Full range		2000		
		TLV245xA		25°C	300	1000		
				Full range		1300		
$\alpha_{VIO}$	Temperature coefficient of input offset voltage					0.3		$\mu$ V/°C
$I_{IO}$	Input offset current			25°C		0.3	4.5	nA
				Full range			5.5	
$I_{IB}$	Input bias current			25°C		0.9	5	nA
				Full range			7	
$V_{OH}$	High-level output voltage	$V_{IC} = 1.5$ V,	$I_{OH} = -500$ $\mu$ A	25°C	2.85	2.95		V
				Full range	2.83			
$V_{OL}$	Low-level output voltage	$V_{IC} = 1.5$ V,	$I_{OL} = 500$ $\mu$ A	25°C		0.09	0.16	V
				Full range			0.2	
$I_{OS}$	Short-circuit output current	Sourcing		25°C	4	12		mA
				Full range	3			
		Sinking		25°C	2	7		
				Full range	1			
$I_O$	Output current	$V_O = 0.5$ V from rail		25°C		$\pm 4$		mA
$A_{VD}$	Large-signal differential voltage amplification	$V_{O(PP)} = 1$ V,	$R_L = 10$ k $\Omega$	25°C	96	110		dB
				Full range	91			
$r_{i(d)}$	Differential input resistance			25°C		$10^9$		$\Omega$
$C_{IC}$	Common-mode input capacitance	$f = 10$ kHz		25°C		4.5		pF
$z_o$	Closed-loop output impedance	$f = 10$ kHz,	$A_V = 10$	25°C		80		$\Omega$
CMRR	Common-mode rejection ratio	$V_{IC} = 0$ to 3 V, $R_S = 50$ $\Omega$	TLV245xC	25°C	70	80		dB
				Full range	66			
$k_{SVR}$	Supply voltage rejection ratio ( $\Delta V_{DD} / \Delta V_{IO}$ )	$V_{DD} = 2.7$ V to 6 V, No load	$V_{IC} = V_{DD}/2$ ,	25°C	76	89		dB
				Full range	74			
		$V_{DD} = 3$ V to 5 V, No load		25°C	88	106		
				Full range	84			
$I_{DD}$	Supply current (per channel)	$V_O = 1.5$ V, No load	TLV245xC	25°C		23	35	$\mu$ A
				Full range			40	
				TLV245xl	Full range			
$I_{DD(SHDN)}$	Supply current in shutdown mode (TLV2450, TLV2453, TLV2455) (per channel)	$\overline{SHDN} = -V_{DD}$	TLV245xC	25°C		12	65	nA
				Full range			70	
				TLV245xl	Full range			

† Full range is 0°C to 70°C for C suffix and –40°C to 125°C for l suffix.



**TLV2450, TLV2451, TLV2452, TLV2453, TLV2454, TLV2455, TLV245xA**  
**FAMILY OF 23- $\mu$ A 220-kHz RAIL-TO-RAIL INPUT/OUTPUT**  
**OPERATIONAL AMPLIFIERS WITH SHUTDOWN**

SLOS218F – DECEMBER 1998 – REVISED JANUARY 2005

operating characteristics at specified free-air temperature,  $V_{DD} = 3\text{ V}$  (unless otherwise noted)

PARAMETER		TEST CONDITIONS		$T_A$ †	MIN	TYP	MAX	UNIT
SR	Slew rate at unity gain	$V_{O(PP)} = 0.8\text{ V}$ , $R_L = 10\text{ k}\Omega$	$C_L = 150\text{ pF}$	25°C	0.05	0.11		V/ $\mu$ s
				Full range	0.02			
$V_n$	Equivalent input noise voltage	f = 100 Hz		25°C		49		nV/ $\sqrt{\text{Hz}}$
		f = 1 kHz		25°C		51		
$I_n$	Equivalent input noise current	f = 1 kHz		25°C		3.5		pA/ $\sqrt{\text{Hz}}$
THD + N	Total harmonic distortion plus noise	$V_{O(PP)} = 1.5\text{ V}$ , $R_L = 10\text{ k}\Omega$ , f = 1 kHz		25°C	$A_V = 1$			
					0.04%			
					$A_V = 10$			
			0.3%					
			$A_V = 100$			1.5%		
$t_{(on)}$	Amplifier turnon time	$A_V = 5$ , $R_L = \text{OPEN}$ ,		25°C		59		$\mu$ s
$t_{(off)}$	Amplifier turnoff time	Measured at 50% point		25°C		836		ns
Gain-bandwidth product		f = 10 kHz,	$R_L = 10\text{ k}\Omega$	25°C		200		kHz
$t_s$	Settling time	$V_{(STEP)PP} = 2\text{ V}$ , $A_V = -1$ , $C_L = 10\text{ pF}$ , $R_L = 10\text{ k}\Omega$	0.1%	25°C	26			$\mu$ s
			0.01%		31			
		$V_{(STEP)PP} = 2\text{ V}$ , $A_V = -1$ , $C_L = 56\text{ pF}$ , $R_L = 10\text{ k}\Omega$	0.1%		26			
			0.01%		31			
$\phi_m$	Phase margin	$R_L = 10\text{ k}\Omega$ ,	$C_L = 1000\text{ pF}$	25°C		56°		
Gain margin		$R_L = 10\text{ k}\Omega$ ,	$C_L = 1000\text{ pF}$	25°C		7		dB

† Full range is 0°C to 70°C for C suffix and -40°C to 125°C for I suffix.



**TLV2450, TLV2451, TLV2452, TLV2453, TLV2454, TLV2455, TLV245xA**  
**FAMILY OF 23- $\mu$ A 220-kHz RAIL-TO-RAIL INPUT/OUTPUT**  
**OPERATIONAL AMPLIFIERS WITH SHUTDOWN**

SLOS218F – DECEMBER 1998 – REVISED JANUARY 2005

**electrical characteristics at specified free-air temperature,  $V_{DD} = 5$  V (unless otherwise noted)**

PARAMETER		TEST CONDITIONS		$T_A$ †	MIN	TYP	MAX	UNIT	
$V_{IO}$	Input offset voltage			25°C		300	1500	$\mu$ V	
				Full range			2000		
				25°C		300	1000		
				Full range			1300		
$\alpha_{VIO}$	Temperature coefficient of input offset voltage		$V_{DD} = \pm 2.5$ V $V_{IC} = 0$ , $V_O = 0$ , $R_S = 50$ $\Omega$			0.3		$\mu$ V/°C	
$I_{IO}$	Input offset current			25°C		0.3	4.5	nA	
				Full range			5.5		
$I_{IB}$	Input bias current			25°C		0.5	5	nA	
				Full range			7		
$V_{OH}$	High-level output voltage		$V_{IC} = 2.5$ V, $I_{OH} = -500$ $\mu$ A	25°C	4.87	4.97		V	
				Full range	4.85				
$V_{OL}$	Low-level output voltage		$V_{IC} = 2.5$ V, $I_{OL} = 500$ $\mu$ A	25°C		0.07	0.15	V	
				Full range			0.16		
$I_{OS}$	Short-circuit output current			Sourcing		25°C	20	32	mA
				Full range		18			
				Sinking		25°C	12	18	
				Full range		10			
$I_O$	Output current		$V_O = 0.5$ V from rail	25°C		$\pm 10$		mA	
$A_{VD}$	Large-signal differential voltage amplification		$V_{O(PP)} = 3$ V, $R_L = 10$ k $\Omega$	25°C	96	103		dB	
				Full range	91				
$r_{i(d)}$	Differential input resistance			25°C		$10^9$		$\Omega$	
$C_{IC}$	Common-mode input capacitance		$f = 10$ kHz	25°C		4.5		pF	
$z_o$	Closed-loop output impedance		$f = 10$ kHz, $A_V = 10$	25°C		45		$\Omega$	
CMRR	Common-mode rejection ratio		$V_{IC} = 0$ to 5 V, $R_S = 50$ $\Omega$	25°C	70	80		dB	
				Full range	68				
$k_{SVR}$	Supply voltage rejection ratio ( $\Delta V_{DD} / \Delta V_{IO}$ )		$V_{DD} = 2.7$ V to 6 V, No load $V_{IC} = V_{DD}/2$	25°C	76	89		dB	
				Full range	74				
				25°C	88	106			
				Full range	84				
$I_{DD}$	Supply current (per channel)		$V_O = 2.5$ V, No load	25°C		23	42	$\mu$ A	
				Full range			44		
				Full range			46		
$I_{DD(SHDN)}$	Supply current in shutdown mode (TLV2450, TLV2453, TLV2455) (per channel)		$\overline{SHDN} = -V_{DD}$	25°C		16	70	nA	
				Full range			70		
				Full range			80		

† Full range is 0°C to 70°C for C suffix and -40°C to 125°C for I suffix.



**TLV2450, TLV2451, TLV2452, TLV2453, TLV2454, TLV2455, TLV245xA**  
**FAMILY OF 23- $\mu$ A 220-kHz RAIL-TO-RAIL INPUT/OUTPUT**  
**OPERATIONAL AMPLIFIERS WITH SHUTDOWN**

SLOS218F – DECEMBER 1998 – REVISED JANUARY 2005

operating characteristics at specified free-air temperature,  $V_{DD} = 5\text{ V}$  (unless otherwise noted)

PARAMETER		TEST CONDITIONS		$T_A$ †	MIN	TYP	MAX	UNIT
SR	Slew rate at unity gain	$V_{O(PP)} = 2\text{ V}$ , $R_L = 10\text{ k}\Omega$	$C_L = 150\text{ pF}$	25°C	0.05	0.11		V/ $\mu$ s
				Full range	0.02			
$V_n$	Equivalent input noise voltage	f = 100 Hz		25°C		49		nV/ $\sqrt{\text{Hz}}$
		f = 1 kHz		25°C		52		
$I_n$	Equivalent input noise current	f = 1 kHz		25°C		3.5		pA/ $\sqrt{\text{Hz}}$
THD + N	Total harmonic distortion plus noise	$V_{O(PP)} = 3\text{ V}$ , $R_L = 10\text{ k}\Omega$ , f = 1 kHz		25°C	$A_V = 1$			
					$A_V = 10$			
					$A_V = 100$			
$t_{(on)}$	Amplifier turnon time	$A_V = 5$ , $R_L = \text{OPEN}$ ,		25°C		59		$\mu$ s
$t_{(off)}$	Amplifier turnoff time	Measured at 50% point		25°C		836		ns
	Gain-bandwidth product	f = 10 kHz,	$R_L = 10\text{ k}\Omega$	25°C		220		kHz
$t_s$	Settling time	$V_{(STEP)PP} = 2\text{ V}$ , $A_V = -1$ , $C_L = 10\text{ pF}$ , $R_L = 10\text{ k}\Omega$	0.1%	25°C	24			$\mu$ s
			0.01%		30			
		$V_{(STEP)PP} = 2\text{ V}$ , $A_V = -1$ , $C_L = 56\text{ pF}$ , $R_L = 10\text{ k}\Omega$	0.1%		25			
			0.01%		30			
$\phi_m$	Phase margin	$R_L = 10\text{ k}\Omega$ ,	$C_L = 1000\text{ pF}$	25°C		56°		
	Gain margin	$R_L = 10\text{ k}\Omega$ ,	$C_L = 1000\text{ pF}$	25°C		7		dB

† Full range is 0°C to 70°C for C suffix and -40°C to 125°C for I suffix.





**TLV2450, TLV2451, TLV2452, TLV2453, TLV2454, TLV2455, TLV245xA**  
**FAMILY OF 23- $\mu$ A 220-kHz RAIL-TO-RAIL INPUT/OUTPUT**  
**OPERATIONAL AMPLIFIERS WITH SHUTDOWN**

SLOS218F – DECEMBER 1998 – REVISED JANUARY 2005

**TYPICAL CHARACTERISTICS**

**Table of Graphs**

			FIGURE
$V_{IO}$	Input offset voltage	vs Common-mode input voltage	1, 2
$I_{IO}$	Input offset current	vs Common-mode input voltage vs Free-air temperature	3, 4 7, 8
$I_{IB}$	Input bias current	vs Common-mode input voltage vs Free-air temperature	5, 6 7, 8
$A_{VD}$	Differential voltage amplification	vs Frequency	9, 10
	Phase	vs Frequency	9, 10
$V_{OL}$	Low-level output voltage	vs Low-level output current	11, 13
$V_{OH}$	High-level output voltage	vs High-level output current	12, 14
$Z_o$	Output impedance	vs Frequency	15, 16
CMRR	Common-mode rejection ratio	vs Frequency	17
PSRR	Power supply rejection ratio	vs Frequency	18
$I_{DD}$	Supply current	vs Supply voltage	19
$I_{DD}$	Supply current	vs Free-air temperature	20
$V_n$	Equivalent input noise voltage	vs Frequency	21
THD + N	Total harmonic distortion plus noise	vs Frequency	22, 23
$\phi_m$	Phase margin	vs Load capacitance	24
	Gain-bandwidth product	vs Supply voltage	25
SR	Slew rate	vs Supply voltage vs Free-air temperature	26 27
$V_{O(PP)}$	Maximum peak-to-peak output voltage	vs Frequency	28
	Crosstalk	vs Frequency	29, 30
	Small-signal follower pulse response	vs Time	31, 33
	Large-signal follower pulse response	vs Time	32, 34
	Shutdown on supply current	vs Time	35
	Shutdown off supply current	vs Time	36
	Shutdown supply current	vs Free-air temperature	37
	Shutdown supply current	vs Time	38 – 41
	Shutdown pulse	vs Time	38 – 41
	Shutdown off pulse response	vs Time	42, 43
	Shutdown on pulse response	vs Time	44, 45
	Shutdown reverse isolation	vs Frequency	46
	Shutdown forward isolation	vs Frequency	47



**TLV2450, TLV2451, TLV2452, TLV2453, TLV2454, TLV2455, TLV245xA**  
**FAMILY OF 23- $\mu$ A 220-kHz RAIL-TO-RAIL INPUT/OUTPUT**  
**OPERATIONAL AMPLIFIERS WITH SHUTDOWN**

SLOS218F – DECEMBER 1998 – REVISED JANUARY 2005

**TYPICAL CHARACTERISTICS**

**INPUT OFFSET VOLTAGE**  
**vs**  
**COMMON-MODE INPUT VOLTAGE**

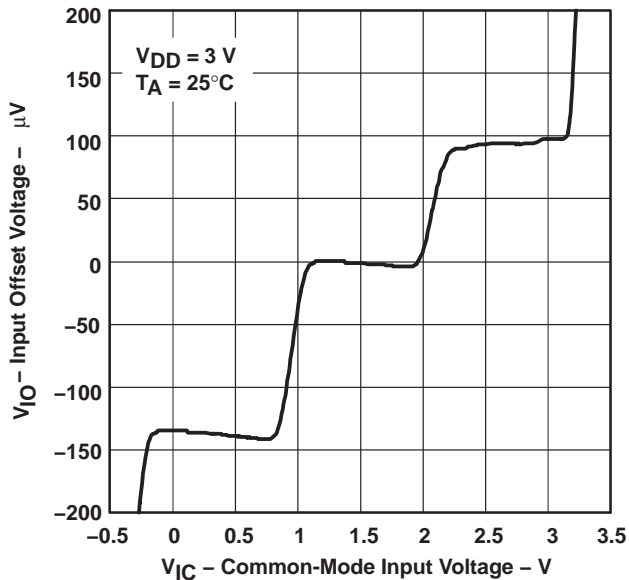

**Figure 1**

**INPUT OFFSET VOLTAGE**  
**vs**  
**COMMON-MODE INPUT VOLTAGE**

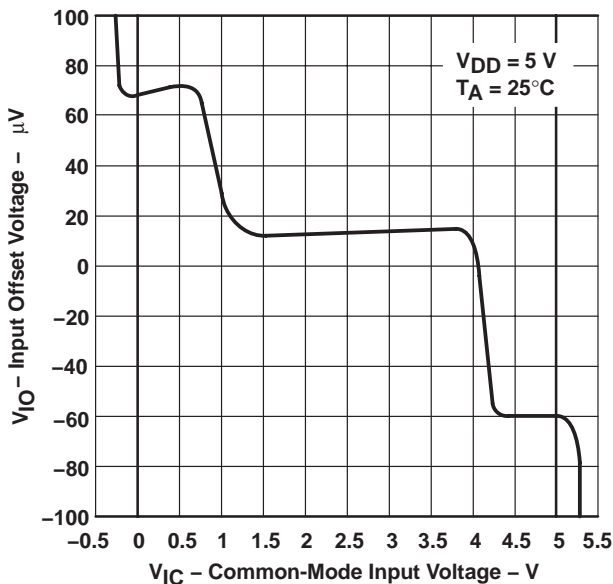

**Figure 2**

**INPUT OFFSET CURRENT**  
**vs**  
**COMMON-MODE INPUT VOLTAGE**

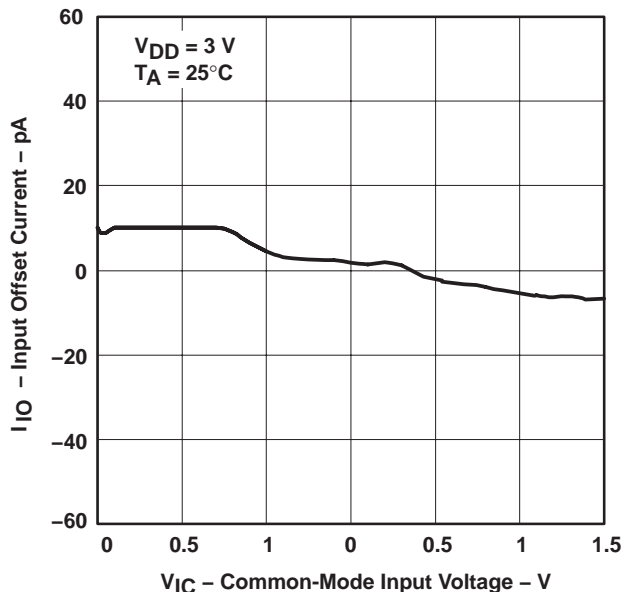

**Figure 3**

**INPUT OFFSET CURRENT**  
**vs**  
**COMMON-MODE INPUT VOLTAGE**

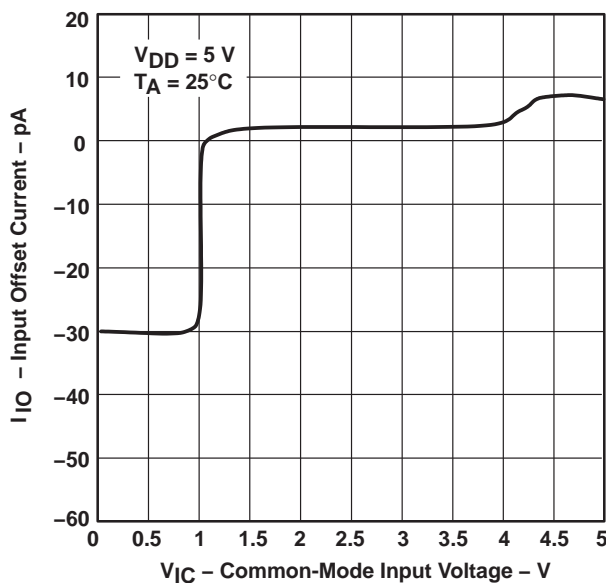

**Figure 4**

TLV2450, TLV2451, TLV2452, TLV2453, TLV2454, TLV2455, TLV245xA  
 FAMILY OF 23- $\mu$ A 220-KHz RAIL-TO-RAIL INPUT/OUTPUT  
 OPERATIONAL AMPLIFIERS WITH SHUTDOWN

SLOS218F – DECEMBER 1998 – REVISED JANUARY 2005

TYPICAL CHARACTERISTICS

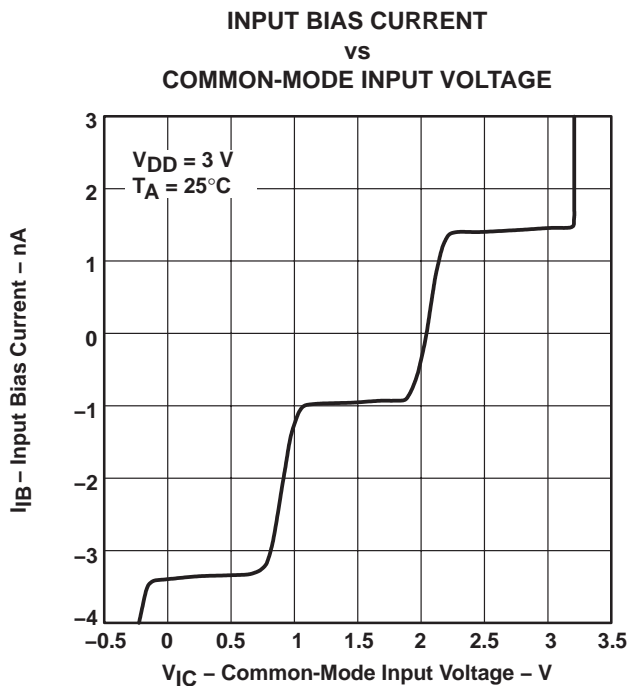

Figure 5

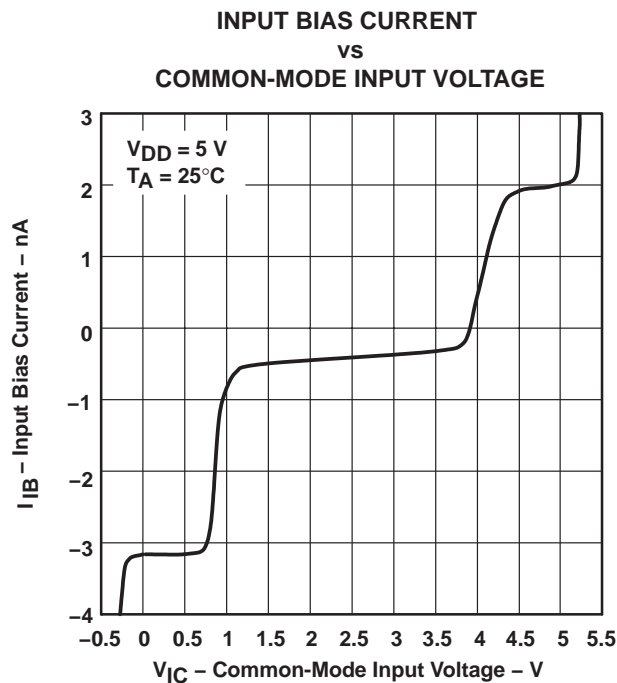

Figure 6

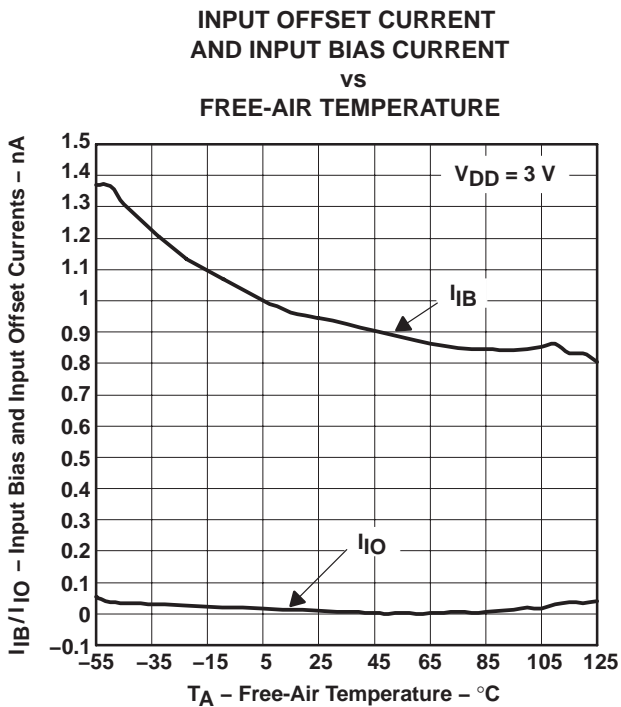

Figure 7

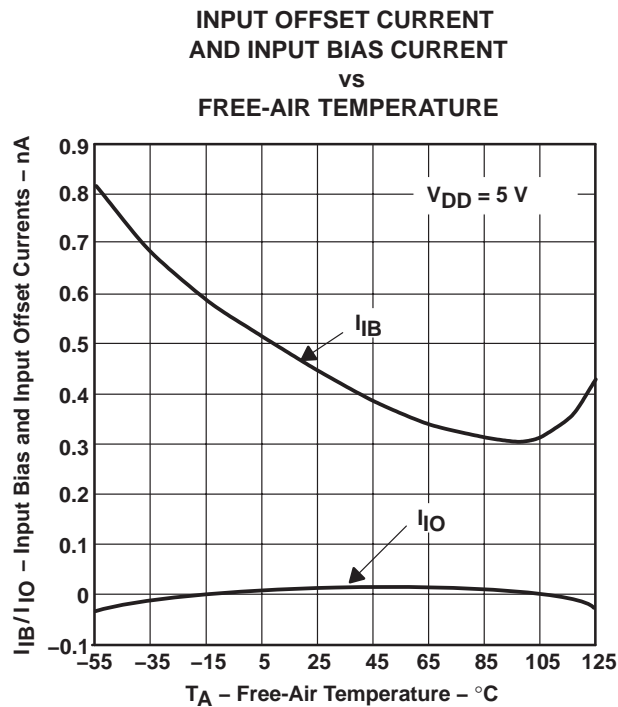

Figure 8

**TLV2450, TLV2451, TLV2452, TLV2453, TLV2454, TLV2455, TLV245xA**  
**FAMILY OF 23- $\mu$ A 220-kHz RAIL-TO-RAIL INPUT/OUTPUT**  
**OPERATIONAL AMPLIFIERS WITH SHUTDOWN**

SLOS218F – DECEMBER 1998 – REVISED JANUARY 2005

**TYPICAL CHARACTERISTICS**

**DIFFERENTIAL VOLTAGE AMPLIFICATION AND PHASE**  
**vs**  
**FREQUENCY**

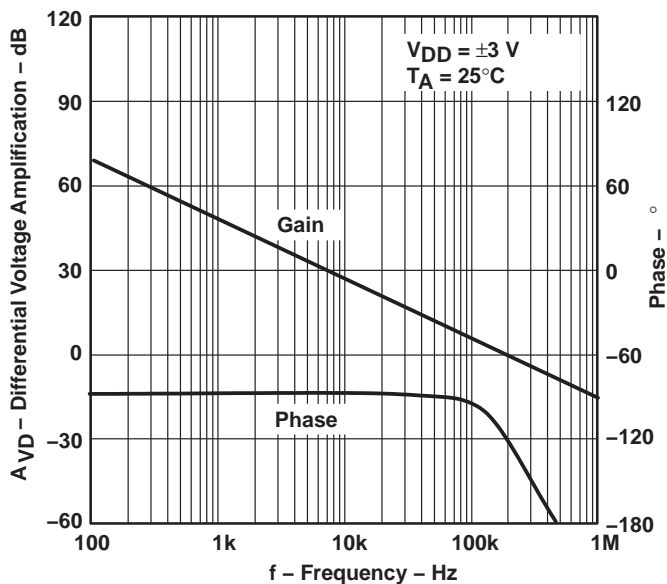

**Figure 9**

**DIFFERENTIAL VOLTAGE AMPLIFICATION AND PHASE**  
**vs**  
**FREQUENCY**

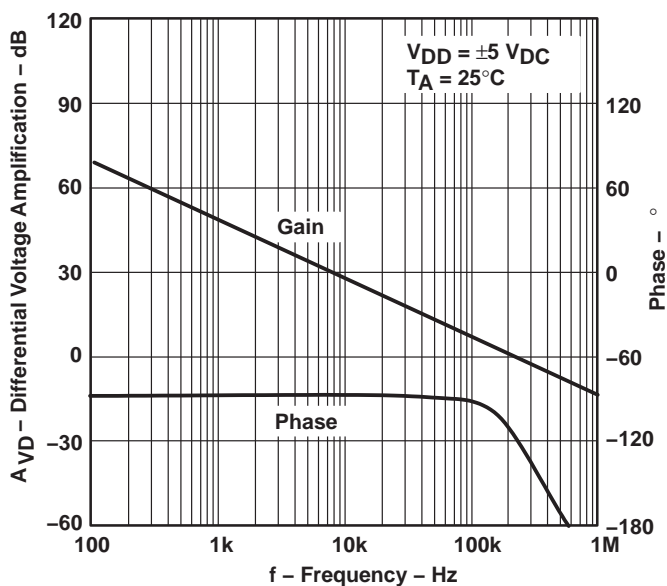

**Figure 10**



**TLV2450, TLV2451, TLV2452, TLV2453, TLV2454, TLV2455, TLV245xA**  
**FAMILY OF 23- $\mu$ A 220-KHz RAIL-TO-RAIL INPUT/OUTPUT**  
**OPERATIONAL AMPLIFIERS WITH SHUTDOWN**

SLOS218F – DECEMBER 1998 – REVISED JANUARY 2005

**TYPICAL CHARACTERISTICS**

**LOW-LEVEL OUTPUT VOLTAGE  
vs  
LOW-LEVEL OUTPUT CURRENT**

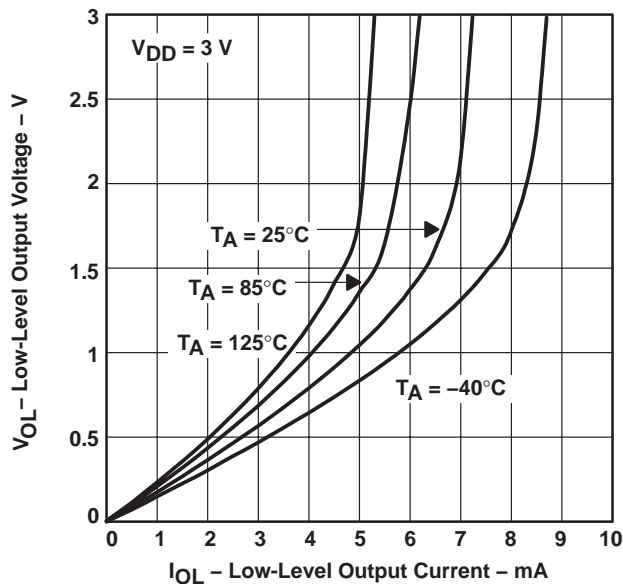

**Figure 11**

**HIGH-LEVEL OUTPUT VOLTAGE  
vs  
HIGH-LEVEL OUTPUT CURRENT**

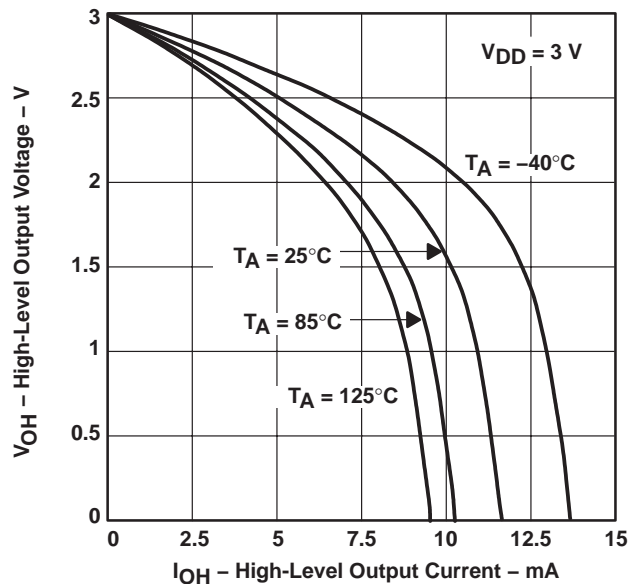

**Figure 12**

**LOW-LEVEL OUTPUT VOLTAGE  
vs  
LOW-LEVEL OUTPUT CURRENT**

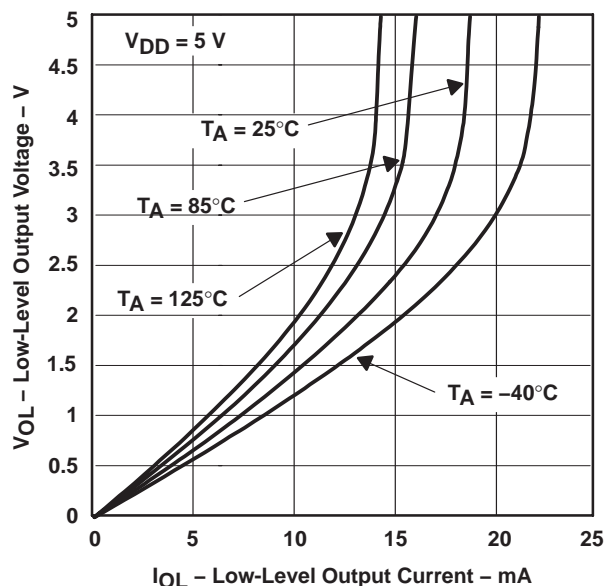

**Figure 13**

**HIGH-LEVEL OUTPUT VOLTAGE  
vs  
HIGH-LEVEL OUTPUT CURRENT**

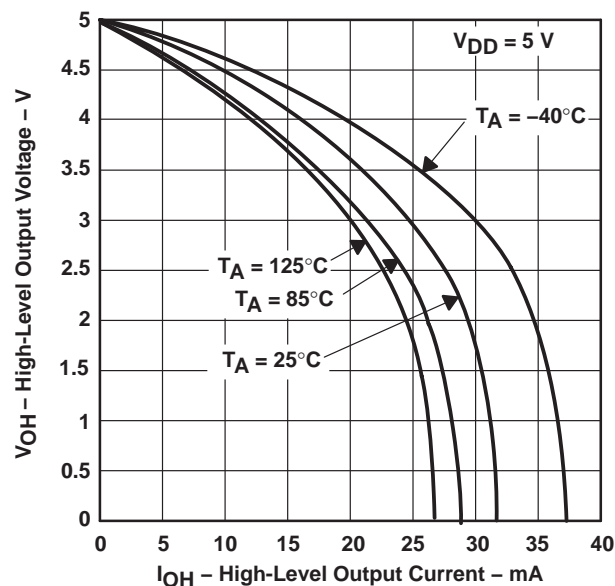

**Figure 14**

**TLV2450, TLV2451, TLV2452, TLV2453, TLV2454, TLV2455, TLV245xA**  
**FAMILY OF 23- $\mu$ A 220-kHz RAIL-TO-RAIL INPUT/OUTPUT**  
**OPERATIONAL AMPLIFIERS WITH SHUTDOWN**

SLOS218F – DECEMBER 1998 – REVISED JANUARY 2005

**TYPICAL CHARACTERISTICS**

**OUTPUT IMPEDANCE  
VS  
FREQUENCY**

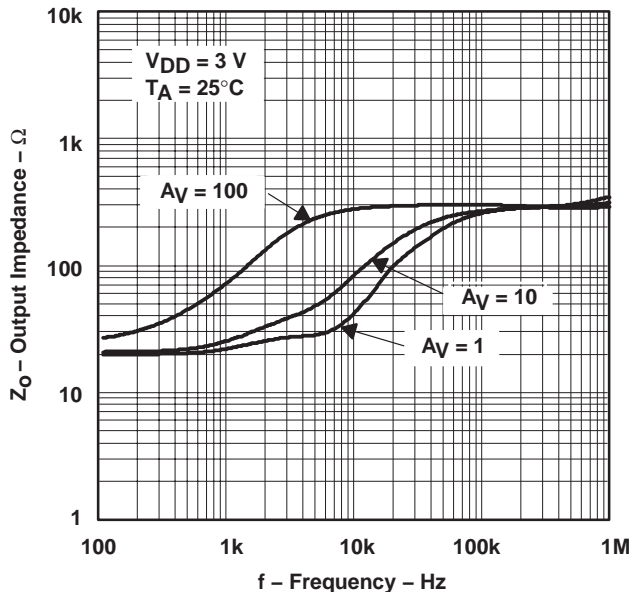

**Figure 15**

**OUTPUT IMPEDANCE  
VS  
FREQUENCY**

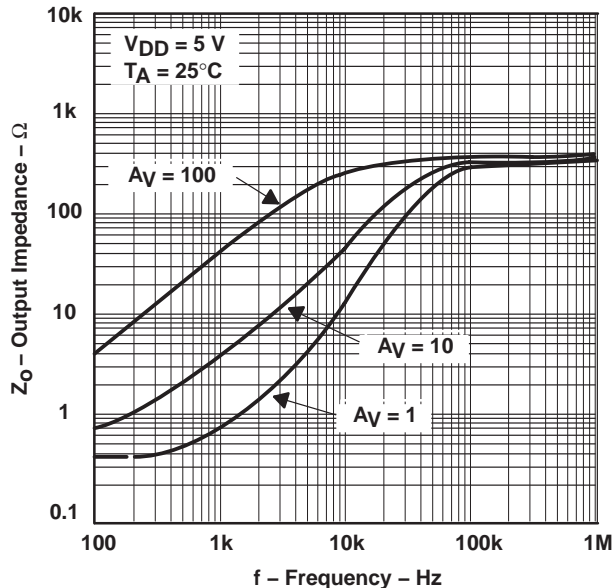

**Figure 16**

**COMMON-MODE REJECTION RATIO  
VS  
FREQUENCY**

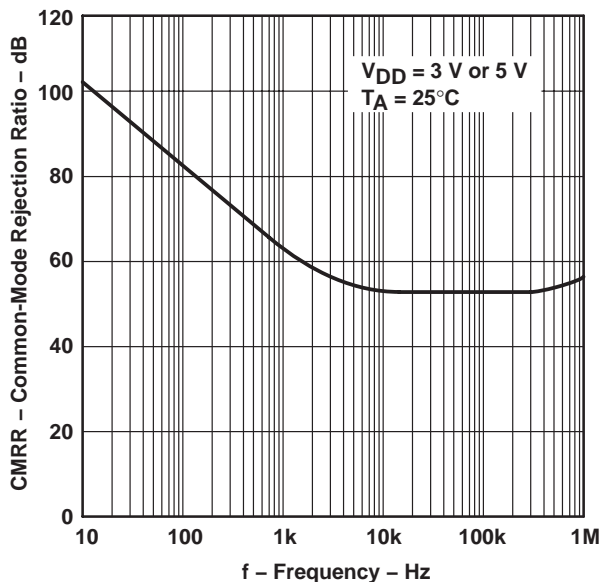

**Figure 17**



TLV2450, TLV2451, TLV2452, TLV2453, TLV2454, TLV2455, TLV245xA  
 FAMILY OF 23- $\mu$ A 220-kHz RAIL-TO-RAIL INPUT/OUTPUT  
 OPERATIONAL AMPLIFIERS WITH SHUTDOWN

SLOS218F – DECEMBER 1998 – REVISED JANUARY 2005

TYPICAL CHARACTERISTICS

POWER SUPPLY REJECTION RATIO  
 vs  
 FREQUENCY

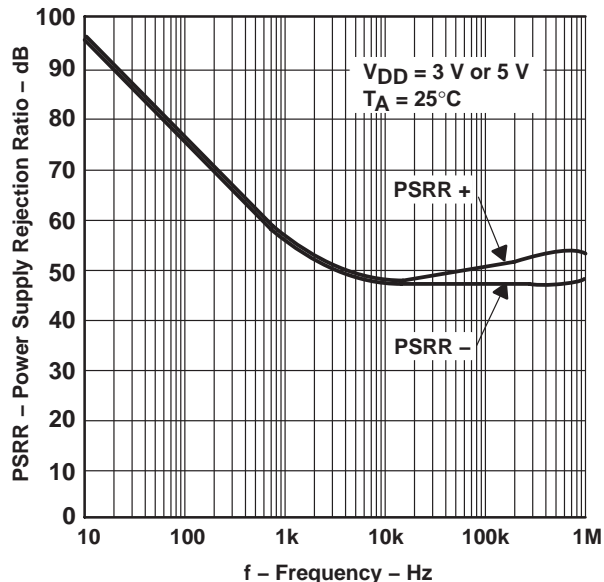

Figure 18

SUPPLY CURRENT  
 vs  
 SUPPLY VOLTAGE

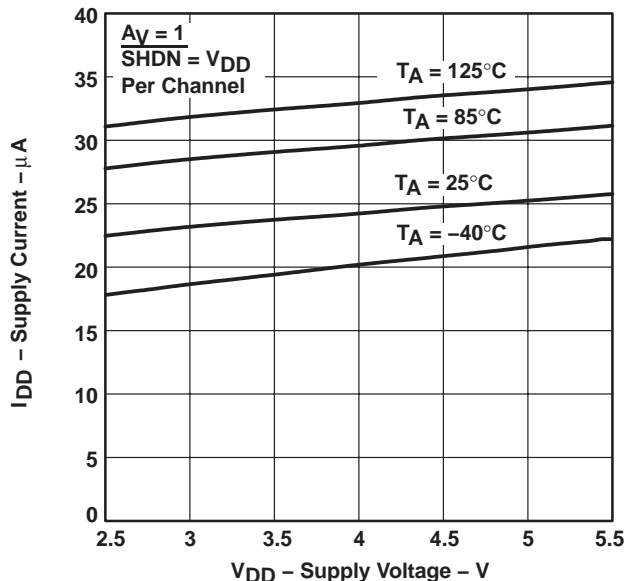

Figure 19

SUPPLY CURRENT  
 vs  
 FREE-AIR TEMPERATURE

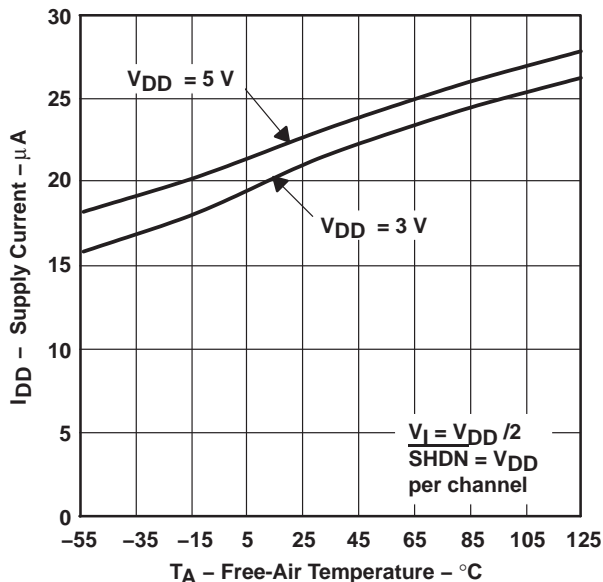

Figure 20

EQUIVALENT INPUT NOISE VOLTAGE  
 vs  
 FREQUENCY

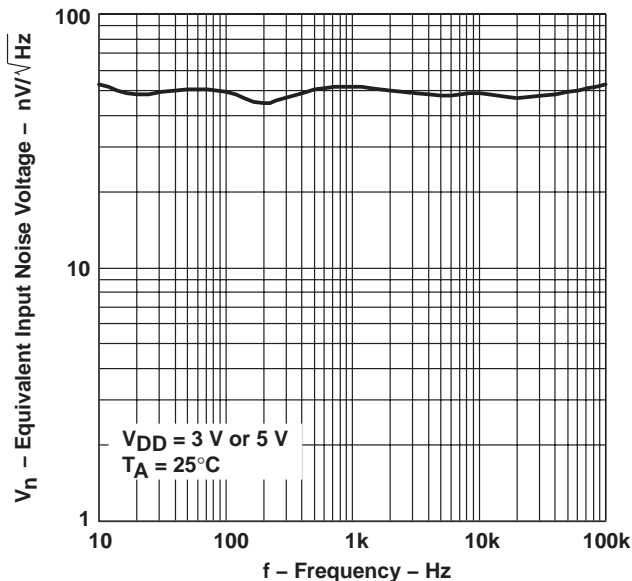

Figure 21



# TLV2450, TLV2451, TLV2452, TLV2453, TLV2454, TLV2455, TLV245xA

## FAMILY OF 23- $\mu$ A 220-kHz RAIL-TO-RAIL INPUT/OUTPUT OPERATIONAL AMPLIFIERS WITH SHUTDOWN

SLOS218F – DECEMBER 1998 – REVISED JANUARY 2005

### TYPICAL CHARACTERISTICS

**TOTAL HARMONIC DISTORTION PLUS NOISE**  
vs  
**FREQUENCY**

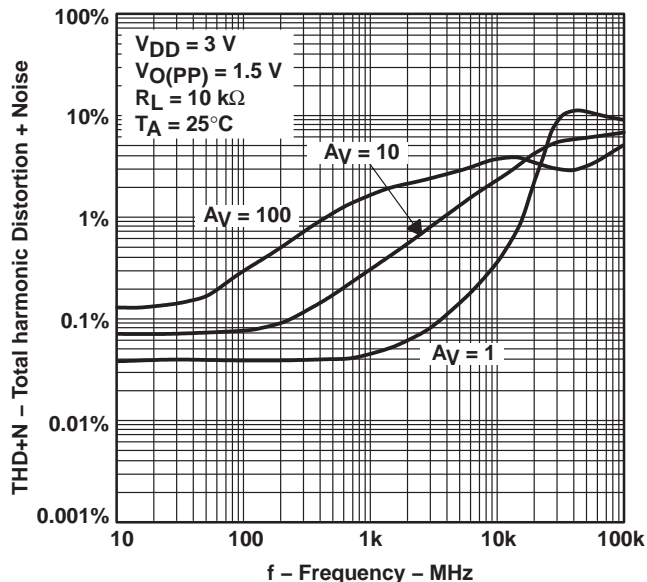

Figure 22

**TOTAL HARMONIC DISTORTION PLUS NOISE**  
vs  
**FREQUENCY**

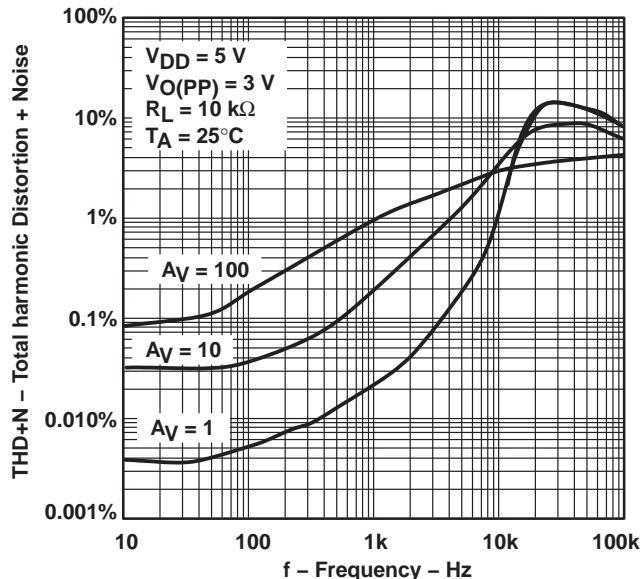

Figure 23

**PHASE MARGIN**  
vs  
**LOAD CAPACITANCE**

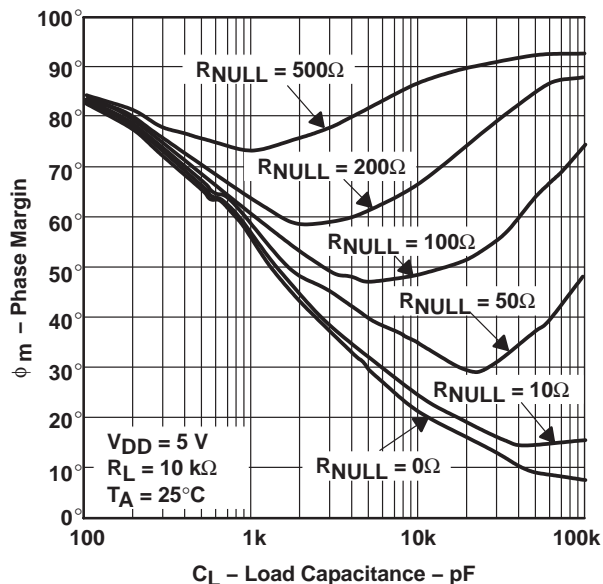

Figure 24

**GAIN-BANDWIDTH PRODUCT**  
vs  
**SUPPLY VOLTAGE**

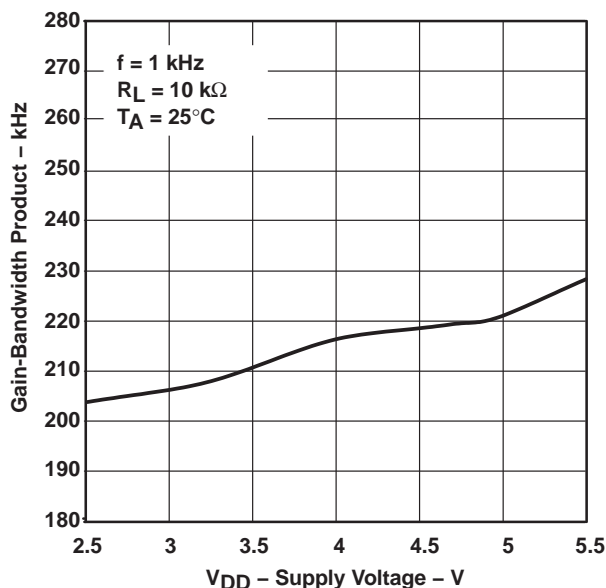

Figure 25





TLV2450, TLV2451, TLV2452, TLV2453, TLV2454, TLV2455, TLV245xA  
 FAMILY OF 23- $\mu$ A 220-kHz RAIL-TO-RAIL INPUT/OUTPUT  
 OPERATIONAL AMPLIFIERS WITH SHUTDOWN

SLOS218F – DECEMBER 1998 – REVISED JANUARY 2005

TYPICAL CHARACTERISTICS

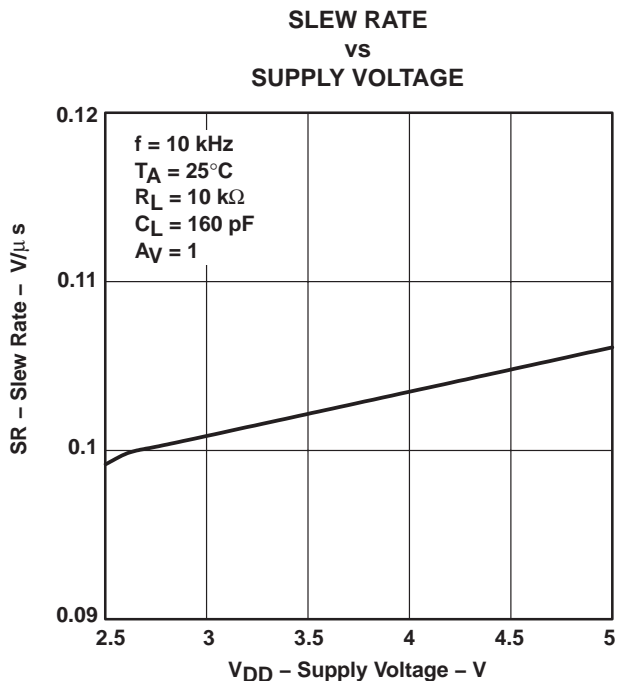

Figure 26

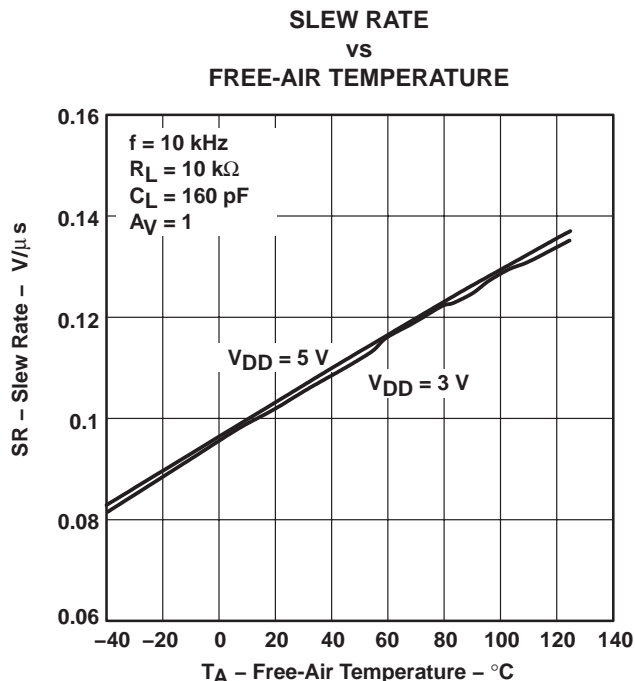

Figure 27

**MAXIMUM PEAK-TO-PEAK OUTPUT VOLTAGE  
vs  
FREQUENCY**

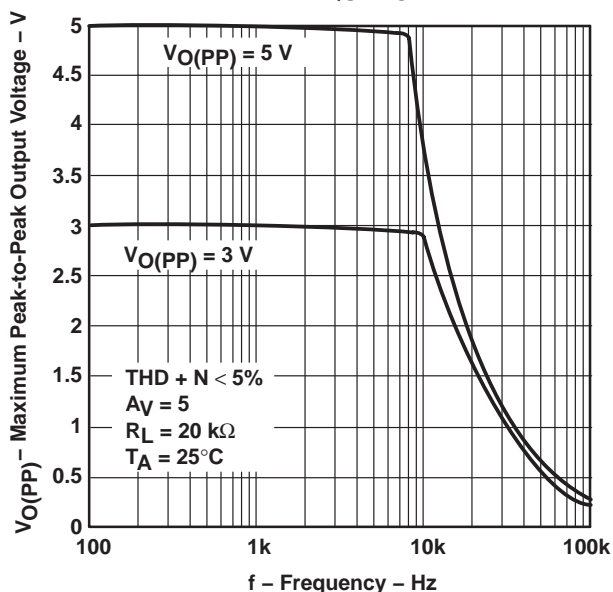

Figure 28

**TLV2450, TLV2451, TLV2452, TLV2453, TLV2454, TLV2455, TLV245xA**  
**FAMILY OF 23- $\mu$ A 220-kHz RAIL-TO-RAIL INPUT/OUTPUT**  
**OPERATIONAL AMPLIFIERS WITH SHUTDOWN**

SLOS218F – DECEMBER 1998 – REVISED JANUARY 2005

**TYPICAL CHARACTERISTICS**

**CROSTALK**  
**vs**  
**FREQUENCY**

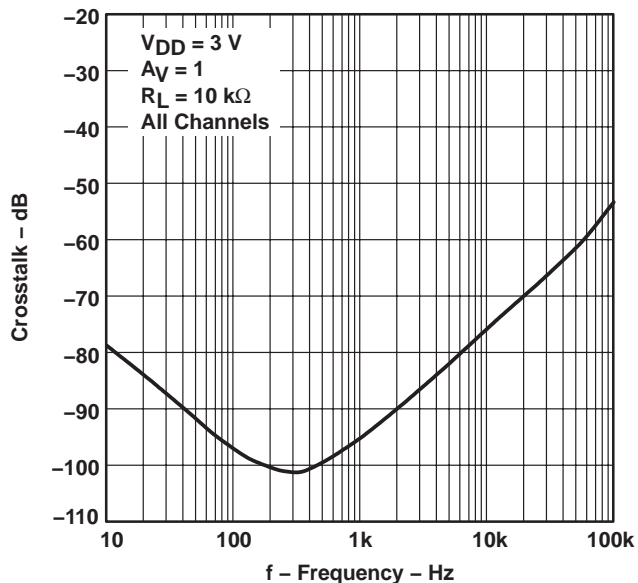

**Figure 29**

**CROSTALK**  
**vs**  
**FREQUENCY**

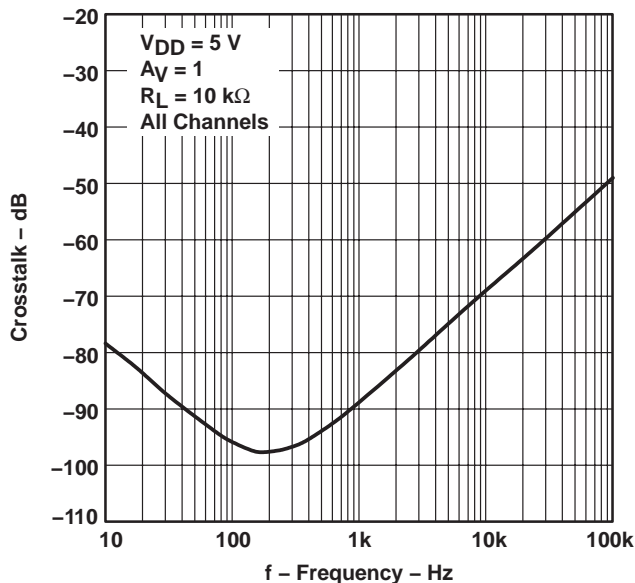

**Figure 30**

**SMALL-SIGNAL FOLLOWER PULSE RESPONSE**  
**vs**  
**TIME**

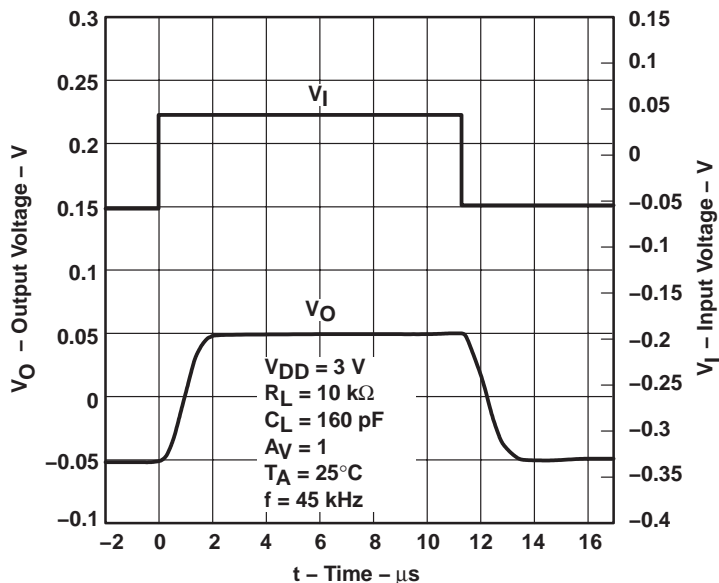

**Figure 31**



TLV2450, TLV2451, TLV2452, TLV2453, TLV2454, TLV2455, TLV245xA  
 FAMILY OF 23- $\mu$ A 220-kHz RAIL-TO-RAIL INPUT/OUTPUT  
 OPERATIONAL AMPLIFIERS WITH SHUTDOWN

SLOS218F – DECEMBER 1998 – REVISED JANUARY 2005

TYPICAL CHARACTERISTICS

LARGE-SIGNAL FOLLOWER PULSE RESPONSE  
 vs  
 TIME

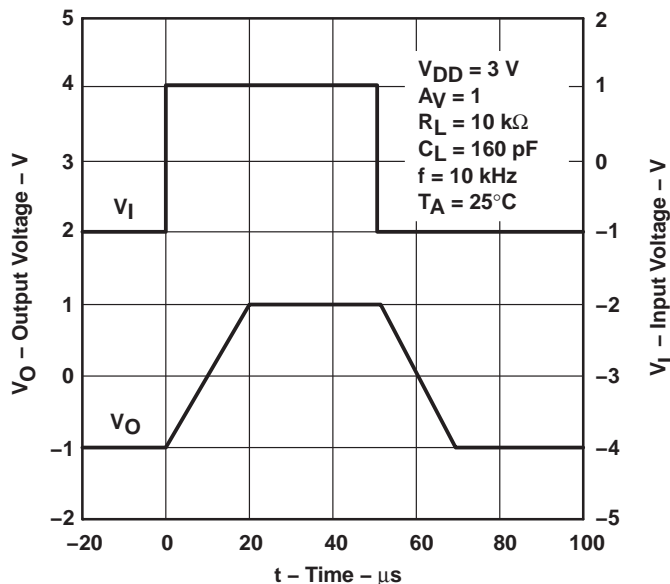

Figure 32

SMALL-SIGNAL FOLLOWER PULSE RESPONSE  
 vs  
 TIME

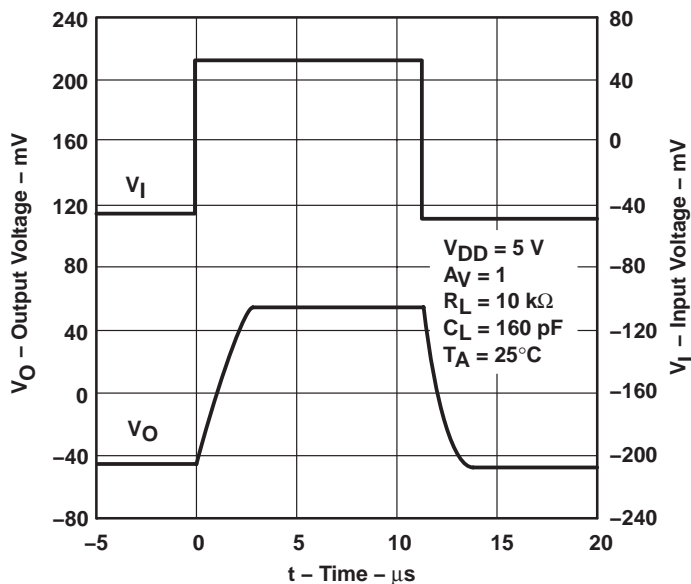

Figure 33



**TLV2450, TLV2451, TLV2452, TLV2453, TLV2454, TLV2455, TLV245xA**  
**FAMILY OF 23- $\mu$ A 220-kHz RAIL-TO-RAIL INPUT/OUTPUT**  
**OPERATIONAL AMPLIFIERS WITH SHUTDOWN**

SLOS218F – DECEMBER 1998 – REVISED JANUARY 2005

**TYPICAL CHARACTERISTICS**

**LARGE-SIGNAL FOLLOWER PULSE RESPONSE**  
**vs**  
**TIME**

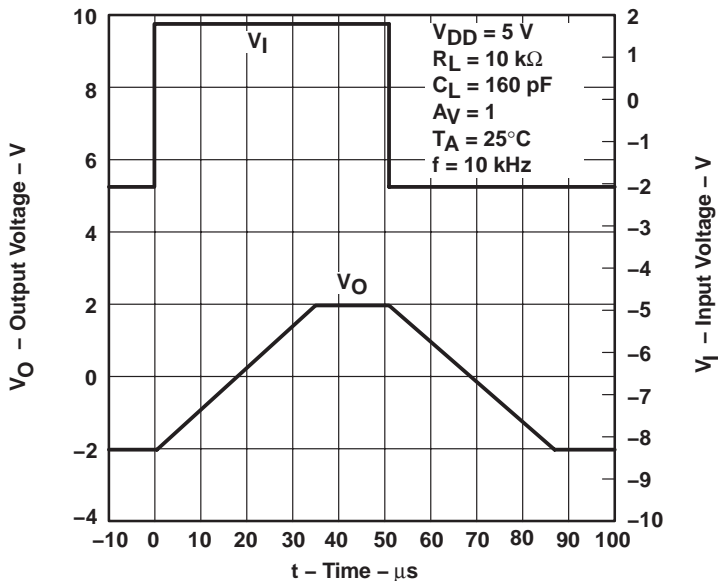

**Figure 34**

**SHUTDOWN ON SUPPLY CURRENT**  
**vs**  
**TIME**

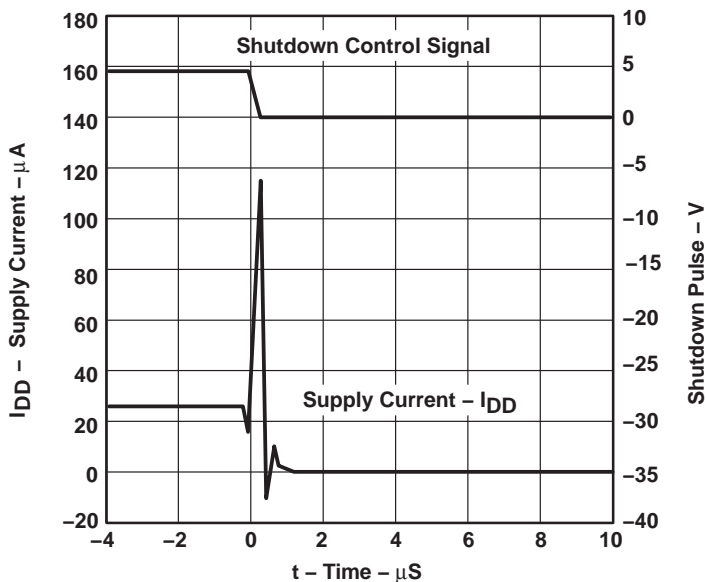

**Figure 35**



TLV2450, TLV2451, TLV2452, TLV2453, TLV2454, TLV2455, TLV245xA  
 FAMILY OF 23- $\mu$ A 220-kHz RAIL-TO-RAIL INPUT/OUTPUT  
 OPERATIONAL AMPLIFIERS WITH SHUTDOWN

SLOS218F – DECEMBER 1998 – REVISED JANUARY 2005

TYPICAL CHARACTERISTICS

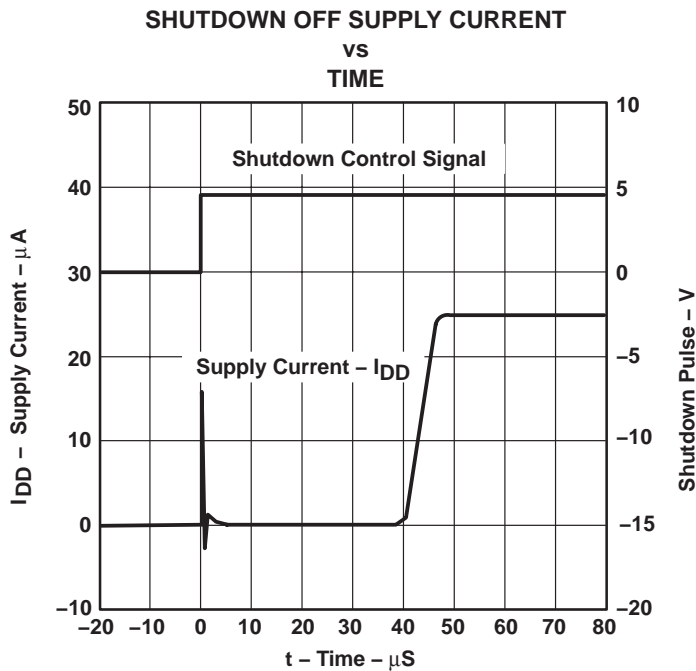

Figure 36

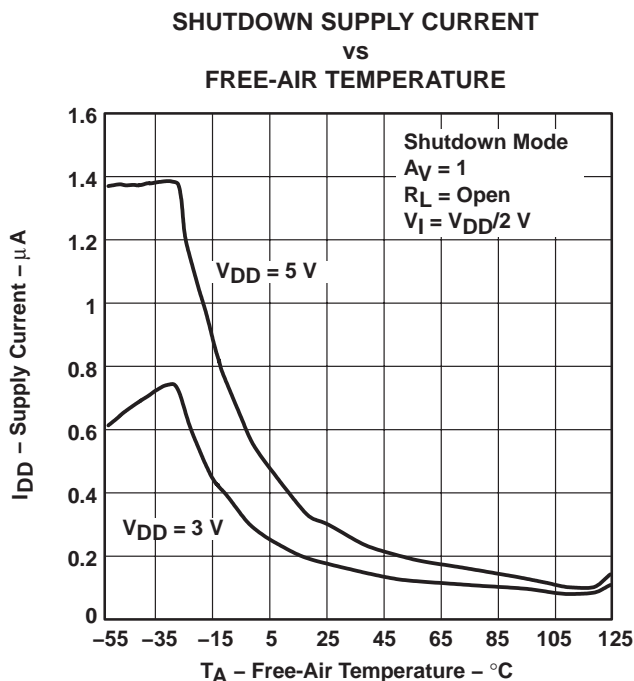

Figure 37

**TLV2450, TLV2451, TLV2452, TLV2453, TLV2454, TLV2455, TLV245xA**  
**FAMILY OF 23- $\mu$ A 220-kHz RAIL-TO-RAIL INPUT/OUTPUT**  
**OPERATIONAL AMPLIFIERS WITH SHUTDOWN**

SLOS218F – DECEMBER 1998 – REVISED JANUARY 2005

**TYPICAL CHARACTERISTICS**

**SHUTDOWN SUPPLY CURRENT AND SHUTDOWN PULSE**  
**vs**  
**TIME**

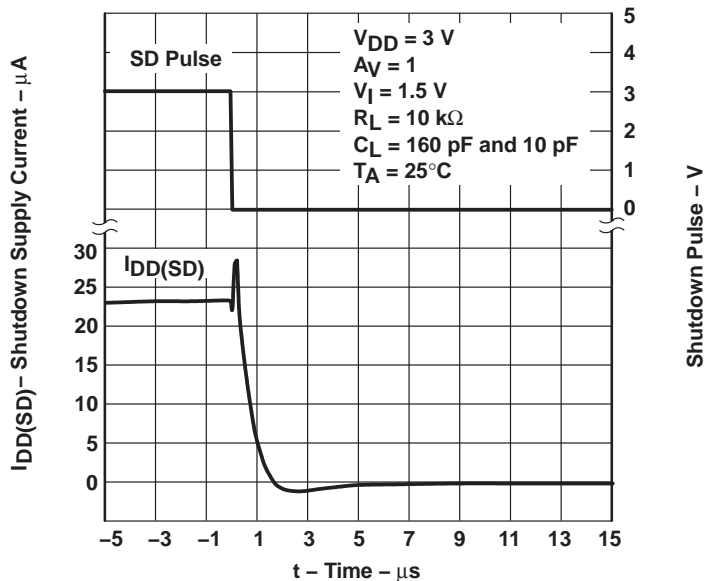

**Figure 38**

**SHUTDOWN SUPPLY CURRENT AND SHUTDOWN PULSE**  
**vs**  
**TIME**

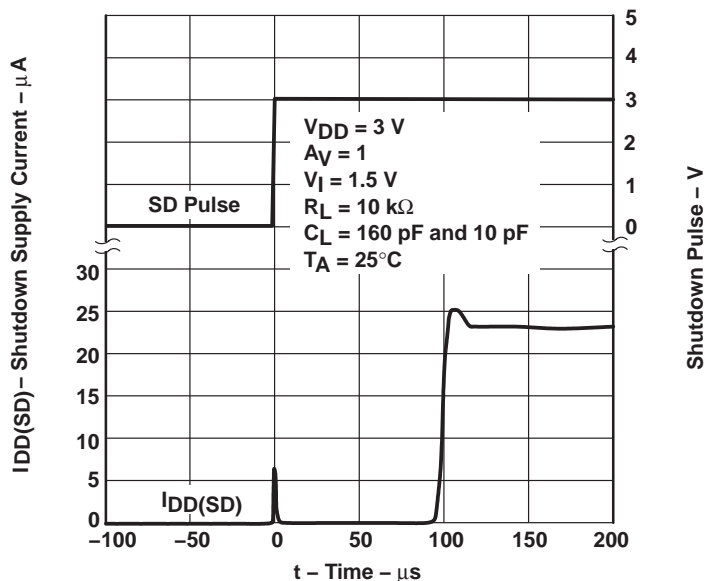

**Figure 39**



TLV2450, TLV2451, TLV2452, TLV2453, TLV2454, TLV2455, TLV245xA  
 FAMILY OF 23- $\mu$ A 220-kHz RAIL-TO-RAIL INPUT/OUTPUT  
 OPERATIONAL AMPLIFIERS WITH SHUTDOWN

SLOS218F – DECEMBER 1998 – REVISED JANUARY 2005

TYPICAL CHARACTERISTICS

SHUTDOWN SUPPLY CURRENT AND SHUTDOWN PULSE  
 vs  
 TIME

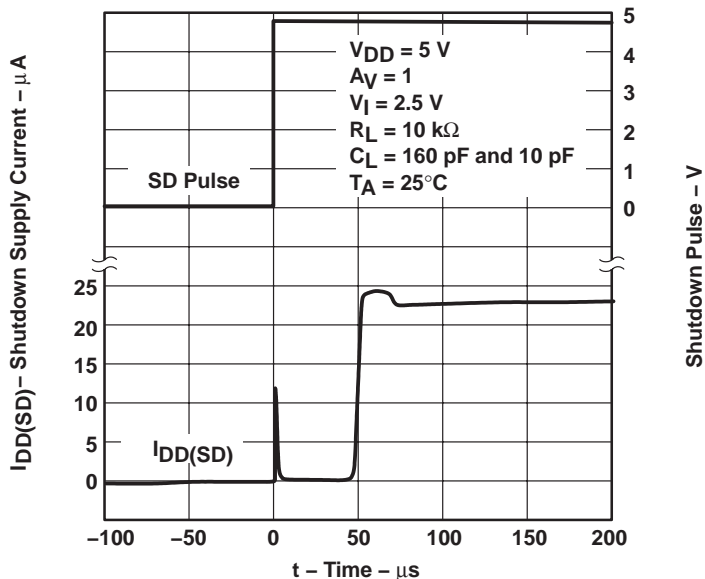

Figure 40

SHUTDOWN SUPPLY CURRENT AND SHUTDOWN PULSE  
 vs  
 TIME

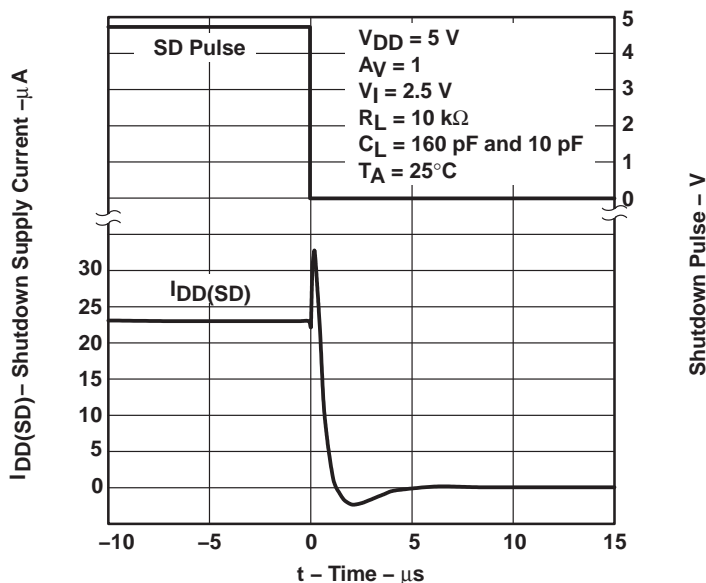

Figure 41

**TLV2450, TLV2451, TLV2452, TLV2453, TLV2454, TLV2455, TLV245xA**  
**FAMILY OF 23- $\mu$ A 220-kHz RAIL-TO-RAIL INPUT/OUTPUT**  
**OPERATIONAL AMPLIFIERS WITH SHUTDOWN**

SLOS218F – DECEMBER 1998 – REVISED JANUARY 2005

**TYPICAL CHARACTERISTICS**

**SHUTDOWN OFF PULSE RESPONSE**  
**VS**  
**TIME**

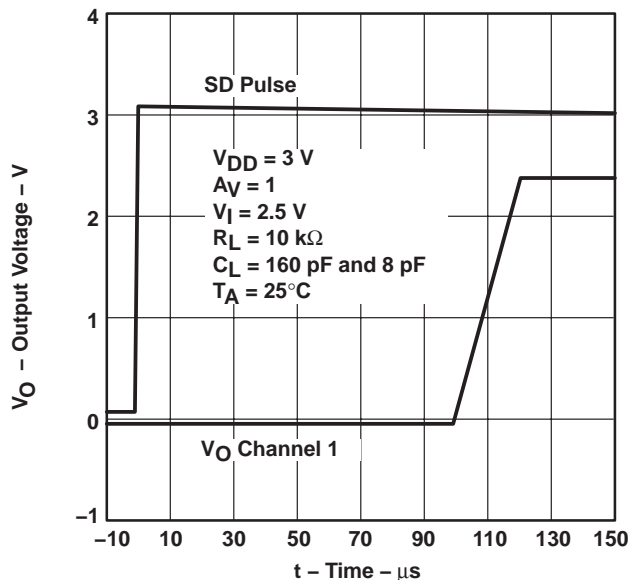

**Figure 42**

**SHUTDOWN OFF PULSE RESPONSE**  
**VS**  
**TIME**

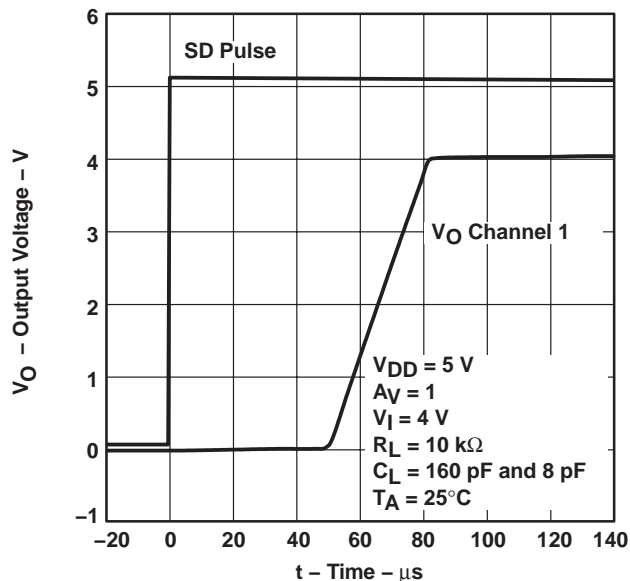

**Figure 43**

**SHUTDOWN ON PULSE RESPONSE**  
**VS**  
**TIME**

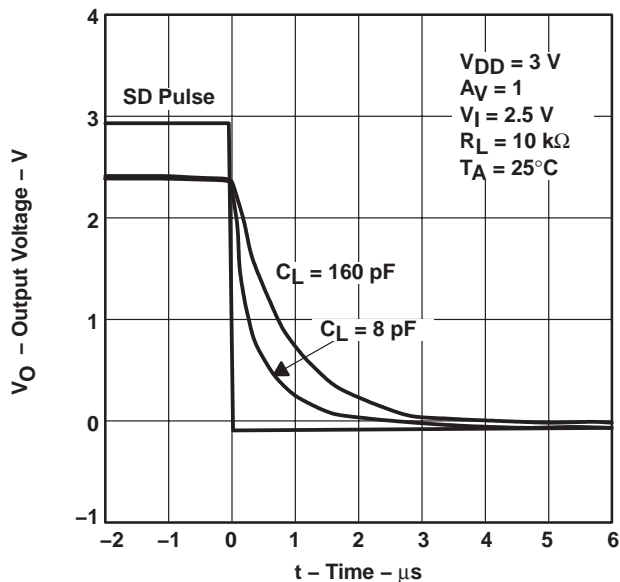

**Figure 44**

**SHUTDOWN ON PULSE RESPONSE**  
**VS**  
**TIME**

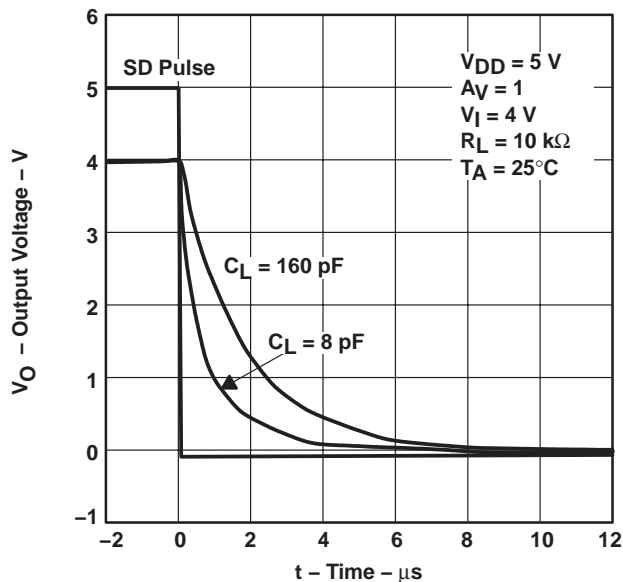

**Figure 45**





TLV2450, TLV2451, TLV2452, TLV2453, TLV2454, TLV2455, TLV245xA  
 FAMILY OF 23- $\mu$ A 220-kHz RAIL-TO-RAIL INPUT/OUTPUT  
 OPERATIONAL AMPLIFIERS WITH SHUTDOWN

SLOS218F – DECEMBER 1998 – REVISED JANUARY 2005

TYPICAL CHARACTERISTICS

SHUTDOWN REVERSE ISOLATION  
 VS  
 FREQUENCY

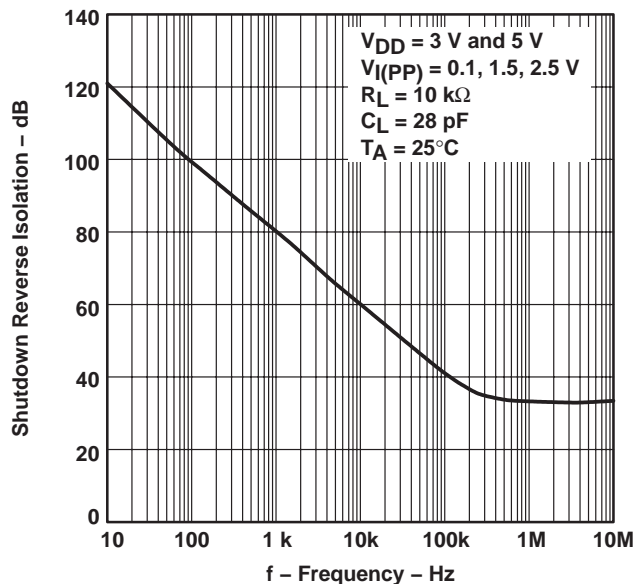

SHUTDOWN FORWARD ISOLATION  
 VS  
 FREQUENCY

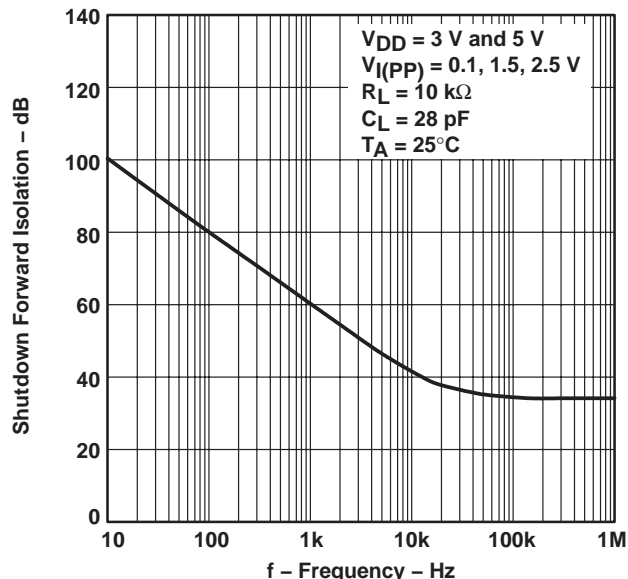

PARAMETER MEASUREMENT INFORMATION

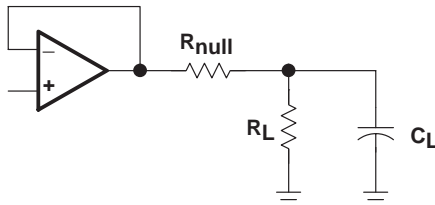

Figure 48

# TLV2450, TLV2451, TLV2452, TLV2453, TLV2454, TLV2455, TLV245xA FAMILY OF 23- $\mu$ A 220-kHz RAIL-TO-RAIL INPUT/OUTPUT OPERATIONAL AMPLIFIERS WITH SHUTDOWN

SLOS218F – DECEMBER 1998 – REVISED JANUARY 2005

## APPLICATION INFORMATION

### shutdown function

Three members of the TLV245x family (TLV2450/3/5) have a shutdown terminal for conserving battery life in portable applications. When the shutdown terminal is pulled to the voltage level on the GND terminal of the device, the supply current is reduced to 16 nA/channel, the amplifier is disabled, and the outputs are placed in a high impedance mode. To enable the amplifier, the shutdown terminal must be pulled high. The shutdown terminal should never be left floating. The shutdown terminal threshold is always referenced to the GND terminal of the device. Therefore, when operating the device with split supply voltages (e.g.  $\pm 2.5$  V), the shutdown terminal needs to be pulled to  $V_{DD-}$  (not system ground) to disable the operational amplifier.

The amplifier's output with a shutdown pulse is shown in Figures 42, 43, 44, and 45. The amplifier is powered with a single 5-V supply and configured as a noninverting configuration with a gain of 5. The amplifier turnon and turnoff times are measured from the 50% point of the shutdown pulse to the 50% point of the output waveform. The times for the single, dual, and quad are listed in the data tables.

Figures 46 and 47 show the amplifier's forward and reverse isolation in shutdown. The operational amplifier is powered by  $\pm 1.35$ -V supplies and configured as a voltage follower ( $A_V = 1$ ). The isolation performance is plotted across frequency using 0.1- $V_{PP}$ , 1.5- $V_{PP}$ , and 2.5- $V_{PP}$  input signals. During normal operation, the amplifier would not be able to handle a 2.5- $V_{PP}$  input signal with a supply voltage of  $\pm 1.35$  V since it exceeds the common-mode input voltage range ( $V_{ICR}$ ). However, this curve illustrates that the amplifier remains in shutdown even under a worst case scenario.

### driving a capacitive load

When the amplifier is configured in this manner, capacitive loading directly on the output will decrease the device's phase margin leading to high frequency ringing or oscillations. Therefore, for capacitive loads of greater than 10 pF, it is recommended that a resistor be placed in series ( $R_{NULL}$ ) with the output of the amplifier, as shown in Figure 49. A minimum value of 20  $\Omega$  should work well for most applications.

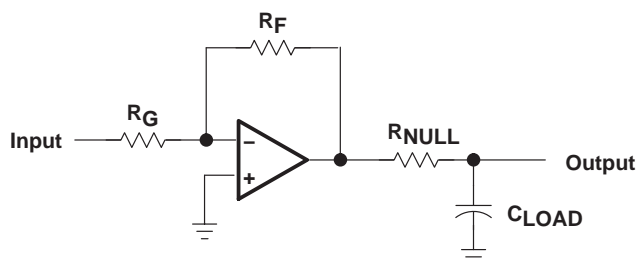

Figure 49. Driving a Capacitive Load

## APPLICATION INFORMATION

### offset voltage

The output offset voltage, ( $V_{OO}$ ) is the sum of the input offset voltage ( $V_{IO}$ ) and both input bias currents ( $I_{IB}$ ) times the corresponding gains. The following schematic and formula can be used to calculate the output offset voltage:

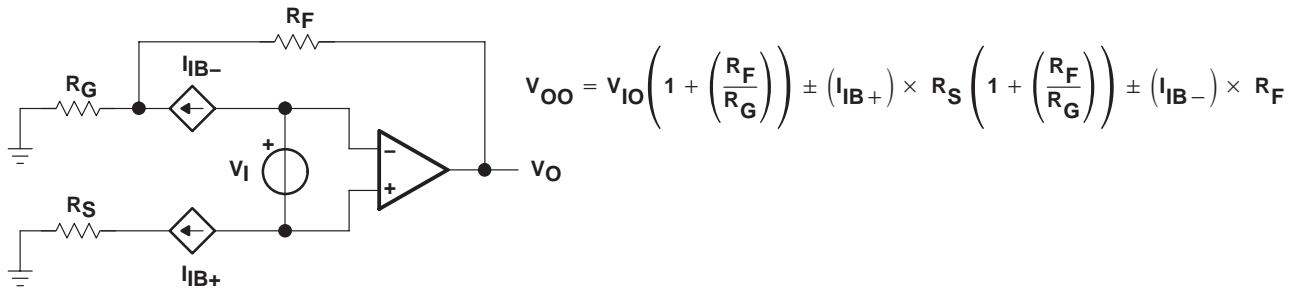

Figure 50. Output Offset Voltage Model

### general configurations

When receiving low-level signals, limiting the bandwidth of the incoming signals into the system is often required. The simplest way to accomplish this is to place an RC filter at the noninverting terminal of the amplifier (see Figure 51).

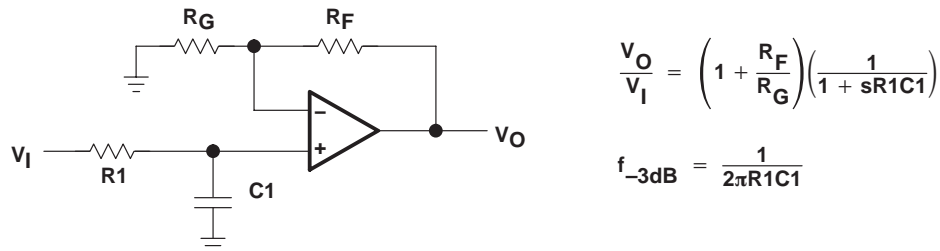

Figure 51. Single-Pole Low-Pass Filter

If even more attenuation is needed, a multiple pole filter is required. The Sallen-Key filter can be used for this task. For best results, the amplifier should have a bandwidth that is 8 to 10 times the filter frequency bandwidth. Failure to do this can result in phase shift of the amplifier.

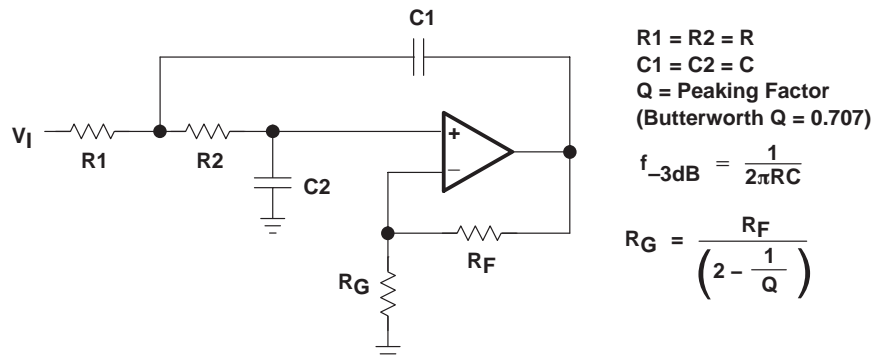

Figure 52. 2-Pole Low-Pass Sallen-Key Filter

**TLV2450, TLV2451, TLV2452, TLV2453, TLV2454, TLV2455, TLV245xA**  
**FAMILY OF 23- $\mu$ A 220-kHz RAIL-TO-RAIL INPUT/OUTPUT**  
**OPERATIONAL AMPLIFIERS WITH SHUTDOWN**

SLOS218F – DECEMBER 1998 – REVISED JANUARY 2005

**APPLICATION INFORMATION**

**general power dissipation considerations**

For a given  $\theta_{JA}$ , the maximum power dissipation is shown in Figure 53 and is calculated by the following formula:

$$P_D = \left( \frac{T_{MAX} - T_A}{\theta_{JA}} \right)$$

Where:

- $P_D$  = Maximum power dissipation of TLV245x IC (watts)
- $T_{MAX}$  = Absolute maximum junction temperature (150°C)
- $T_A$  = Free-ambient air temperature (°C)
- $\theta_{JA}$  =  $\theta_{JC} + \theta_{CA}$
- $\theta_{JC}$  = Thermal coefficient from junction to case
- $\theta_{CA}$  = Thermal coefficient from case to ambient air (°C/W)

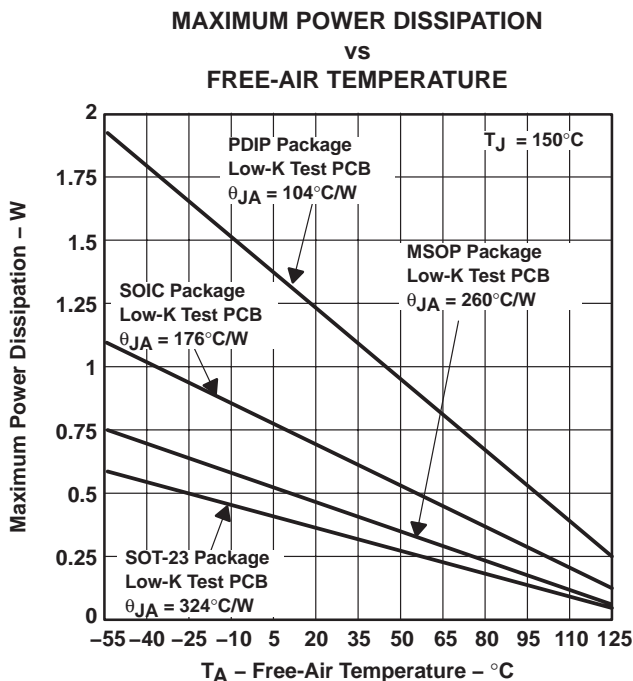

NOTE A: Results are with no air flow and using JEDEC Standard Low-K test PCB.

**Figure 53. Maximum Power Dissipation vs Free-Air Temperature**



# TLV2450, TLV2451, TLV2452, TLV2453, TLV2454, TLV2455, TLV245xA FAMILY OF 23- $\mu$ A 220-KHz RAIL-TO-RAIL INPUT/OUTPUT OPERATIONAL AMPLIFIERS WITH SHUTDOWN

SLOS218F – DECEMBER 1998 – REVISED JANUARY 2005

## APPLICATION INFORMATION

### macromodel information

Macromodel information provided was derived using Microsim *Parts*<sup>™</sup>, the model generation software used with Microsim *PSpice*<sup>™</sup>. The Boyle macromodel (see Note 1) and subcircuit in Figure 54 are generated using the TLV245x typical electrical and operating characteristics at  $T_A = 25^\circ\text{C}$ . Using this information, output simulations of the following key parameters can be generated to a tolerance of 20% (in most cases):

- Maximum positive output voltage swing
- Maximum negative output voltage swing
- Slew rate
- Quiescent power dissipation
- Input bias current
- Open-loop voltage amplification
- Unity-gain frequency
- Common-mode rejection ratio
- Phase margin
- DC output resistance
- AC output resistance
- Short-circuit output current limit

NOTE 1: G. R. Boyle, B. M. Cohn, D. O. Pederson, and J. E. Solomon, "Macromodeling of Integrated Circuit Operational Amplifiers," *IEEE Journal of Solid-State Circuits*, SC-9, 353 (1974).

*PSpice* and *Parts* are trademarks of MicroSim Corporation.



# TLV2450, TLV2451, TLV2452, TLV2453, TLV2454, TLV2455, TLV245xA FAMILY OF 23- $\mu$ A 220-kHz RAIL-TO-RAIL INPUT/OUTPUT OPERATIONAL AMPLIFIERS WITH SHUTDOWN

SLOS218F – DECEMBER 1998 – REVISED JANUARY 2005

## APPLICATION INFORMATION

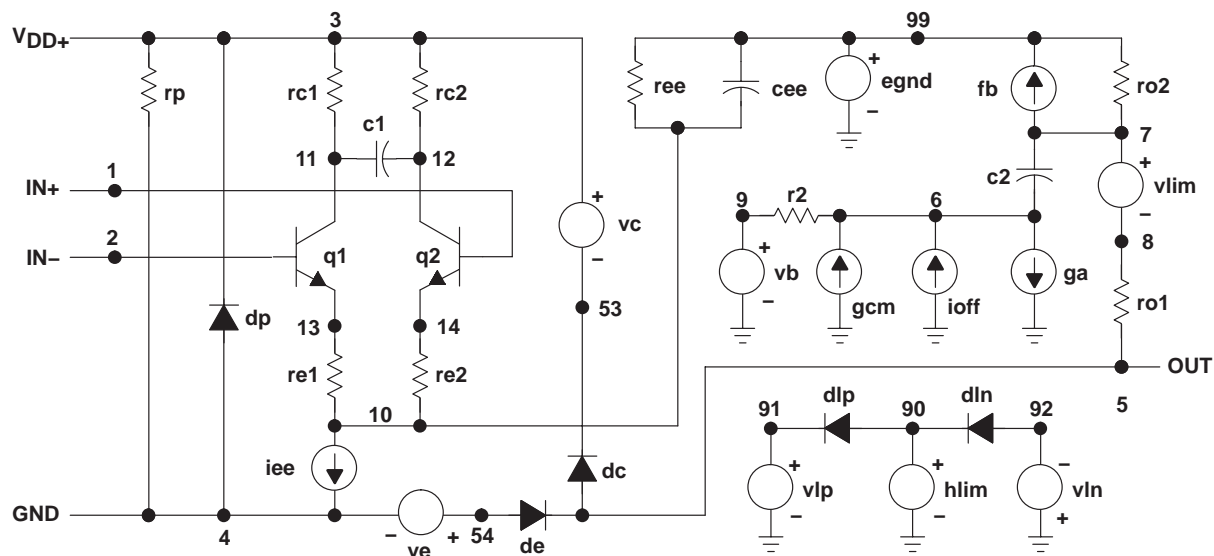

\* AMP\_TLV2450-X operational amplifier "macromodel" subcircuit  
\* created using Parts release 8.0 on 10/12/98 at 11:06  
\* Parts is a MicroSim product.

\* connections:           noninverting input  
\*                            |    inverting input  
\*                            |    positive power supply  
\*                            |    negative power supply  
\*                            |    output  
\*                            |

.subckt AMP\_TLV2450-X 1 2 3 4 5

C1	11	12	354.48E-15
C2	6	7	7.5000E-12
CEE	10	99	42.237E-15
DC	5	53	dy
DE	54	5	dy
DLP	90	91	dx
DLN	92	90	dx
DP	4	3	dx
EGND	99	0	poly(2) (3,0) (4,0) 0 .5 .5
FB	7	99	poly(5) vb vc ve vlp vln 0
+ 207.31E6 -1E3 1E3 210E6 -210E6			
GA	6	0	11 12 15.254E-6
GCM	0	6	10 99 48.237E-12

IEE	10	4	dc	938.61E-9
HLIM	90	0	vlim	1K
Q1	11	2	13	qx1
Q2	12	1	14	qx2
R2	6	9	100.00E3	
RC1	3	11	65.557E3	
RC2	3	12	65.557E3	
RE1	13	10	10.367E3	
RE2	14	10	10.367E3	
REE	10	99	213.08E6	
RO1	8	5	10	
RO2	7	99	10	
RP	3	4	147.06	
VB	9	0	dc	0
VC	3	53	dc	.82
VE	54	4	dc	.82
VLIM	7	8	dc	0
VLP	91	0	dc	38
VLN	0	92	dc	38
.model	dx	D(Is=800.00E-18)		
.model	dy	D(Is=800.00E-18 Rs=1m Cjo=10p)		
.model	qx1	NPN(Is=800.00E-18 Bf=843.08)		
.model	qx2	NPN(Is=800.0000E-18 Bf=843.08)		
.ends				

Figure 54. Boyle Macromodel and Subcircuit

**PACKAGING INFORMATION**

Orderable Device	Status (1)	Package Type	Package Drawing	Pins	Package Qty	Eco Plan (2)	Lead finish/ Ball material (6)	MSL Peak Temp (3)	Op Temp (°C)	Device Marking (4/5)	Samples
TLV2450AIDR	ACTIVE	SOIC	D	8	2500	RoHS & Green	NIPDAU	Level-1-260C-UNLIM	-40 to 125	2450AI	<a href="#">Samples</a>
TLV2450AIP	ACTIVE	PDIP	P	8	50	RoHS & Green	NIPDAU	N / A for Pkg Type	-40 to 125	TLV2450AI	<a href="#">Samples</a>
TLV2450CD	ACTIVE	SOIC	D	8	75	RoHS & Green	NIPDAU	Level-1-260C-UNLIM	0 to 70	2450C	<a href="#">Samples</a>
TLV2450CDBVR	ACTIVE	SOT-23	DBV	6	3000	RoHS & Green	NIPDAU	Level-1-260C-UNLIM	0 to 70	VAQC	<a href="#">Samples</a>
TLV2450CDBVRG4	ACTIVE	SOT-23	DBV	6	3000	RoHS & Green	NIPDAU	Level-1-260C-UNLIM	0 to 70	VAQC	<a href="#">Samples</a>
TLV2450CDBVT	ACTIVE	SOT-23	DBV	6	250	RoHS & Green	NIPDAU	Level-1-260C-UNLIM	0 to 70	VAQC	<a href="#">Samples</a>
TLV2450CP	ACTIVE	PDIP	P	8	50	RoHS & Green	NIPDAU	N / A for Pkg Type	0 to 70	TLV2450C	<a href="#">Samples</a>
TLV2450ID	ACTIVE	SOIC	D	8	75	RoHS & Green	NIPDAU	Level-1-260C-UNLIM	-40 to 125	2450I	<a href="#">Samples</a>
TLV2450IDBVR	ACTIVE	SOT-23	DBV	6	3000	RoHS & Green	NIPDAU	Level-1-260C-UNLIM	-40 to 125	VAQI	<a href="#">Samples</a>
TLV2450IDBVT	ACTIVE	SOT-23	DBV	6	250	RoHS & Green	NIPDAU	Level-1-260C-UNLIM	-40 to 125	VAQI	<a href="#">Samples</a>
TLV2451AID	ACTIVE	SOIC	D	8	75	RoHS & Green	NIPDAU	Level-1-260C-UNLIM	-40 to 125	2451AI	<a href="#">Samples</a>
TLV2451AIDR	ACTIVE	SOIC	D	8	2500	RoHS & Green	NIPDAU	Level-1-260C-UNLIM	-40 to 125	2451AI	<a href="#">Samples</a>
TLV2451AIP	ACTIVE	PDIP	P	8	50	RoHS & Green	NIPDAU	N / A for Pkg Type	-40 to 125	TLV2451AI	<a href="#">Samples</a>
TLV2451CD	ACTIVE	SOIC	D	8	75	RoHS & Green	NIPDAU	Level-1-260C-UNLIM	0 to 70	2451C	<a href="#">Samples</a>
TLV2451CDBVR	ACTIVE	SOT-23	DBV	5	3000	RoHS & Green	NIPDAU	Level-1-260C-UNLIM	0 to 70	VARC	<a href="#">Samples</a>
TLV2451CDBVRG4	ACTIVE	SOT-23	DBV	5	3000	RoHS & Green	NIPDAU	Level-1-260C-UNLIM	0 to 70	VARC	<a href="#">Samples</a>
TLV2451CDBVT	ACTIVE	SOT-23	DBV	5	250	RoHS & Green	NIPDAU	Level-1-260C-UNLIM	0 to 70	VARC	<a href="#">Samples</a>
TLV2451CDG4	ACTIVE	SOIC	D	8	75	RoHS & Green	NIPDAU	Level-1-260C-UNLIM	0 to 70	2451C	<a href="#">Samples</a>
TLV2451CDR	ACTIVE	SOIC	D	8	2500	RoHS & Green	NIPDAU	Level-1-260C-UNLIM	0 to 70	2451C	<a href="#">Samples</a>
TLV2451CP	ACTIVE	PDIP	P	8	50	RoHS & Green	NIPDAU	N / A for Pkg Type	0 to 70	TLV2451C	<a href="#">Samples</a>

Orderable Device	Status (1)	Package Type	Package Drawing	Pins	Package Qty	Eco Plan (2)	Lead finish/ Ball material (6)	MSL Peak Temp (3)	Op Temp (°C)	Device Marking (4/5)	Samples
TLV2451ID	ACTIVE	SOIC	D	8	75	RoHS & Green	NIPDAU	Level-1-260C-UNLIM	-40 to 125	2451I	<a href="#">Samples</a>
TLV2451IDBVR	ACTIVE	SOT-23	DBV	5	3000	RoHS & Green	NIPDAU	Level-1-260C-UNLIM	-40 to 125	VARI	<a href="#">Samples</a>
TLV2451IDBVT	ACTIVE	SOT-23	DBV	5	250	RoHS & Green	NIPDAU	Level-1-260C-UNLIM	-40 to 125	VARI	<a href="#">Samples</a>
TLV2451IDR	ACTIVE	SOIC	D	8	2500	RoHS & Green	NIPDAU	Level-1-260C-UNLIM	-40 to 125	2451I	<a href="#">Samples</a>
TLV2451IP	ACTIVE	PDIP	P	8	50	RoHS & Green	NIPDAU	N / A for Pkg Type	-40 to 125	TLV2451I	<a href="#">Samples</a>
TLV2452AID	ACTIVE	SOIC	D	8	75	RoHS & Green	NIPDAU	Level-1-260C-UNLIM	-40 to 125	2452AI	<a href="#">Samples</a>
TLV2452AIDR	ACTIVE	SOIC	D	8	2500	RoHS & Green	NIPDAU	Level-1-260C-UNLIM	-40 to 125	2452AI	<a href="#">Samples</a>
TLV2452AIP	ACTIVE	PDIP	P	8	50	RoHS & Green	NIPDAU	N / A for Pkg Type	-40 to 125	TLV2452AI	<a href="#">Samples</a>
TLV2452CD	ACTIVE	SOIC	D	8	75	RoHS & Green	NIPDAU	Level-1-260C-UNLIM	0 to 70	2452C	<a href="#">Samples</a>
TLV2452CDGK	ACTIVE	VSSOP	DGK	8	80	RoHS & Green	NIPDAU   NIPDAUAG	Level-1-260C-UNLIM	0 to 70	ABI	<a href="#">Samples</a>
TLV2452CDGKR	ACTIVE	VSSOP	DGK	8	2500	RoHS & Green	NIPDAU   NIPDAUAG	Level-1-260C-UNLIM	0 to 70	ABI	<a href="#">Samples</a>
TLV2452CDR	ACTIVE	SOIC	D	8	2500	RoHS & Green	NIPDAU	Level-1-260C-UNLIM	0 to 70	2452C	<a href="#">Samples</a>
TLV2452ID	ACTIVE	SOIC	D	8	75	RoHS & Green	NIPDAU	Level-1-260C-UNLIM	-40 to 125	2452I	<a href="#">Samples</a>
TLV2452IDGK	ACTIVE	VSSOP	DGK	8	80	RoHS & Green	NIPDAU   NIPDAUAG	Level-1-260C-UNLIM	-40 to 125	ABJ	<a href="#">Samples</a>
TLV2452IDGKR	ACTIVE	VSSOP	DGK	8	2500	RoHS & Green	NIPDAU   NIPDAUAG	Level-1-260C-UNLIM	-40 to 125	ABJ	<a href="#">Samples</a>
TLV2452IDGKRG4	ACTIVE	VSSOP	DGK	8	2500	RoHS & Green	NIPDAU	Level-1-260C-UNLIM	-40 to 125	ABJ	<a href="#">Samples</a>
TLV2452IDR	ACTIVE	SOIC	D	8	2500	RoHS & Green	NIPDAU	Level-1-260C-UNLIM	-40 to 125	2452I	<a href="#">Samples</a>
TLV2452IP	ACTIVE	PDIP	P	8	50	RoHS & Green	NIPDAU	N / A for Pkg Type	-40 to 125	TLV2452IP	<a href="#">Samples</a>
TLV2453CD	ACTIVE	SOIC	D	14	50	RoHS & Green	NIPDAU	Level-1-260C-UNLIM	0 to 70	TLV2453C	<a href="#">Samples</a>
TLV2453CDGSR	ACTIVE	VSSOP	DGS	10	2500	RoHS & Green	NIPDAU	Level-1-260C-UNLIM	0 to 70	ABK	<a href="#">Samples</a>
TLV2453CDR	ACTIVE	SOIC	D	14	2500	RoHS & Green	NIPDAU	Level-1-260C-UNLIM	0 to 70	TLV2453C	<a href="#">Samples</a>



Orderable Device	Status (1)	Package Type	Package Drawing	Pins	Package Qty	Eco Plan (2)	Lead finish/ Ball material (6)	MSL Peak Temp (3)	Op Temp (°C)	Device Marking (4/5)	Samples
TLV2453IDGS	ACTIVE	VSSOP	DGS	10	80	RoHS & Green	NIPDAU	Level-1-260C-UNLIM	-40 to 125	ABL	<a href="#">Samples</a>
TLV2453IDGSG4	ACTIVE	VSSOP	DGS	10	80	RoHS & Green	NIPDAU	Level-1-260C-UNLIM	-40 to 125	ABL	<a href="#">Samples</a>
TLV2453IDGSR	ACTIVE	VSSOP	DGS	10	2500	RoHS & Green	NIPDAU	Level-1-260C-UNLIM	-40 to 125	ABL	<a href="#">Samples</a>
TLV2453IN	ACTIVE	PDIP	N	14	25	RoHS & Green	NIPDAU	N / A for Pkg Type	-40 to 125	TLV2453IN	<a href="#">Samples</a>
TLV2454AID	ACTIVE	SOIC	D	14	50	RoHS & Green	NIPDAU	Level-1-260C-UNLIM	-40 to 125	2454AI	<a href="#">Samples</a>
TLV2454AIDR	ACTIVE	SOIC	D	14	2500	RoHS & Green	NIPDAU	Level-1-260C-UNLIM	-40 to 125	2454AI	<a href="#">Samples</a>
TLV2454AIN	ACTIVE	PDIP	N	14	25	RoHS & Green	NIPDAU	N / A for Pkg Type	-40 to 125	TLV2454AI	<a href="#">Samples</a>
TLV2454AIPW	ACTIVE	TSSOP	PW	14	90	RoHS & Green	NIPDAU	Level-1-260C-UNLIM		TY2454A	<a href="#">Samples</a>
TLV2454AIPWR	ACTIVE	TSSOP	PW	14	2000	RoHS & Green	NIPDAU	Level-1-260C-UNLIM	-40 to 125	TY2454A	<a href="#">Samples</a>
TLV2454CD	ACTIVE	SOIC	D	14	50	RoHS & Green	NIPDAU	Level-1-260C-UNLIM	0 to 70	2454C	<a href="#">Samples</a>
TLV2454CN	ACTIVE	PDIP	N	14	25	RoHS & Green	NIPDAU	N / A for Pkg Type	0 to 70	TLV2454C	<a href="#">Samples</a>
TLV2454CPW	ACTIVE	TSSOP	PW	14	90	RoHS & Green	NIPDAU	Level-1-260C-UNLIM	0 to 70	TV2454	<a href="#">Samples</a>
TLV2454CPWR	ACTIVE	TSSOP	PW	14	2000	RoHS & Green	NIPDAU	Level-1-260C-UNLIM	0 to 70	TV2454	<a href="#">Samples</a>
TLV2454CPWRG4	ACTIVE	TSSOP	PW	14	2000	RoHS & Green	NIPDAU	Level-1-260C-UNLIM	0 to 70	TV2454	<a href="#">Samples</a>
TLV2454ID	ACTIVE	SOIC	D	14	50	RoHS & Green	NIPDAU	Level-1-260C-UNLIM	-40 to 125	2454I	<a href="#">Samples</a>
TLV2454IDR	ACTIVE	SOIC	D	14	2500	RoHS & Green	NIPDAU	Level-1-260C-UNLIM	-40 to 125	2454I	<a href="#">Samples</a>
TLV2454IDRG4	ACTIVE	SOIC	D	14	2500	RoHS & Green	NIPDAU	Level-1-260C-UNLIM	-40 to 125	2454I	<a href="#">Samples</a>
TLV2454IN	ACTIVE	PDIP	N	14	25	RoHS & Green	NIPDAU	N / A for Pkg Type	-40 to 125	TLV2454I	<a href="#">Samples</a>
TLV2454IPW	ACTIVE	TSSOP	PW	14	90	RoHS & Green	NIPDAU	Level-1-260C-UNLIM	-40 to 125	TY2454	<a href="#">Samples</a>
TLV2454IPWR	ACTIVE	TSSOP	PW	14	2000	RoHS & Green	NIPDAU	Level-1-260C-UNLIM	-40 to 125	TY2454	<a href="#">Samples</a>
TLV2455AID	ACTIVE	SOIC	D	16	40	RoHS & Green	NIPDAU	Level-1-260C-UNLIM	-40 to 125	TLV2455AI	<a href="#">Samples</a>

Orderable Device	Status (1)	Package Type	Package Drawing	Pins	Package Qty	Eco Plan (2)	Lead finish/ Ball material (6)	MSL Peak Temp (3)	Op Temp (°C)	Device Marking (4/5)	Samples
TLV2455AIDR	ACTIVE	SOIC	D	16	2500	RoHS & Green	NIPDAU	Level-1-260C-UNLIM	-40 to 125	TLV2455AI	<a href="#">Samples</a>
TLV2455AIN	ACTIVE	PDIP	N	16	25	RoHS & Green	NIPDAU	N / A for Pkg Type	-40 to 125	TLV2455AI	<a href="#">Samples</a>
TLV2455AIPW	ACTIVE	TSSOP	PW	16	90	RoHS & Green	NIPDAU	Level-1-260C-UNLIM	-40 to 125	TY2455A	<a href="#">Samples</a>
TLV2455AIPWR	ACTIVE	TSSOP	PW	16	2000	RoHS & Green	NIPDAU	Level-1-260C-UNLIM	-40 to 125	TY2455A	<a href="#">Samples</a>
TLV2455CD	ACTIVE	SOIC	D	16	40	RoHS & Green	NIPDAU	Level-1-260C-UNLIM	0 to 70	TLV2455C	<a href="#">Samples</a>
TLV2455ID	ACTIVE	SOIC	D	16	40	RoHS & Green	NIPDAU	Level-1-260C-UNLIM	-40 to 125	TLV2455I	<a href="#">Samples</a>
TLV2455IDR	ACTIVE	SOIC	D	16	2500	RoHS & Green	NIPDAU	Level-1-260C-UNLIM	-40 to 125	TLV2455I	<a href="#">Samples</a>
TLV2455IPW	ACTIVE	TSSOP	PW	16	90	RoHS & Green	NIPDAU	Level-1-260C-UNLIM	-40 to 125	TY2455	<a href="#">Samples</a>

(1) The marketing status values are defined as follows:

**ACTIVE:** Product device recommended for new designs.

**LIFEBUY:** TI has announced that the device will be discontinued, and a lifetime-buy period is in effect.

**NRND:** Not recommended for new designs. Device is in production to support existing customers, but TI does not recommend using this part in a new design.

**PREVIEW:** Device has been announced but is not in production. Samples may or may not be available.

**OBSOLETE:** TI has discontinued the production of the device.

(2) **RoHS:** TI defines "RoHS" to mean semiconductor products that are compliant with the current EU RoHS requirements for all 10 RoHS substances, including the requirement that RoHS substance do not exceed 0.1% by weight in homogeneous materials. Where designed to be soldered at high temperatures, "RoHS" products are suitable for use in specified lead-free processes. TI may reference these types of products as "Pb-Free".

**RoHS Exempt:** TI defines "RoHS Exempt" to mean products that contain lead but are compliant with EU RoHS pursuant to a specific EU RoHS exemption.

**Green:** TI defines "Green" to mean the content of Chlorine (Cl) and Bromine (Br) based flame retardants meet JS709B low halogen requirements of <=1000ppm threshold. Antimony trioxide based flame retardants must also meet the <=1000ppm threshold requirement.

(3) MSL, Peak Temp. - The Moisture Sensitivity Level rating according to the JEDEC industry standard classifications, and peak solder temperature.

(4) There may be additional marking, which relates to the logo, the lot trace code information, or the environmental category on the device.

(5) Multiple Device Markings will be inside parentheses. Only one Device Marking contained in parentheses and separated by a "~" will appear on a device. If a line is indented then it is a continuation of the previous line and the two combined represent the entire Device Marking for that device.

<sup>(6)</sup> Lead finish/Ball material - Orderable Devices may have multiple material finish options. Finish options are separated by a vertical ruled line. Lead finish/Ball material values may wrap to two lines if the finish value exceeds the maximum column width.

**Important Information and Disclaimer:**The information provided on this page represents TI's knowledge and belief as of the date that it is provided. TI bases its knowledge and belief on information provided by third parties, and makes no representation or warranty as to the accuracy of such information. Efforts are underway to better integrate information from third parties. TI has taken and continues to take reasonable steps to provide representative and accurate information but may not have conducted destructive testing or chemical analysis on incoming materials and chemicals. TI and TI suppliers consider certain information to be proprietary, and thus CAS numbers and other limited information may not be available for release.

In no event shall TI's liability arising out of such information exceed the total purchase price of the TI part(s) at issue in this document sold by TI to Customer on an annual basis.

## TAPE AND REEL INFORMATION

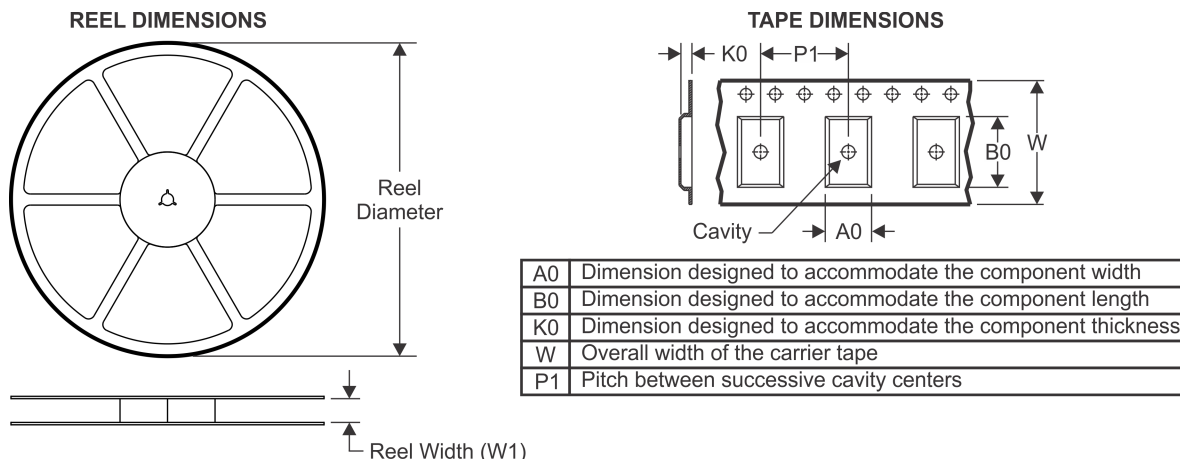

### QUADRANT ASSIGNMENTS FOR PIN 1 ORIENTATION IN TAPE



\*All dimensions are nominal

Device	Package Type	Package Drawing	Pins	SPQ	Reel Diameter (mm)	Reel Width W1 (mm)	A0 (mm)	B0 (mm)	K0 (mm)	P1 (mm)	W (mm)	Pin1 Quadrant
TLV2450AIDR	SOIC	D	8	2500	330.0	12.4	6.4	5.2	2.1	8.0	12.0	Q1
TLV2450CDBVR	SOT-23	DBV	6	3000	180.0	9.0	3.15	3.2	1.4	4.0	8.0	Q3
TLV2450CDBVT	SOT-23	DBV	6	250	180.0	9.0	3.15	3.2	1.4	4.0	8.0	Q3
TLV2450IDBVR	SOT-23	DBV	6	3000	180.0	9.0	3.15	3.2	1.4	4.0	8.0	Q3
TLV2450IDBVT	SOT-23	DBV	6	250	180.0	9.0	3.15	3.2	1.4	4.0	8.0	Q3
TLV2451AIDR	SOIC	D	8	2500	330.0	12.4	6.4	5.2	2.1	8.0	12.0	Q1
TLV2451CDBVR	SOT-23	DBV	5	3000	180.0	9.0	3.15	3.2	1.4	4.0	8.0	Q3
TLV2451CDBVT	SOT-23	DBV	5	250	180.0	9.0	3.15	3.2	1.4	4.0	8.0	Q3
TLV2451CDR	SOIC	D	8	2500	330.0	12.4	6.4	5.2	2.1	8.0	12.0	Q1
TLV2451IDBVR	SOT-23	DBV	5	3000	180.0	9.0	3.15	3.2	1.4	4.0	8.0	Q3
TLV2451IDBVT	SOT-23	DBV	5	250	180.0	9.0	3.15	3.2	1.4	4.0	8.0	Q3
TLV2451IDR	SOIC	D	8	2500	330.0	12.4	6.4	5.2	2.1	8.0	12.0	Q1
TLV2452AIDR	SOIC	D	8	2500	330.0	12.4	6.4	5.2	2.1	8.0	12.0	Q1
TLV2452CDGKR	VSSOP	DGK	8	2500	330.0	12.4	5.3	3.4	1.4	8.0	12.0	Q1
TLV2452CDGKR	VSSOP	DGK	8	2500	330.0	12.4	5.3	3.4	1.4	8.0	12.0	Q1
TLV2452CDR	SOIC	D	8	2500	330.0	12.4	6.4	5.2	2.1	8.0	12.0	Q1
TLV2452IDGKR	VSSOP	DGK	8	2500	330.0	12.4	5.3	3.4	1.4	8.0	12.0	Q1
TLV2452IDGKR	VSSOP	DGK	8	2500	330.0	12.4	5.3	3.4	1.4	8.0	12.0	Q1

Device	Package Type	Package Drawing	Pins	SPQ	Reel Diameter (mm)	Reel Width W1 (mm)	A0 (mm)	B0 (mm)	K0 (mm)	P1 (mm)	W (mm)	Pin1 Quadrant
TLV2452IDR	SOIC	D	8	2500	330.0	12.4	6.4	5.2	2.1	8.0	12.0	Q1
TLV2453CDGSR	VSSOP	DGS	10	2500	330.0	12.4	5.3	3.4	1.4	8.0	12.0	Q1
TLV2453CDR	SOIC	D	14	2500	330.0	16.4	6.5	9.0	2.1	8.0	16.0	Q1
TLV2453IDGSR	VSSOP	DGS	10	2500	330.0	12.4	5.3	3.4	1.4	8.0	12.0	Q1
TLV2454AIDR	SOIC	D	14	2500	330.0	16.4	6.5	9.0	2.1	8.0	16.0	Q1
TLV2454AIPWR	TSSOP	PW	14	2000	330.0	12.4	6.9	5.6	1.6	8.0	12.0	Q1
TLV2454CPWR	TSSOP	PW	14	2000	330.0	12.4	6.9	5.6	1.6	8.0	12.0	Q1
TLV2454IDR	SOIC	D	14	2500	330.0	16.4	6.5	9.0	2.1	8.0	16.0	Q1
TLV2454IPWR	TSSOP	PW	14	2000	330.0	12.4	6.9	5.6	1.6	8.0	12.0	Q1
TLV2455AIDR	SOIC	D	16	2500	330.0	16.4	6.5	10.3	2.1	8.0	16.0	Q1
TLV2455AIPWR	TSSOP	PW	16	2000	330.0	12.4	6.9	5.6	1.6	8.0	12.0	Q1
TLV2455IDR	SOIC	D	16	2500	330.0	16.4	6.5	10.3	2.1	8.0	16.0	Q1

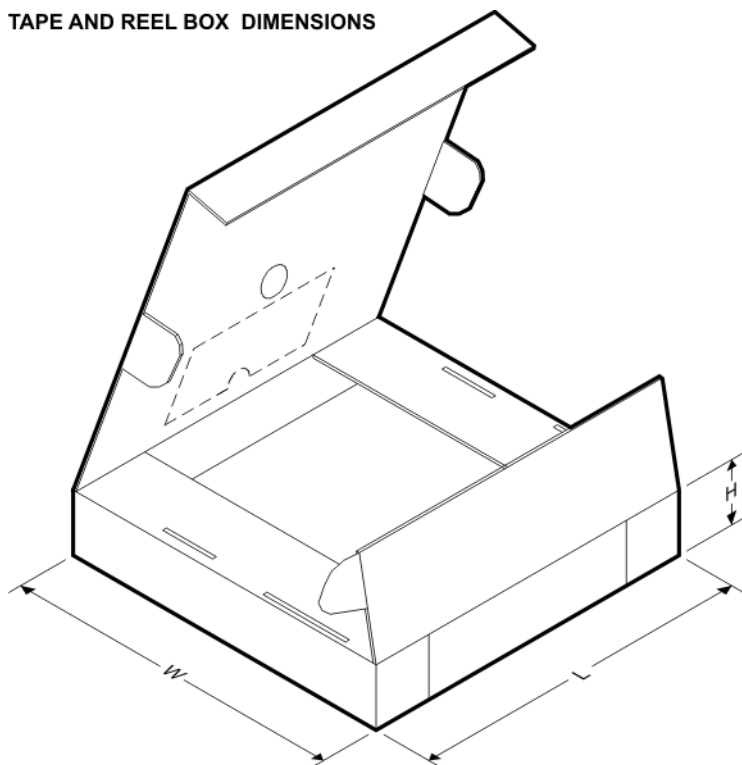
**TAPE AND REEL BOX DIMENSIONS**

\*All dimensions are nominal

Device	Package Type	Package Drawing	Pins	SPQ	Length (mm)	Width (mm)	Height (mm)
TLV2450AIDR	SOIC	D	8	2500	340.5	336.1	25.0
TLV2450CDBVR	SOT-23	DBV	6	3000	182.0	182.0	20.0
TLV2450CDBVT	SOT-23	DBV	6	250	182.0	182.0	20.0
TLV2450IDBVR	SOT-23	DBV	6	3000	182.0	182.0	20.0
TLV2450IDBVT	SOT-23	DBV	6	250	182.0	182.0	20.0

Device	Package Type	Package Drawing	Pins	SPQ	Length (mm)	Width (mm)	Height (mm)
TLV2451AIDR	SOIC	D	8	2500	340.5	336.1	25.0
TLV2451CDBVR	SOT-23	DBV	5	3000	182.0	182.0	20.0
TLV2451CDBVT	SOT-23	DBV	5	250	182.0	182.0	20.0
TLV2451CDR	SOIC	D	8	2500	340.5	336.1	25.0
TLV2451IDBVR	SOT-23	DBV	5	3000	182.0	182.0	20.0
TLV2451IDBVT	SOT-23	DBV	5	250	182.0	182.0	20.0
TLV2451IDR	SOIC	D	8	2500	340.5	336.1	25.0
TLV2452AIDR	SOIC	D	8	2500	340.5	336.1	25.0
TLV2452CDGKR	VSSOP	DGK	8	2500	358.0	335.0	35.0
TLV2452CDGKR	VSSOP	DGK	8	2500	364.0	364.0	27.0
TLV2452CDR	SOIC	D	8	2500	340.5	336.1	25.0
TLV2452IDGKR	VSSOP	DGK	8	2500	358.0	335.0	35.0
TLV2452IDGKR	VSSOP	DGK	8	2500	364.0	364.0	27.0
TLV2452IDR	SOIC	D	8	2500	340.5	336.1	25.0
TLV2453CDGSR	VSSOP	DGS	10	2500	358.0	335.0	35.0
TLV2453CDR	SOIC	D	14	2500	350.0	350.0	43.0
TLV2453IDGSR	VSSOP	DGS	10	2500	358.0	335.0	35.0
TLV2454AIDR	SOIC	D	14	2500	350.0	350.0	43.0
TLV2454AIPWR	TSSOP	PW	14	2000	853.0	449.0	35.0
TLV2454CPWR	TSSOP	PW	14	2000	853.0	449.0	35.0
TLV2454IDR	SOIC	D	14	2500	350.0	350.0	43.0
TLV2454IPWR	TSSOP	PW	14	2000	853.0	449.0	35.0
TLV2455AIDR	SOIC	D	16	2500	350.0	350.0	43.0
TLV2455AIPWR	TSSOP	PW	16	2000	853.0	449.0	35.0
TLV2455IDR	SOIC	D	16	2500	350.0	350.0	43.0

# DBV0005A



## PACKAGE OUTLINE

SOT-23 - 1.45 mm max height

SMALL OUTLINE TRANSISTOR

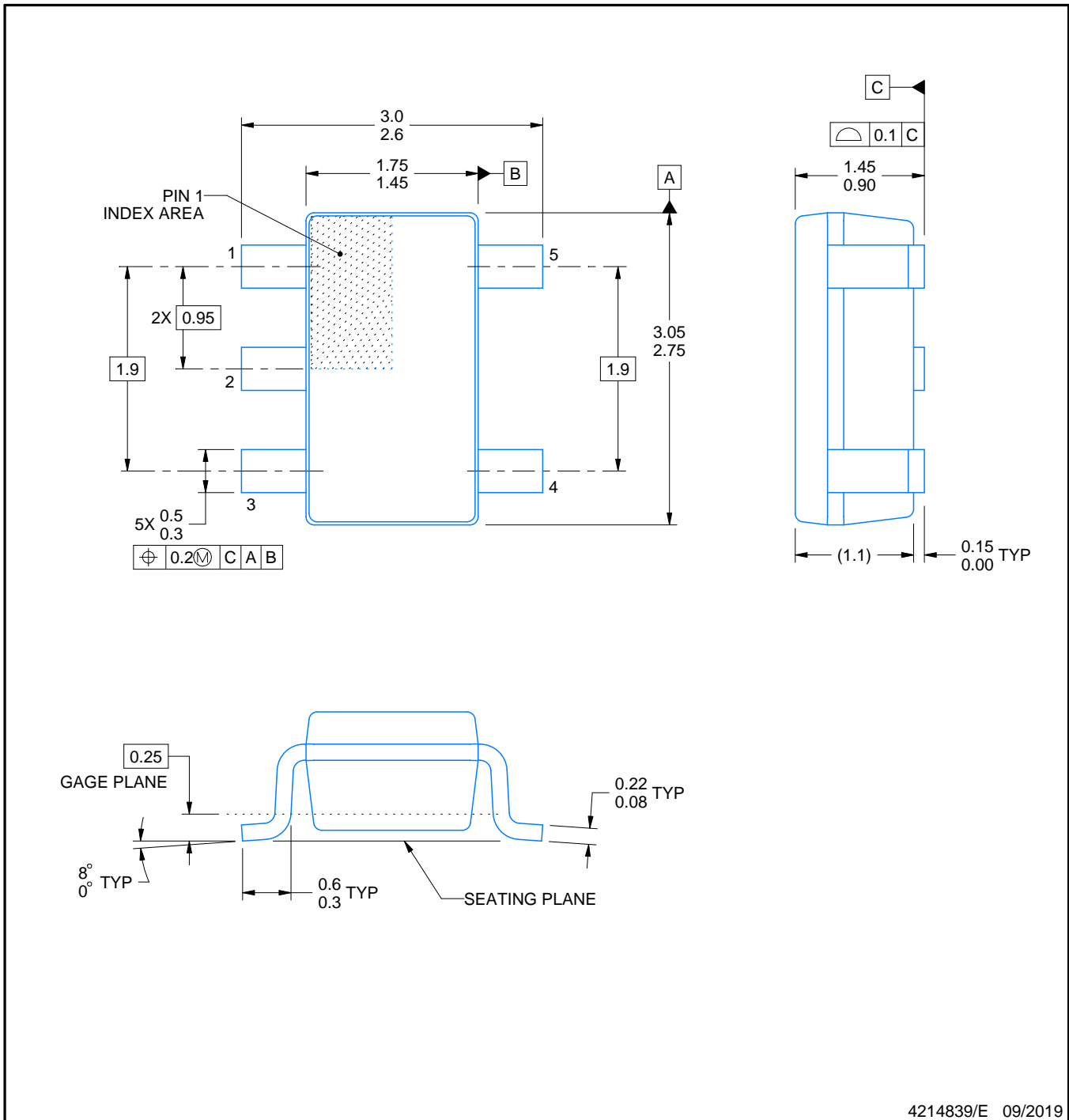

4214839/E 09/2019

**NOTES:**

1. All linear dimensions are in millimeters. Any dimensions in parenthesis are for reference only. Dimensioning and tolerancing per ASME Y14.5M.
2. This drawing is subject to change without notice.
3. Reference JEDEC MO-178.
4. Body dimensions do not include mold flash, protrusions, or gate burrs. Mold flash, protrusions, or gate burrs shall not exceed 0.15 mm per side.

# EXAMPLE BOARD LAYOUT

DBV0005A

SOT-23 - 1.45 mm max height

SMALL OUTLINE TRANSISTOR



LAND PATTERN EXAMPLE  
EXPOSED METAL SHOWN  
SCALE:15X

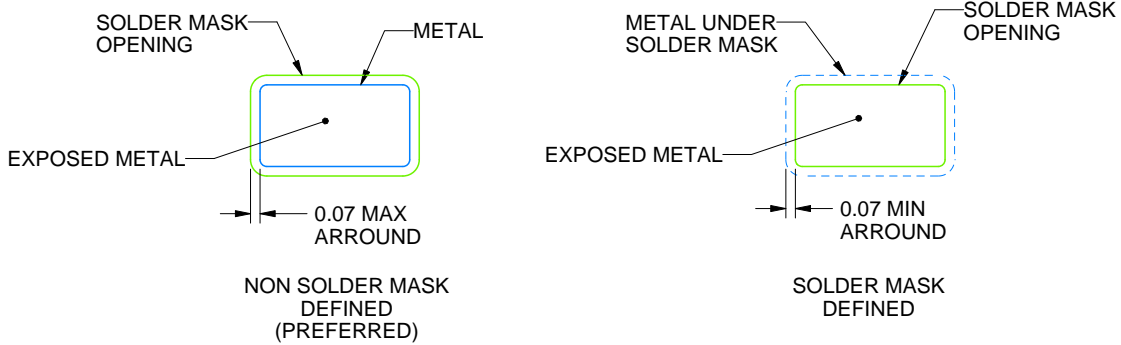

SOLDER MASK DETAILS

4214839/E 09/2019

NOTES: (continued)

- 5. Publication IPC-7351 may have alternate designs.
- 6. Solder mask tolerances between and around signal pads can vary based on board fabrication site.



# EXAMPLE STENCIL DESIGN

DBV0005A

SOT-23 - 1.45 mm max height

SMALL OUTLINE TRANSISTOR



SOLDER PASTE EXAMPLE  
BASED ON 0.125 mm THICK STENCIL  
SCALE:15X

4214839/E 09/2019

NOTES: (continued)

7. Laser cutting apertures with trapezoidal walls and rounded corners may offer better paste release. IPC-7525 may have alternate design recommendations.
8. Board assembly site may have different recommendations for stencil design.

# DBV0005A



# PACKAGE OUTLINE

SOT-23 - 1.45 mm max height

SMALL OUTLINE TRANSISTOR

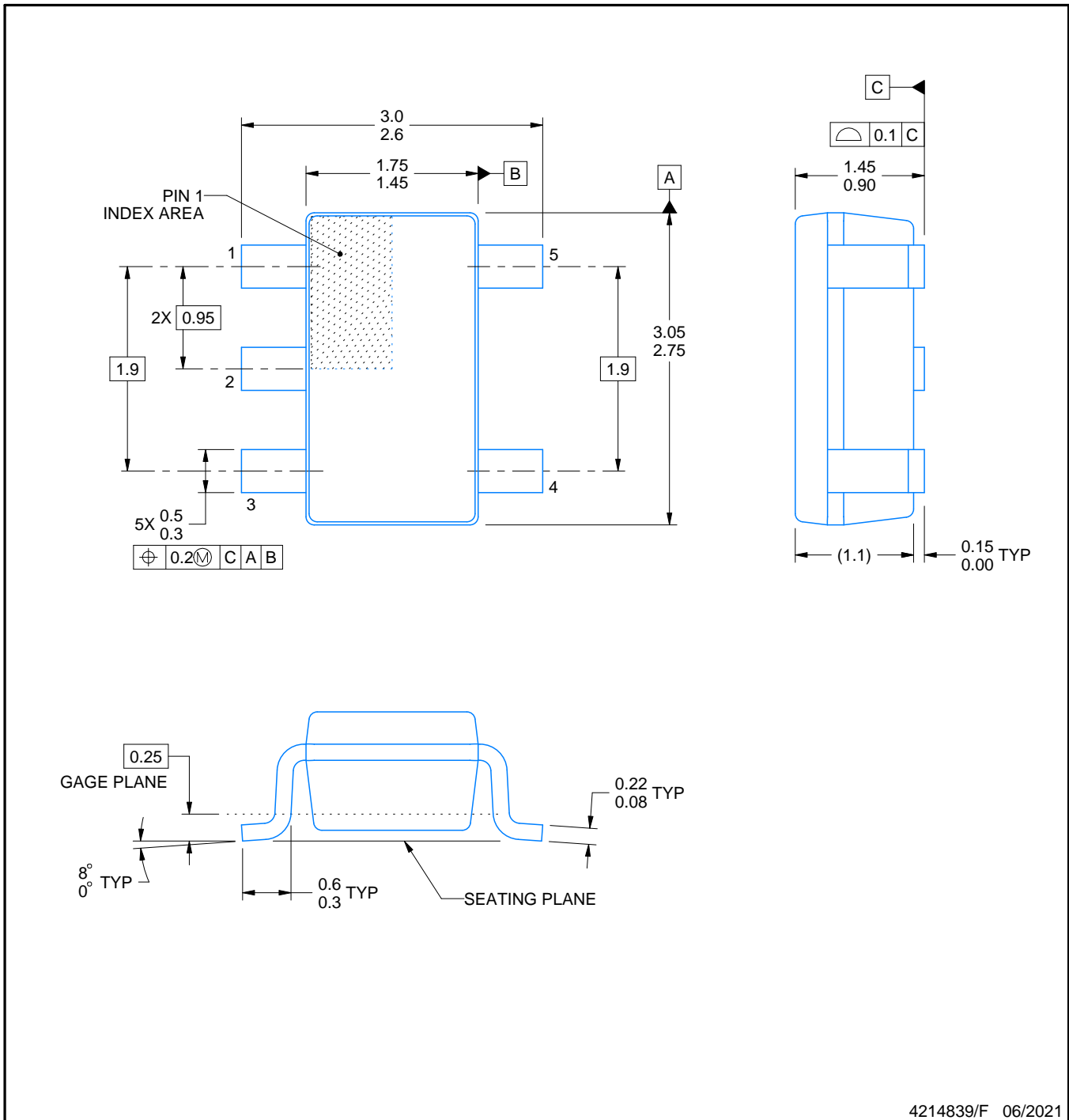

## NOTES:

1. All linear dimensions are in millimeters. Any dimensions in parenthesis are for reference only. Dimensioning and tolerancing per ASME Y14.5M.
2. This drawing is subject to change without notice.
3. Reference JEDEC MO-178.
4. Body dimensions do not include mold flash, protrusions, or gate burrs. Mold flash, protrusions, or gate burrs shall not exceed 0.25 mm per side.

# EXAMPLE BOARD LAYOUT

DBV0005A

SOT-23 - 1.45 mm max height

SMALL OUTLINE TRANSISTOR



LAND PATTERN EXAMPLE  
EXPOSED METAL SHOWN  
SCALE:15X



SOLDER MASK DETAILS

4214839/F 06/2021

NOTES: (continued)

- 5. Publication IPC-7351 may have alternate designs.
- 6. Solder mask tolerances between and around signal pads can vary based on board fabrication site.

# EXAMPLE STENCIL DESIGN

DBV0005A

SOT-23 - 1.45 mm max height

SMALL OUTLINE TRANSISTOR



SOLDER PASTE EXAMPLE  
BASED ON 0.125 mm THICK STENCIL  
SCALE:15X

4214839/F 06/2021

NOTES: (continued)

7. Laser cutting apertures with trapezoidal walls and rounded corners may offer better paste release. IPC-7525 may have alternate design recommendations.
8. Board assembly site may have different recommendations for stencil design.

# DGS0010A



# PACKAGE OUTLINE

## VSSOP - 1.1 mm max height

SMALL OUTLINE PACKAGE



4221984/A 05/2015

### NOTES:

1. All linear dimensions are in millimeters. Any dimensions in parenthesis are for reference only. Dimensioning and tolerancing per ASME Y14.5M.
2. This drawing is subject to change without notice.
3. This dimension does not include mold flash, protrusions, or gate burrs. Mold flash, protrusions, or gate burrs shall not exceed 0.15 mm per side.
4. This dimension does not include interlead flash. Interlead flash shall not exceed 0.25 mm per side.
5. Reference JEDEC registration MO-187, variation BA.

# EXAMPLE BOARD LAYOUT

DGS0010A

VSSOP - 1.1 mm max height

SMALL OUTLINE PACKAGE



LAND PATTERN EXAMPLE  
SCALE:10X

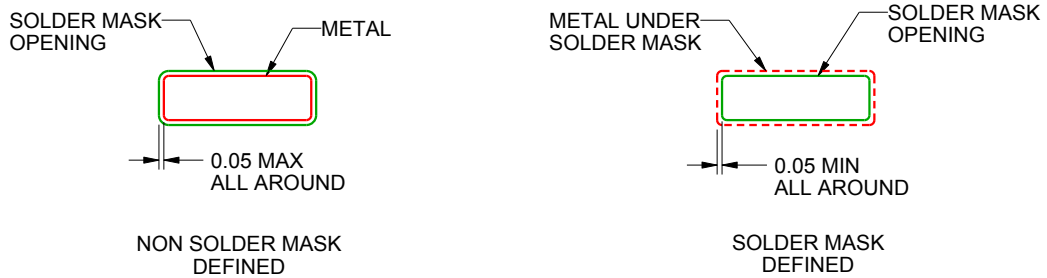

SOLDER MASK DETAILS  
NOT TO SCALE

4221984/A 05/2015

NOTES: (continued)

- 6. Publication IPC-7351 may have alternate designs.
- 7. Solder mask tolerances between and around signal pads can vary based on board fabrication site.

# EXAMPLE STENCIL DESIGN

DGS0010A

VSSOP - 1.1 mm max height

SMALL OUTLINE PACKAGE



SOLDER PASTE EXAMPLE  
BASED ON 0.125 mm THICK STENCIL  
SCALE:10X

4221984/A 05/2015

NOTES: (continued)



8. Laser cutting apertures with trapezoidal walls and rounded corners may offer better paste release. IPC-7525 may have alternate design recommendations.
9. Board assembly site may have different recommendations for stencil design.

D (R-PDSO-G14)

PLASTIC SMALL OUTLINE



4040047-5/M 06/11

- NOTES:
- A. All linear dimensions are in inches (millimeters).
  - B. This drawing is subject to change without notice.
  -  Body length does not include mold flash, protrusions, or gate burrs. Mold flash, protrusions, or gate burrs shall not exceed 0.006 (0,15) each side.
  -  Body width does not include interlead flash. Interlead flash shall not exceed 0.017 (0,43) each side.
  - E. Reference JEDEC MS-012 variation AB.



D (R-PDSO-G14)

PLASTIC SMALL OUTLINE



- NOTES:
- A. All linear dimensions are in millimeters.
  - B. This drawing is subject to change without notice.
  - C. Publication IPC-7351 is recommended for alternate designs.
  - D. Laser cutting apertures with trapezoidal walls and also rounding corners will offer better paste release. Customers should contact their board assembly site for stencil design recommendations. Refer to IPC-7525 for other stencil recommendations.
  - E. Customers should contact their board fabrication site for solder mask tolerances between and around signal pads.

PW (R-PDSO-G14)

PLASTIC SMALL OUTLINE



- NOTES:
- A. All linear dimensions are in millimeters. Dimensioning and tolerancing per ASME Y14.5M-1994.
  - B. This drawing is subject to change without notice.
  - C. Body length does not include mold flash, protrusions, or gate burrs. Mold flash, protrusions, or gate burrs shall not exceed 0,15 each side.
  - D. Body width does not include interlead flash. Interlead flash shall not exceed 0,25 each side.
  - E. Falls within JEDEC MO-153

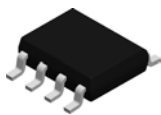

D0008A

# PACKAGE OUTLINE

## SOIC - 1.75 mm max height

SMALL OUTLINE INTEGRATED CIRCUIT

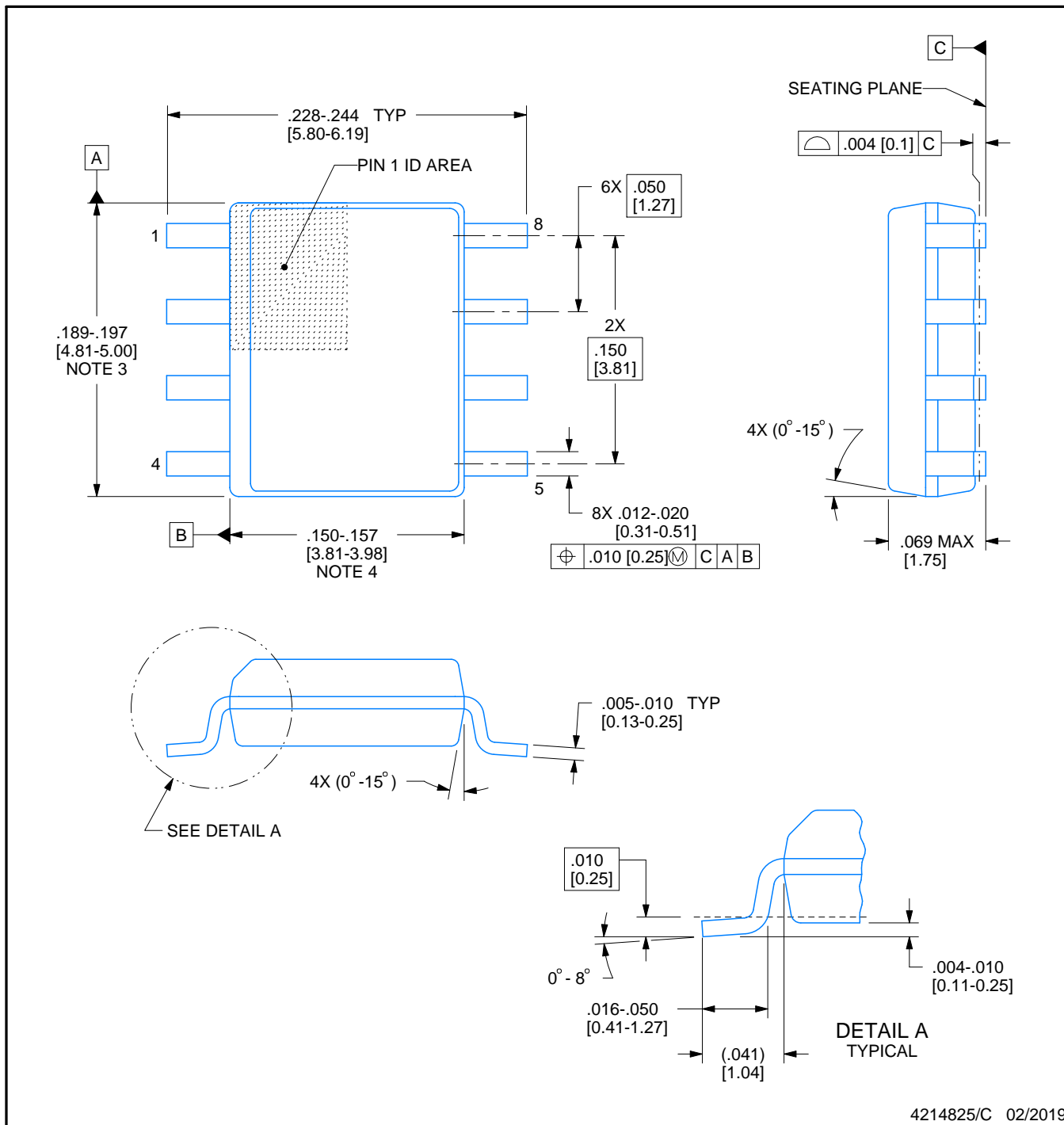

**NOTES:**

1. Linear dimensions are in inches [millimeters]. Dimensions in parenthesis are for reference only. Controlling dimensions are in inches. Dimensioning and tolerancing per ASME Y14.5M.
2. This drawing is subject to change without notice.
3. This dimension does not include mold flash, protrusions, or gate burrs. Mold flash, protrusions, or gate burrs shall not exceed .006 [0.15] per side.
4. This dimension does not include interlead flash.
5. Reference JEDEC registration MS-012, variation AA.

# EXAMPLE BOARD LAYOUT

D0008A

SOIC - 1.75 mm max height

SMALL OUTLINE INTEGRATED CIRCUIT



LAND PATTERN EXAMPLE  
 EXPOSED METAL SHOWN  
 SCALE:8X



SOLDER MASK DETAILS

4214825/C 02/2019

NOTES: (continued)

- 6. Publication IPC-7351 may have alternate designs.
- 7. Solder mask tolerances between and around signal pads can vary based on board fabrication site.

# EXAMPLE STENCIL DESIGN

D0008A

SOIC - 1.75 mm max height

SMALL OUTLINE INTEGRATED CIRCUIT



SOLDER PASTE EXAMPLE  
BASED ON .005 INCH [0.125 MM] THICK STENCIL  
SCALE:8X

4214825/C 02/2019

NOTES: (continued)

8. Laser cutting apertures with trapezoidal walls and rounded corners may offer better paste release. IPC-7525 may have alternate design recommendations.
9. Board assembly site may have different recommendations for stencil design.

P (R-PDIP-T8)

PLASTIC DUAL-IN-LINE PACKAGE



- NOTES:
- A. All linear dimensions are in inches (millimeters).
  - B. This drawing is subject to change without notice.
  - C. Falls within JEDEC MS-001 variation BA.

N (R-PDIP-T\*\*)

PLASTIC DUAL-IN-LINE PACKAGE

16 PINS SHOWN



- NOTES:
- A. All linear dimensions are in inches (millimeters).
  - B. This drawing is subject to change without notice.
  - (C) Falls within JEDEC MS-001, except 18 and 20 pin minimum body length (Dim A).
  - (D) The 20 pin end lead shoulder width is a vendor option, either half or full width.

DBV0006A



# PACKAGE OUTLINE

SOT-23 - 1.45 mm max height

SMALL OUTLINE TRANSISTOR

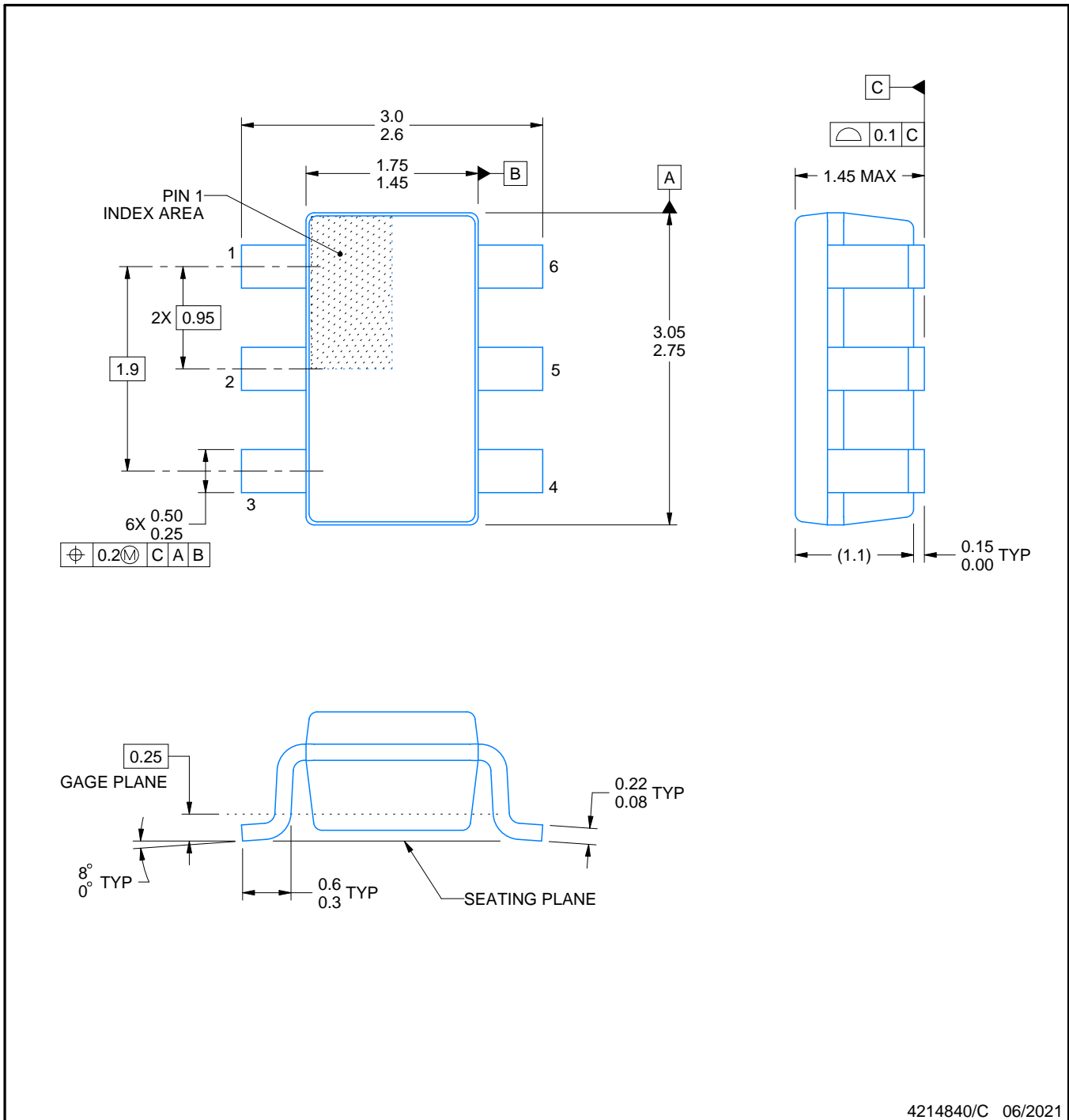

4214840/C 06/2021

## NOTES:

1. All linear dimensions are in millimeters. Any dimensions in parenthesis are for reference only. Dimensioning and tolerancing per ASME Y14.5M.
2. This drawing is subject to change without notice.
3. Body dimensions do not include mold flash or protrusion. Mold flash and protrusion shall not exceed 0.25 per side.
4. Leads 1,2,3 may be wider than leads 4,5,6 for package orientation.
5. Reference JEDEC MO-178.



# EXAMPLE BOARD LAYOUT

DBV0006A

SOT-23 - 1.45 mm max height

SMALL OUTLINE TRANSISTOR

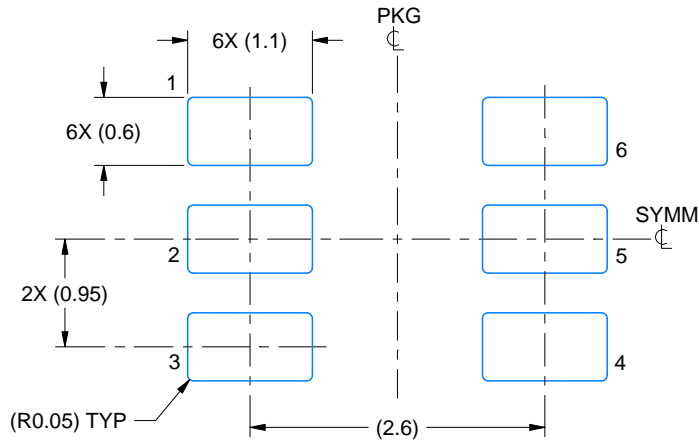

LAND PATTERN EXAMPLE  
EXPOSED METAL SHOWN  
SCALE:15X

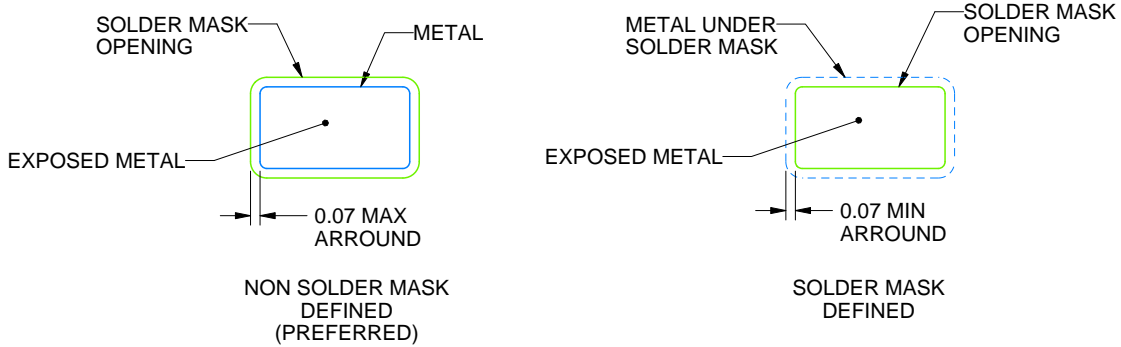

SOLDER MASK DETAILS

4214840/C 06/2021

NOTES: (continued)

- 6. Publication IPC-7351 may have alternate designs.
- 7. Solder mask tolerances between and around signal pads can vary based on board fabrication site.

# EXAMPLE STENCIL DESIGN

DBV0006A

SOT-23 - 1.45 mm max height

SMALL OUTLINE TRANSISTOR

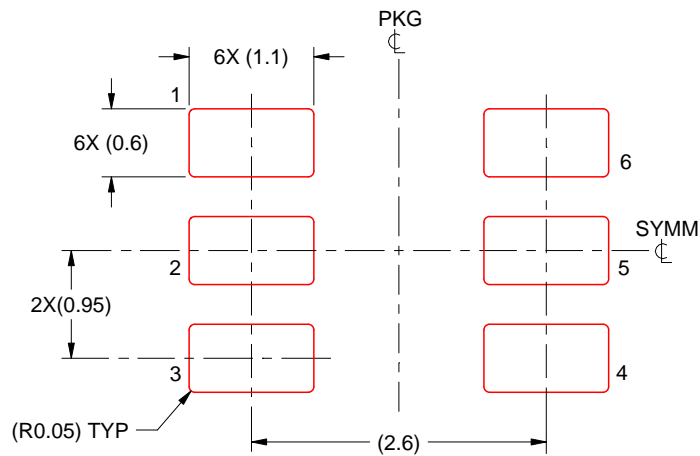

SOLDER PASTE EXAMPLE  
BASED ON 0.125 mm THICK STENCIL  
SCALE:15X

4214840/C 06/2021

NOTES: (continued)

8. Laser cutting apertures with trapezoidal walls and rounded corners may offer better paste release. IPC-7525 may have alternate design recommendations.
9. Board assembly site may have different recommendations for stencil design.

DGK (S-PDSO-G8)

PLASTIC SMALL-OUTLINE PACKAGE



- NOTES:
- A. All linear dimensions are in millimeters.
  - B. This drawing is subject to change without notice.
  - C. Body length does not include mold flash, protrusions, or gate burrs. Mold flash, protrusions, or gate burrs shall not exceed 0.15 per end.
  - D. Body width does not include interlead flash. Interlead flash shall not exceed 0.50 per side.
  - E. Falls within JEDEC MO-187 variation AA, except interlead flash.



- NOTES:
- All linear dimensions are in millimeters.
  - This drawing is subject to change without notice.
  - Publication IPC-7351 is recommended for alternate designs.
  - Laser cutting apertures with trapezoidal walls and also rounding corners will offer better paste release. Customers should contact their board assembly site for stencil design recommendations. Refer to IPC-7525 for other stencil recommendations.
  - Customers should contact their board fabrication site for solder mask tolerances between and around signal pads.

D (R-PDSO-G16)

PLASTIC SMALL OUTLINE



- NOTES:
- A. All linear dimensions are in inches (millimeters).
  - B. This drawing is subject to change without notice.
  - C. Body length does not include mold flash, protrusions, or gate burrs. Mold flash, protrusions, or gate burrs shall not exceed 0.006 (0,15) each side.
  - D. Body width does not include interlead flash. Interlead flash shall not exceed 0.017 (0,43) each side.
  - E. Reference JEDEC MS-012 variation AC.

D (R-PDSO-G16)

PLASTIC SMALL OUTLINE



- NOTES:
- A. All linear dimensions are in millimeters.
  - B. This drawing is subject to change without notice.
  - C. Publication IPC-7351 is recommended for alternate designs.
  - D. Laser cutting apertures with trapezoidal walls and also rounding corners will offer better paste release. Customers should contact their board assembly site for stencil design recommendations. Refer to IPC-7525 for other stencil recommendations.
  - E. Customers should contact their board fabrication site for solder mask tolerances between and around signal pads.



4220204/A 02/2017

NOTES:

1. All linear dimensions are in millimeters. Any dimensions in parenthesis are for reference only. Dimensioning and tolerancing per ASME Y14.5M.
2. This drawing is subject to change without notice.
3. This dimension does not include mold flash, protrusions, or gate burrs. Mold flash, protrusions, or gate burrs shall not exceed 0.15 mm per side.
4. This dimension does not include interlead flash. Interlead flash shall not exceed 0.25 mm per side.
5. Reference JEDEC registration MO-153.

# EXAMPLE BOARD LAYOUT

PW0016A

TSSOP - 1.2 mm max height

SMALL OUTLINE PACKAGE



LAND PATTERN EXAMPLE  
EXPOSED METAL SHOWN  
SCALE: 10X



SOLDER MASK DETAILS

4220204/A 02/2017

NOTES: (continued)

- 6. Publication IPC-7351 may have alternate designs.
- 7. Solder mask tolerances between and around signal pads can vary based on board fabrication site.



# EXAMPLE STENCIL DESIGN

PW0016A

TSSOP - 1.2 mm max height

SMALL OUTLINE PACKAGE

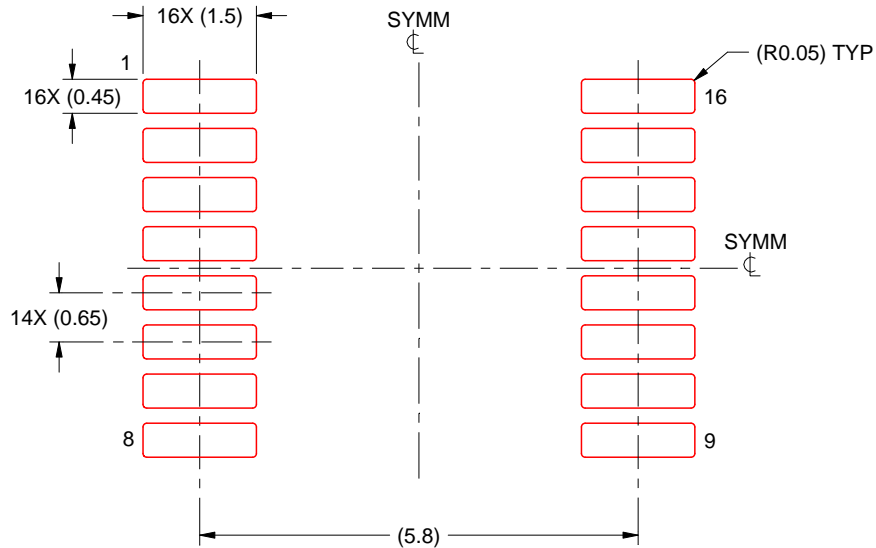

SOLDER PASTE EXAMPLE  
BASED ON 0.125 mm THICK STENCIL  
SCALE: 10X

4220204/A 02/2017

NOTES: (continued)

8. Laser cutting apertures with trapezoidal walls and rounded corners may offer better paste release. IPC-7525 may have alternate design recommendations.
9. Board assembly site may have different recommendations for stencil design.

## IMPORTANT NOTICE AND DISCLAIMER

TI PROVIDES TECHNICAL AND RELIABILITY DATA (INCLUDING DATASHEETS), DESIGN RESOURCES (INCLUDING REFERENCE DESIGNS), APPLICATION OR OTHER DESIGN ADVICE, WEB TOOLS, SAFETY INFORMATION, AND OTHER RESOURCES "AS IS" AND WITH ALL FAULTS, AND DISCLAIMS ALL WARRANTIES, EXPRESS AND IMPLIED, INCLUDING WITHOUT LIMITATION ANY IMPLIED WARRANTIES OF MERCHANTABILITY, FITNESS FOR A PARTICULAR PURPOSE OR NON-INFRINGEMENT OF THIRD PARTY INTELLECTUAL PROPERTY RIGHTS.

These resources are intended for skilled developers designing with TI products. You are solely responsible for (1) selecting the appropriate TI products for your application, (2) designing, validating and testing your application, and (3) ensuring your application meets applicable standards, and any other safety, security, or other requirements. These resources are subject to change without notice. TI grants you permission to use these resources only for development of an application that uses the TI products described in the resource. Other reproduction and display of these resources is prohibited. No license is granted to any other TI intellectual property right or to any third party intellectual property right. TI disclaims responsibility for, and you will fully indemnify TI and its representatives against, any claims, damages, costs, losses, and liabilities arising out of your use of these resources.

TI's products are provided subject to TI's Terms of Sale (<https://www.ti.com/legal/termsofsale.html>) or other applicable terms available either on [ti.com](https://www.ti.com) or provided in conjunction with such TI products. TI's provision of these resources does not expand or otherwise alter TI's applicable warranties or warranty disclaimers for TI products.

Mailing Address: Texas Instruments, Post Office Box 655303, Dallas, Texas 75265  
Copyright © 2021, Texas Instruments Incorporated