

max. 440 m³/h

DC axial fans

Series 4100 N High Performance 119 x 119 x 38 mm



Highlights:

- Very rigid compression curve for high air flow at high back pressure.
- Low operating noise level at high back pressure.
- Optional Vario-Pro: Highly adaptable software configuration of the fan enables a tailor-made solution to the specific requirements of your applications.

General characteristics:

- Material: aluminium housing, fibreglass-reinforced PA impeller; housing with grounding lug for screw M4 x 8 (Torx).
- Fully integrated electronic commutation.
- Protected against reverse polarity and locking.
- Connection via single strands AWG 22, UL1007, TR 64, bared and tin-plated
- Air intake over struts. Direction of rotation clockwise, seen on rotor.
- Mass: 390 g.

Nominal data	Air flow		Nominal voltage	Voltage range	Sound pressure level	Sound power level	Sinter sleeve bearings Ball bearings	Power input	Nominal speed	Temperature range	Service life L ₁₀ (40 °C) ebm-papst Standard	Service life L ₁₀ (τ _{max}) ebm-papst Standard	Life expectancy L ₁₀ Δ (40 °C) see P. 15	Curve	Specials
	m ³ /h	CFM													
4112 NHH	260	152,9	12	9...15	60	6,8	■	13,3	5 000	-20...+65	70 000 / 55 000	147 500	1		
4112 NH3	310	182,4	12	9...15	65	7,2	■	21,6	6 000	-20...+65	65 000 / 37 500	132 500	2	/2	
4112 NH4	355	208,9	12	9...14	67	7,4	■	32,0	6 800	-20...+65	62 500 / 35 000	125 000	3	/2	
4114 NHH	260	152,9	24	16...30	60	6,8	■	12,4	5 000	-20...+65	70 000 / 52 500	147 500	1	/2	
4114 NH3	310	182,4	24	16...30	65	7,2	■	19,5	6 000	-20...+65	65 000 / 37 500	132 500	2	/2	
4114 NH4	355	208,9	24	16...30	67	7,4	■	30,0	6 800	-20...+65	62 500 / 35 000	125 000	3	/2	
4114 NH5	390	229,5	24	16...30	70	7,6	■	45,0	7 500	-20...+65	62 500 / 35 000	125 000	4	/2	
4114 NH6	440	259,0	24	16...30	73	8,1	■	65,0	8 400	-20...+65	60 000 / 32 500	120 000	5	/2	
4118 NHH	260	152,9	48	36...60	60	6,8	■	12,0	5 000	-20...+65	70 000 / 52 500	147 500	1	/2	
4118 NH3	310	182,4	48	36...60	65	7,2	■	20,0	6 000	-20...+65	65 000 / 37 500	132 500	2	/2	
4118 NH4	355	208,9	48	36...60	67	7,4	■	28,0	6 800	-20...+65	62 500 / 35 000	125 000	3	/2	
4118 NH5	390	229,5	48	36...60	70	7,6	■	45,0	7 500	-20...+65	62 500 / 35 000	125 000	4	/2	
4118 NH6	440	259,0	48	36...60	73	8,1	■	62,0	8 400	-20...+65	60 000 / 32 500	120 000	5	/2	

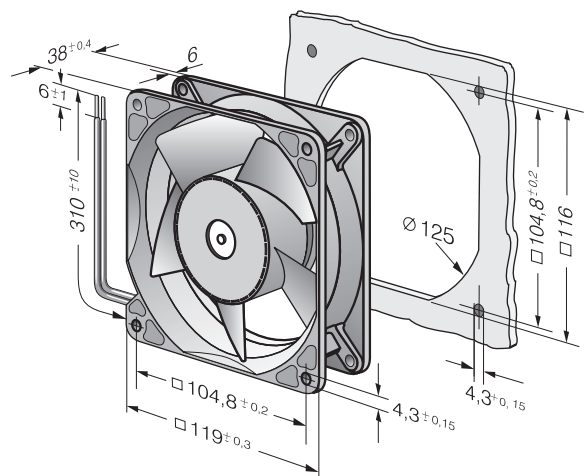
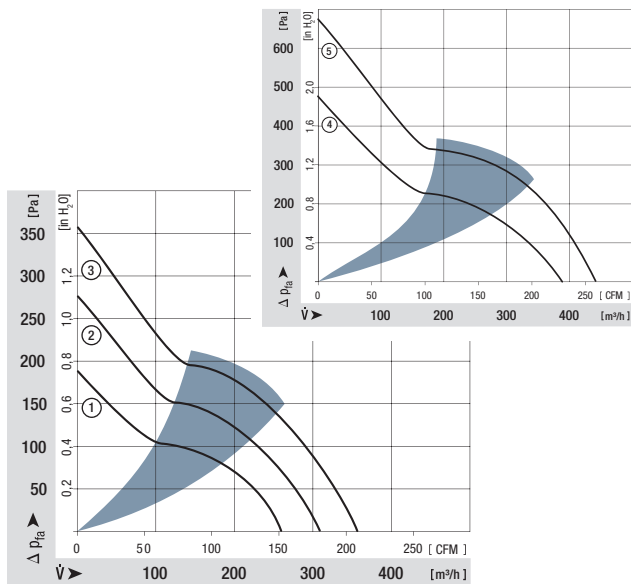

Speed signal /2

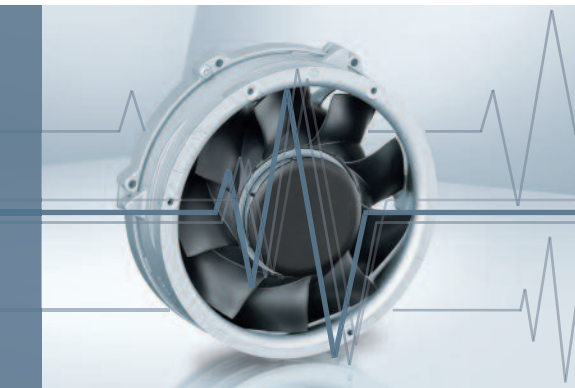

- Speed-proportional, square-wave signal for external monitoring of the fan motor speed
- 2, 3, or 6 pulses per revolution
- Open-collector signal output
- Extremely wide operating voltage range
- Easy adaptation to user interface
- Connection via separate cable
- The sensor signal also serves as a major comparison variable for setting and maintaining the setpoint speed for interactive or controlled cooling with one or more interconnected fans.

Electrical hookup

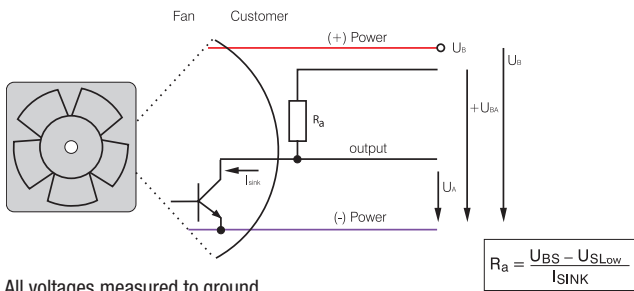

All voltages measured to ground.
External load resistor R_a / U_S / U_{BS} required.

Signal output voltage

Standard signal for all models (exceptions see below)

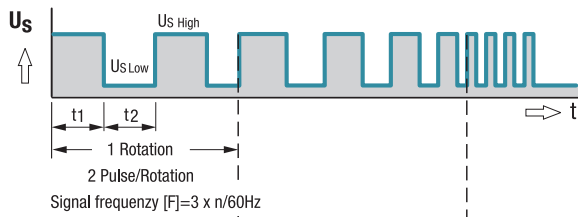

For multi options control input and 4100 NH7 and NH8

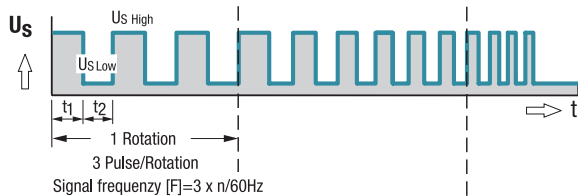

All TD Fans e.g. 6300 TD

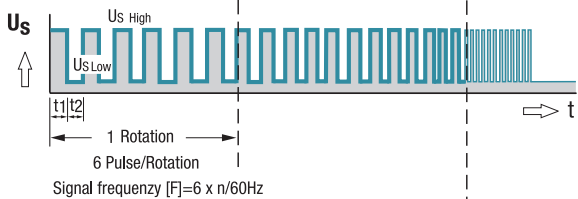

Fan speed

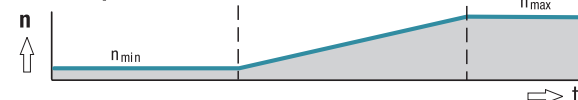

Signal data	Speed signal	Condition:	Speed signal	Condition:	Tach operating	Admissible sink current	Pulses per revolution	Fan description
	$U_{S\ Low}$	I_{SINK}	$U_{S\ High}$	I_{SOURCE}	voltage $U_{BS\ max.}$	$I_{SINK\ max.}$		Basic type
Type	VDC	mA	VDC	mA	VDC	mA	Page	
250	≤ 0.4	2	≤ 30	0	30	2	2	31
400 F	≤ 0.4	1	≤ 30	0	30	2	2	32
400	≤ 0.4	1	≤ 30	0	30	2	2	33
420 J	≤ 0.4	2	≤ 15	0	15	4	2	34
500 F	≤ 0.4	1	≤ 30	0	30	2	2	35
600 F	≤ 0.4	1	≤ 30	0	30	2	2	36
620	≤ 0.4	2	≤ 30	0	30	4	2	37
630 U	≤ 0.4	2	≤ 30	0	30	4	2	38
600 N	≤ 0.4	2	≤ 28	0	28	4	2	39
600 J	≤ 0.4	2	≤ 30	0	30	4	2	41
700 F	≤ 0.4	2	≤ 30	0	30	4	2	42
8450	≤ 0.4	2	≤ 28	0	28	4	2	43
8400 N	≤ 0.4	2	≤ 28	0	28	4	2	44
8400 N VARIOFAN	≤ 0.4	2	≤ 30	0	30	4	2	45
8300	≤ 0.4	2	≤ 30	0	30	4	2	46
8200 J	≤ 0.4	2	≤ 30	0	30	4	2	47
3400 N	≤ 0.4	2	≤ 28	0	28	4	2	48
3400 N VARIOFAN	≤ 0.4	2	≤ 30	0	30	4	2	49
3300 N	≤ 0.4	2	≤ 30	0	30	4	2	50
3212 J / 3214 J	≤ 0.4	2	≤ 30	0	30	4	2	51
3218 J	≤ 0.4	2	≤ 60	0	60	4	2	51
3250 J	≤ 0.4	2	≤ 60	0	60	4	3	52
4412 F / 4414 F	≤ 0.4	2	≤ 30	0	30	4	2	53
4418 F	≤ 0.4	2	≤ 60	0	60	4	2	53
4400 FN	≤ 0.4	2	≤ 30	0	30	4	2	55
4312 / 4314	≤ 0.4	2	≤ 30	0	30	4	2	56
4318	≤ 0.4	2	≤ 60	0	60	4	2	56
4312 / 4314 VARIOFAN	≤ 0.4	2	≤ 30	0	30	4	2	57
4318 VARIOFAN	≤ 0.4	2	≤ 60	0	60	4	2	57
4400	≤ 0.4	2	≤ 30	0	30	4	2	58/59
4100 N	≤ 0.4	2	≤ 30	0	30	4	2	60
4100 NHH...NH6	≤ 0.4	2	≤ 60	0	60	10	2	61
4100 NH7...NH8	≤ 0.4	2	≤ 60	0	60	20	3	62
DV 4100	≤ 0.4	2	≤ 30	0	30	4	2	63
5200 N	≤ 0.4	2	≤ 30	0	30	4	2	64
DV 5200	≤ 0.4	2	≤ 30	0	30	4	2	65

Subject to change

Available on request:

- Electrically isolated speed signal circuit
- Varying voltage potentials for power and logic circuit

Signal data		Speed signal $U_{S, Low}$	Condition: I_{sink}	Speed signal $U_{S, High}$	Condition: I_{source}	Tach operating voltage $U_{BS, max.}$	Admissible sink current $I_{sink, max.}$	Pulses per revolution	Fan description Basic type
Type	VDC	mA	VDC	mA	VDC	mA	Page		
5112 N	≤ 0.4	2	≤ 15	0	5	20	2	66	
5114 N / 5118 N	≤ 0.4	2	≤ 60	0	60	20	2	66	
5300	≤ 0.4	2	≤ 60	0	60	4	2	67	
5300 TD	≤ 0.4	2	≤ 60	0	60	20	6	68	
7112 N / 7118 N	≤ 0.4	2	≤ 60	0	60	20	2	69	
7114 N	≤ 0.4	2	≤ 30	0	30	20	2	69	
7200 N	≤ 0.4	2	≤ 15	0	15	20	2	70	
6400	≤ 0.4	2	≤ 60	0	60	20	2	71	
6300 TD	≤ 0.4	2	≤ 60	0	60	20	6	75	
6300 N	≤ 0.4	2	≤ 60	0	60	20	6	76	
6300 NTD	≤ 0.4	2	≤ 60	0	60	20	6	77	
6300	≤ 0.4	2	≤ 60	0	60	20	2	78	
DV 6300 TD	≤ 0.4	2	≤ 60	0	60	20	6	80	
2200 FTD	≤ 0.4	2	≤ 60	0	60	20	6	81	
RL 48	≤ 0.4	2	≤ 30	0	30	4	2	97	
RL 65	≤ 0.4	2	≤ 30	0	30	4	2	98	
RL 90 N	≤ 0.4	2	≤ 30	0	30	4	2	99	
RLF 100	≤ 0.4	2	≤ 30	0	30	4	2	100	
RG 90 N	≤ 0.4	2	≤ 30	0	30	4	2	101	
RG 125 N	≤ 0.4	2	≤ 30	0	30	4	2	102	
RG 140 N	≤ 0.4	3	≤ 60	0	60	4	2	103	
RG 160 N	≤ 0.4	2	≤ 30	0	30	20	2	104	
RG 160 NTD	≤ 0.4	2	≤ 60	0	60	20	6	105	
RG 190 TD	≤ 0.4	2	≤ 60	0	60	20	6	106	
RG 220 TD	≤ 0.4	2	≤ 60	0	60	20	6	107	
RG 225 TD	≤ 0.4	2	≤ 60	0	60	20	6	108	
RET 97 TD	≤ 0.4	2	≤ 60	0	60	20	6	109	
REF 100	≤ 0.4	2	≤ 30	0	30	4	2	110	
RER 120 TD	≤ 0.4	2	≤ 60	0	60	20	6	112	
RER 133 TD	≤ 0.4	2	≤ 60	0	60	20	6	117	
RER 160 NTD	≤ 0.4	2	≤ 60	0	60	20	6	119	
REF 175 TD	≤ 0.4	2	≤ 60	0	60	20	6	120	
RER 175 TD	≤ 0.4	2	≤ 60	0	60	20	6	121	
RER 190 TD	≤ 0.4	2	≤ 60	0	60	20	6	122	
RER 220 TD	≤ 0.4	2	≤ 60	0	60	20	6	128	
RER 225 TD	≤ 0.4	2	≤ 60	0	60	20	6	129	

Subject to change

Note:

Fans that come with these fan specials could have variations with respect to the temperature range, voltage range, and power consumption compared to standard fans without specials.

Mouser Electronics

Authorized Distributor

Click to View Pricing, Inventory, Delivery & Lifecycle Information:

[ebm-papst:](#)

[4118N/2H3](#)