

**80mΩ ,Adjustable Fast Response Current-Limited Power-Distribution Switch**
**FEATURES**

- Compliant to USB Specifications
- Integrated 80mΩ Power MOSFET
- Low Supply Current  
15μA Typical at Switch On State  
1μA Typical at Switch Off State
- Wide Input Voltage Range:2.4V to 5.5V
- Fast Transient Response: <math><2\mu\text{s}</math>
- Reverse Current Flow Blocking
- Thermal Shutdown Protection
- Hot Plug-In Application (Soft-Start)
- Available in a 5-Pin SOT23-5 Package

**APPLICATIONS**

- USB Bus/Self Powered Hubs
- USB Peripherals
- Notebook Computers
- Battery-Charger Circuits
- Personal Communication Devices

**GENERAL DESCRIPTION**

The SD00HA is a cost-effective, low voltage, single P-MOSFET load switch, optimized for self-powered and bus-powered Universal Serial Bus (USB) applications. This switch operates with inputs ranging from 2.4V to 5.5V, making it ideal for both 3V and 5V systems. The switch's low  $R_{DS(ON)}$ , 80mΩ, meets USB voltage drop requirements. The SD00HA is also protected from thermal overload which limits power dissipation and junction temperatures. Current limit threshold is programmed with a resistor from SET to ground. The quiescent supply current is typically 15μA at switch on state. At switch off state the supply current decreases to less than 1μA. The SD00HA is available in SOT23-5 package.

**TYPICAL APPLICATION**

Figure 1. Basic Application Circuit



**ABSOLUTE MAXIMUM RATINGS** (Note 1)

Input Supply Voltage.....	-0.3V to 7V	Junction Temperature(Note2).....	150°C
EN Voltages.....	-0.3V to ( $V_{IN} + 0.3V$ )	Operating Temperature Range.....	-40°C to 85°C
SET Voltage.....	-0.3V to ( $V_{IN} + 0.3V$ )	Lead Temperature(Soldering,10s).....	300°C
Power Dissipation.....	0.4W	Storage Temperature Range.....	-65°C to 150°C
Thermal Resistance $\theta_{JC}$ .....	130°C/W	ESD HBM(Human Body Mode).....	2kV
Thermal Resistance $\theta_{JA}$ .....	250°C/W	ESD MM(Machine Mode).....	200V

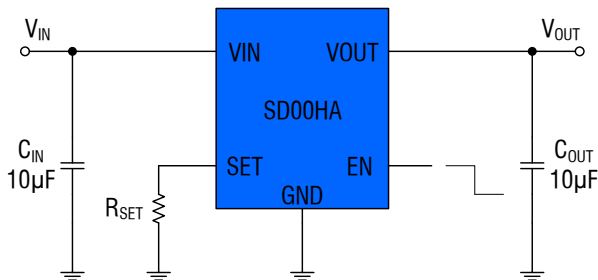
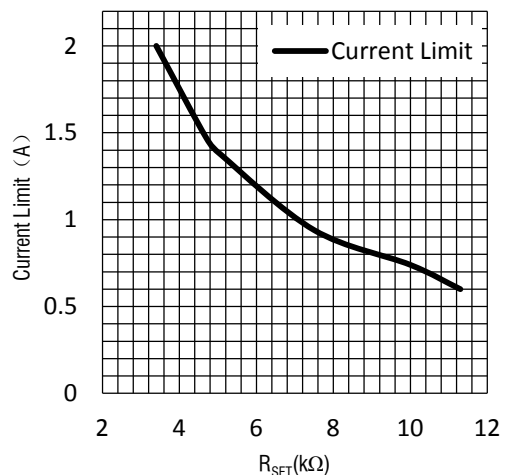
**PACKAGE/ORDER INFORMATION**

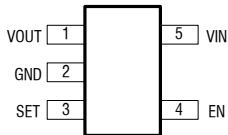
	Order Part Number	Package	Top Marking
<p style="text-align: center;">TOP VIEW</p>  <p style="text-align: center;">5-LEAD PLASTIC SOT-23  <math>T_{JMAX} = 150^{\circ}C</math>, <math>\theta_{JA} = 250^{\circ}C/W</math>, <math>\theta_{JC} = 130^{\circ}C/W</math></p>	SD00HA	SOT23-5	D00HAW

**PIN DESCRIPTION**

Pin Name	Pin Number	Description
VOUT	1	Power-switch output
GND	2	Ground connection; connect externally to Power PAD
SET	3	External resistor used to set current-limit threshold
EN	4	Enable input, logic high turns on power switch
VIN	5	Input voltage; connect a 10uF or greater ceramic capacitor from VIN to GND as close to the IC as possible

**ELECTRICAL CHARACTERISTICS** (Note 3)

 ( $V_{IN}=5V$ ,  $T_A = -40^{\circ}C$  to  $85^{\circ}C$ , unless otherwise noted.)

PARAMETER		SYMBOL	CONDITIONS	MIN	TYP	MAX	UNIT
Input Voltage Range		$V_{IN}$		2.4		5.5	V
Switch On Resistance		$R_{DS(ON)}$	$V_{IN}=5V$		80	100	m $\Omega$
			$V_{IN}=3V$		90	110	m $\Omega$
Operation Quiescent Current		$I_Q$	$V_{IN}=5V, EN=Active,$ No load		15	25	$\mu A$
Off Supply Current		$I_{Q(OFF)}$	$V_{IN}=5.5V, EN=Inactive$			1	$\mu A$
Off Switch Current		$I_{Q(SW OFF)}$	$V_{IN}=5.5V, EN=Inactive$			1	$\mu A$
Under-voltage Lockout		$V_{UVLO}$	$V_{IN}$ Increasing		1.8	2.4	V
Under-voltage Lockout Hysteresis		$\Delta V_{UVLO}$	$V_{IN}$ decreasing		0.1		V
Current Limit Threshold		$I_{LIM}$	$R_{SET}=6.8k\Omega$		1		A
EN Threshold	Logic-Low Voltage	$V_{IL}$	$V_{IN}=2.5V$ to $5.5V$			0.8	V
	Logic-High Voltage	$V_{IH}$	$V_{IN}=2.5V$ to $5.5V$	2			V
Output Leakage Current		$I_{LEAK}$	$EN=Inactive,$ $R_{LOAD}=0\Omega$		0.5	10	$\mu A$
Current Limit Response Time		$T_{RESP}$	$V_{IN}=5V$		1		$\mu s$
Thermal Shutdown Protection		$T_{SD}$			150		$^{\circ}C$
Thermal Shutdown Hysteresis		$\Delta T_{SD}$			20		$^{\circ}C$

**Note 1:** Absolute Maximum Ratings are those values beyond which the life of a device may be impaired.

**Note 2:**  $T_J$  is calculated from the ambient temperature  $T_A$  and power dissipation  $P_D$  according to the following formula:  $T_J = T_A + (P_D) \times (250^{\circ}C/W)$ .

**Note 3:** 100% production test at  $25^{\circ}C$ . Specifications over the temperature range are guaranteed by design and characterization.

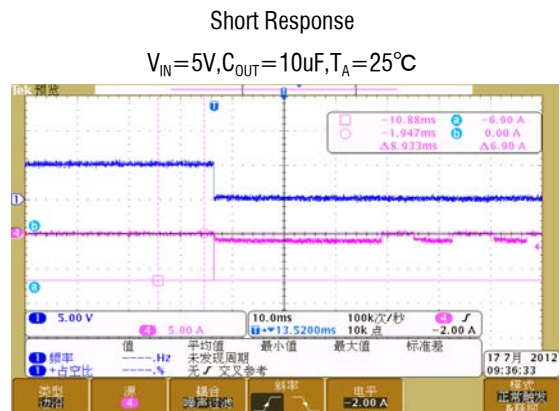
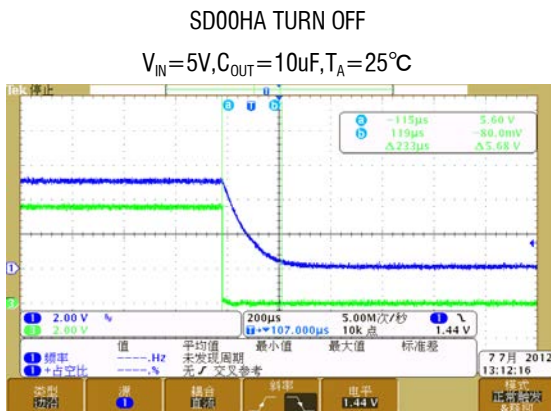
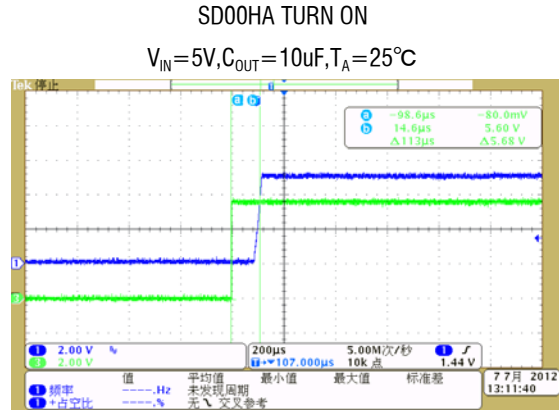
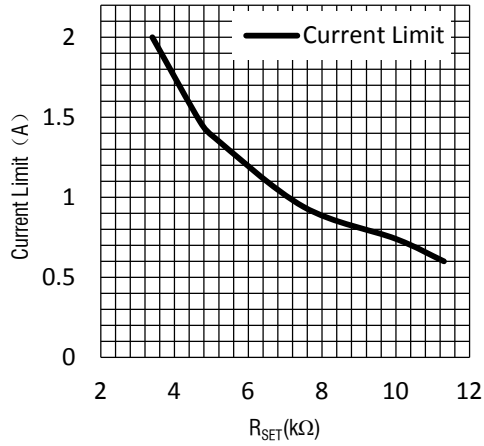
**TYPICAL PERFORMANCE CHARACTERISTICS**

**FUNCTIONAL BLOCK DIAGRAM**

Figure 2. SD00HA Block Diagram

**APPLICATIONS INFORMATION**

The SD00HA is a single channel current limiting load switch that is intended to protect against short circuit and over current events by current limiting to a preset level. This device is optimized for self-powered and bus-powered Universal Serial Bus (USB) applications. The switch's low  $R_{DS(ON)}$ , 80m $\Omega$ , meets USB voltage drop requirements; and a flag output is available to indicate fault conditions to the local USB controller.

**Input and Output**

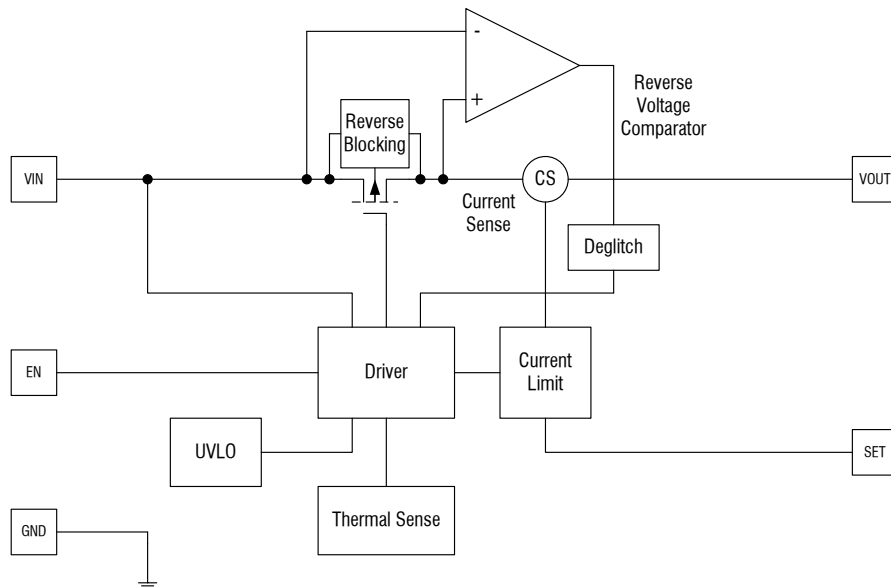
$V_{IN}$  (input) is the power source connection to the internal circuitry and the source of the MOSFET.  $V_{OUT}$  (output) is the drain of the MOSFET. In a typical application, current flows through the switch from  $V_{IN}$  to  $V_{OUT}$  toward the load. If  $V_{OUT}$  is greater than  $V_{IN}$ , current will flow from  $V_{OUT}$  to  $V_{IN}$  since the MOSFET is bidirectional when on. The SD00HA's reverse current blocking feature

prevents current to flow from  $V_{OUT}$  to  $V_{IN}$  when the device is disabled.

**Soft Start for Hot Plug-In Applications**

In order to eliminate the upstream voltage droop caused by the large inrush current during hot-plug events, the "soft-start" feature effectively isolates the power source from extremely large capacitive loads, satisfying the USB voltage droop requirements.

**Input capacitor**

The input capacitor  $C_{IN}$  protects the power supply from current transients generated by the load attached to the SD00HA. When a short circuit is suddenly applied to the output of the SD00HA, a large current, limited only by the  $R_{DS(ON)}$  of the MOSFET, will flow for less than 2 $\mu$ s before the current limit circuitry activates. In this event, a moderately sized  $C_{IN}$  will dramatically reduce the voltage transient seen by the power

supply and by other circuitry upstream from the SD00HA. The extremely fast short-circuit response time of the SD00HA reduces the size requirement for  $C_{IN}$ .  $C_{IN}$  should be located as close to the device  $V_{IN}$  pin as practically possible. Ceramic, tantalum, or aluminum electrolytic capacitors are appropriate for  $C_{IN}$ . There is no specific capacitor ESR requirement for  $C_{IN}$ . However, for higher current operation, ceramic capacitors are recommended for  $C_{IN}$  due to their inherent capability over tantalum capacitors to withstand input current surges from low impedance sources such as batteries in portable devices.

### Output capacitor

A low-ESR 150 $\mu$ F aluminum electrolytic or tantalum between  $V_{OUT}$  and GND is strongly recommended to meet the 330mV maximum droop requirement in the hub  $V_{BUS}$  (Per USB 2.0, output ports must have a minimum 120 $\mu$ F of low-ESR bulk capacitance per hub). Standard bypass methods should be used to minimize inductance and resistance between the bypass capacitor and the downstream connector to reduce EMI and decouple voltage droop caused when downstream cables are hot-insertion transients. Ferrite beads in series with  $V_{BUS}$ , the ground line and the 0.1 $\mu$ F bypass capacitors at the power connector pins are recommended for EMI and ESD protection. The bypass capacitor itself should have a low dissipation factor to allow decoupling at higher frequencies.

### Thermal Considerations

Since the SD00HA has internal current limit and over temperature protection, junction temperature is rarely a concern. However, if the application requires large currents in a hot environment, it is possible that temperature, rather than current limit, will be the dominant regulating condition. In these applications, the maximum current available without risk of an over-temperature condition must be calculated. Power dissipation can be

calculated based on the output current and the  $R_{DS(ON)}$  of switch as below.

$$P_D = R_{DS(ON)} \times I_{OUT}^2$$

Although the devices are rated for 2A(max) of output current, but the application may limit the amount of output current based on the total power dissipation and the ambient temperature. The final operating junction temperature for any set of conditions can be estimated by the following thermal equation :

$$P_{D(MAX)} = \frac{T_{J(MAX)} - T_A}{\theta_{JA}}$$

Where  $T_{J(MAX)}$  is the maximum operation junction temperature 150 $^{\circ}$ C,  $T_A$  is the ambient temperature and the  $\theta_{JA}$  is the junction to ambient thermal resistance. The junction to ambient thermal resistance  $\theta_{JA}$  is layout dependent. For SOT23-5 and TSOT23-5 packages, the thermal resistance  $\theta_{JA}$  is 250 $^{\circ}$ C/W. The maximum power dissipation at  $T_A = 25^{\circ}$ C is 0.4W for SOT23-5 and TSOT23-5 Package.

### Current limit threshold Setting

Current limit threshold is programmed with a resistor from SET to ground marked as  $R_{SET}$ . It can be estimated by the following equation:

$$I_{SET} (A) = \frac{6.8k\Omega}{R_{SET} (k\Omega)}$$

Such as the following table.

$I_{SET}$ (mA)	$R_{SET}$ (k $\Omega$ )
600	11.3
800	8.45
1000	6.8
1500	4.53
2000	3.4

## PCB Layout Recommendations

When laying out the printed circuit board, the following checking should be used to ensure proper operation of the SD00HA. Check the following in your layout:

- Does the (+) plates of  $C_{IN}$  connect to  $V_{IN}$  as closely as possible. This capacitor provides the AC current to the internal power MOSFETs.
- Keep the (-) plates of  $C_{IN}$  and  $C_{OUT}$  as close as possible

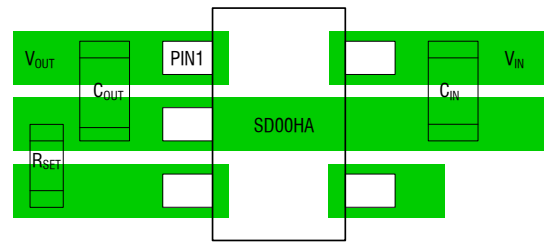
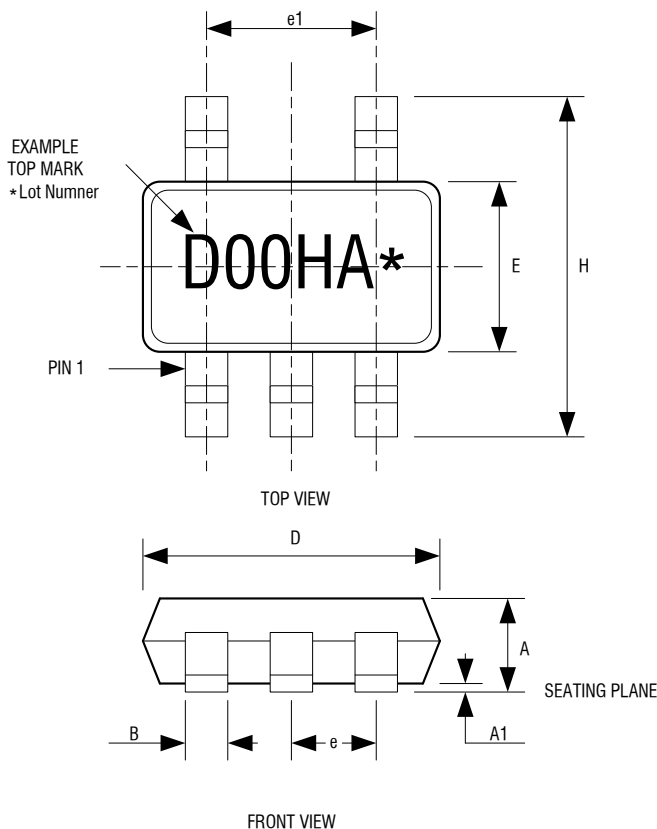

Figure 3. SD00HA Suggested Layout

## PACKAGE DESCRIPTION

SOT23-5



### 5LD SOT-23 PACKAGE OUTLINE DIMENSIONS

Dimension	Min.	Max.
A	1.05	1.35
A1	0.04	0.15
B	0.3	0.5
C	0.09	0.2
D	2.8	3.0
H	2.5	3.1
E	1.5	1.7
e	0.95 REF.	
e1	1.90 REF.	
L1	0.2	0.55
L	0.35	0.8
Q	0°	10°

- NOTE:
1. DIMENSIONS ARE IN MILLIMETERS
  2. DRAWING NOT TO SCALE
  3. DIMENSIONS ARE INCLUSIVE OF PLATING
  4. DIMENSIONS ARE EXCLUSIVE OF MOLD FLASH AND METAL BURR