

FEATURES

- Step-down Switching Regulator
- Adjustable Version Output Voltage Range, 1.23V to 52V
± 4% Max over Line and Load conditions
- Guaranteed Output Current of 1A
- Fixed Output Voltages : 3.3V, 5.0V, 12V and 15V
- Wide Input Voltage Range 60V
- 52KHz Fixed Frequency Oscillator
- TTL Shutdown Capability, Low Power Standby Mode
- Requires only 4 External Components
- High Efficiency
- Use Readily Available Standard Inductors
- Available in TO-220, TO-263 and SOP-8PP Packages
- Thermal Shutdown and Current Limit Protection
- Moisture Sensitivity Level 3

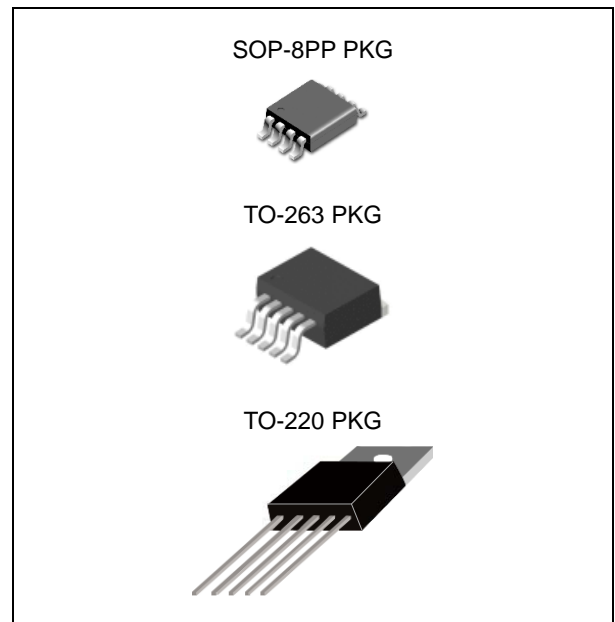

APPLICATIONS

- Simple high-efficiency step-down (buck) regulator
- Efficient pre-regulator for linear regulators
- On-card switching regulators
- Positive to negative converter (Buck-Boost)

ORDERING INFORMATION

Device	Package
LM2575HVDP-ADJ	SOP-8PP 8L
LM2575HVDP-X.X	
LM2575HVR-ADJ	TO-263 5L
LM2575HVR-X.X	
LM2575HVT-ADJ	TO-220 5L
LM2575HVT-X.X	

X.X = Output Voltage = 3.3, 5.0, 12, 15

DESCRIPTION

The LM2575HV series of regulators are monolithic integrated circuits that provide all the active functions for a step-down (buck) switching regulator, capable of driving 1A load with excellent line and load regulation. These devices are available in fixed output voltages of 3.3V, 5.0V, 12V, 15V and adjustable output versions.

Requiring a minimum number of external components, these regulators are simple to use and include internal frequency compensation and a fixed-frequency oscillator. The LM2575HV series offers a high-efficiency replacement for popular three-terminal linear regulators. It substantially reduces the size of the heat sink, and in some cases no heat sink is required. A standard series of inductors optimized for use with the LM2575HV are available from several different manufacturers. This feature greatly simplifies the design of switch-mode power supplies. Other features include a guaranteed ± 4% tolerance on output voltage within specified input voltages and output load conditions, and ± 10% on the oscillator frequency. External shutdown is included, featuring 50uA (typical) standby current. The output switch includes cycle-by-cycle current limiting, as well as thermal shutdown for full protection under fault conditions.

ABSOLUTE MAXIMUM RATINGS ^(Note 1)

CHARACTERISTIC	SYMBOL	MIN.	MAX.	UNIT
Input Supply Voltage	V_{IN}	-	63	V
ON/OFF Pin Input Voltage	$V_{ON/OFF}$	-0.3	+ V_{IN}	V
Output Voltage to Ground (Steady State)	V_{OUT}	-0.75	-	V
Lead Temperature (Soldering, 5 sec)	T_{SOL}	-	260	°C
Storage Temperature Range	T_{STG}	-65	150	°C
Maximum Junction Temperature Range	T_{JOPR}	-	150	°C

1A, 52KHz, Step-down Switching Regulator

LM2575HV

OPERATING RATINGS

CHARACTERISTIC	SYMBOL	MIN.	MAX.	UNIT
Supply Voltage	V_{IN}	-	60	V
Temperature Range	T_J	-40	125	°C

ORDERING INFORMATION

V_{OUT}	Package	Order No.	Description	Supplied As	Status
ADJ	SOP-8PP 8L	LM2575HVDP -ADJ	1A, 52kHz, Adjustable	Reel	Contact us
	TO-263 5L	LM2575HVR -ADJ	1A, 52kHz, Adjustable	Reel	Active
	TO-220 5L	LM2575HVT -ADJ	1A, 52kHz, Adjustable	Tube	Active
3.3V	SOP-8PP 8L	LM2575HVDP -3.3	1A, 52kHz, Fixed	Reel	Contact us
	TO-263 5L	LM2575HVR -3.3	1A, 52kHz, Fixed	Reel	Contact us
	TO-220 5L	LM2575HVT -3.3	1A, 52kHz, Fixed	Tube	Active
5.0V	SOP-8PP 8L	LM2575HVDP -5.0	1A, 52kHz, Fixed	Reel	Contact us
	TO-263 5L	LM2575HVR -5.0	1A, 52kHz, Fixed	Reel	Active
	TO-220 5L	LM2575HVT -5.0	1A, 52kHz, Fixed	Tube	Active
12V	SOP-8PP 8L	LM2575HVDP -12	1A, 52kHz, Fixed	Reel	Contact us
	TO-263 5L	LM2575HVR -12	1A, 52kHz, Fixed	Reel	Active
	TO-220 5L	LM2575HVT -12	1A, 52kHz, Fixed	Tube	Active
15V	SOP-8PP 8L	LM2575HVDP -15	1A, 52kHz, Fixed	Reel	Contact us
	TO-263 5L	LM2575HVR -15	1A, 52kHz, Fixed	Reel	Contact us
	TO-220 5L	LM2575HVT -15	1A, 52kHz, Fixed	Tube	Contact us

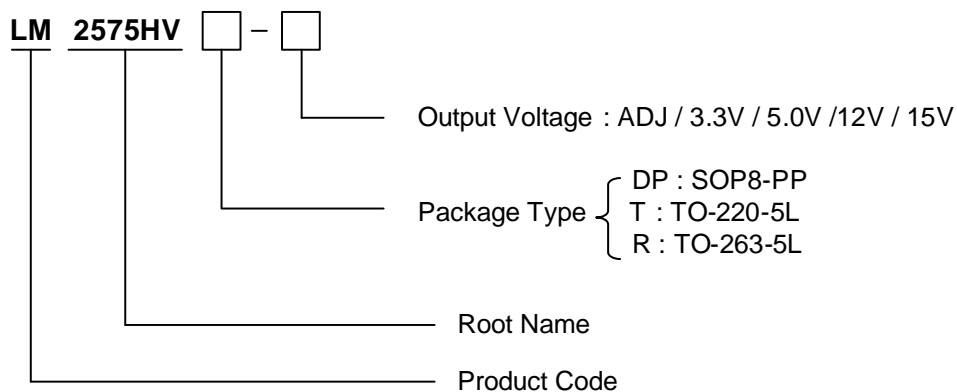

PIN CONFIGURATION

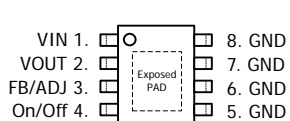

SOP-8PP

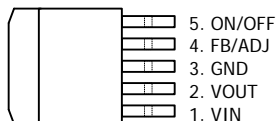

TO-263

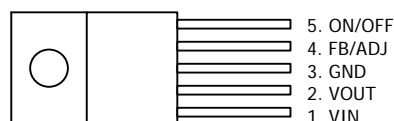

TO-220

PIN DESCRIPTION

Pin No.	TO-263 / TO-220 5 LEAD		SOP-8PP 8 LEAD	
	Name	Function	Name	Function
1	VIN	Input Supply	VIN	Input Supply
2	VOUT	Output Voltage	VOUT	Output Voltage
3	GND	Ground	FB / ADJ	Output Voltage Feedback or Output Adjust
4	FB / ADJ	Output Voltage Feedback or Output Adjust	ON/OFF	ON/OFF Shutdown
5	ON/OFF	ON/OFF Shutdown	GND	Ground
6	-	-	GND	Ground
7	-	-	GND	Ground
8	-	-	GND	Ground

* Exposed Pad of SOP8-PP package should be externally connected to GND.

ELECTRICAL CHARACTERISTICS

Specifications with standard type face are for $T_J=25^\circ\text{C}$ and those with boldface type apply over full operating temperature range. Unless otherwise specified, $V_{IN}=12\text{V}$ for the 3.3V, 5V, and Adjustable version, $V_{IN}=25\text{V}$ for the 12V version, and $V_{IN}=30\text{V}$ for the 15V version, $I_{LOAD}=0.5\text{A}$.

PARAMETER	SYMBOL	TEST CONDITION ^(Note 2)	MIN.	TYP.	MAX.	UNIT			
SYSTEM PARAMETERS ^(Note 3)									
Feedback Voltage	V_{FB}	LM2575HV-ADJ	$V_{IN}=12\text{V}, I_{LOAD}=0.5\text{A}$	1.217	1.230	1.243	V		
			$0.5\text{A} \leq I_{LOAD} \leq 1\text{A},$ $8\text{V} \leq V_{IN} \leq 55\text{V}$	1.193 1.180	1.230	1.273 1.286	V		
Output Voltage	V_O	LM2575HV-3.3	$V_{IN}=12\text{V}, I_{LOAD}=0.5\text{A}$	3.234	3.300	3.366	V		
			$0.5\text{A} \leq I_{LOAD} \leq 1\text{A},$ $6\text{V} \leq V_{IN} \leq 55\text{V}$	3.168 3.135	3.300	3.450 3.482	V		
		LM2575HV-5.0	$V_{IN}=12\text{V}, I_{LOAD}=0.5\text{A}$	4.900	5.000	5.100	V		
			$0.5\text{A} \leq I_{LOAD} \leq 1\text{A},$ $8\text{V} \leq V_{IN} \leq 55\text{V}$	4.800 4.750	5.000	5.225 5.275	V		
		LM2575HV-12	$V_{IN}=25\text{V}, I_{LOAD}=0.5\text{A}$	11.76	12.00	12.24	V		
			$0.5\text{A} \leq I_{LOAD} \leq 1\text{A},$ $15\text{V} \leq V_{IN} \leq 55\text{V}$	11.52 11.40	12.00	12.54 12.66	V		
		LM2575HV-15	$V_{IN}=25\text{V}, I_{LOAD}=0.5\text{A}$	14.70	15.00	15.30	V		
			$0.5\text{A} \leq I_{LOAD} \leq 1\text{A},$ $18\text{V} \leq V_{IN} \leq 55\text{V}$	14.40 14.25	15.00	15.68 15.83	V		
		Efficiency	η	LM2575HV-ADJ	$V_{IN}=12\text{V}, I_{LOAD}=1\text{A},$ $V_O=5\text{V}$		77		%
				LM2575HV-3.3	$V_{IN}=12\text{V}, I_{LOAD}=1\text{A}$		75		%
LM2575HV-5.0	$V_{IN}=12\text{V}, I_{LOAD}=1\text{A}$				77		%		
LM2575HV-12	$V_{IN}=15\text{V}, I_{LOAD}=1\text{A}$				88		%		
LM2575HV-15	$V_{IN}=18\text{V}, I_{LOAD}=1\text{A}$				88		%		
DEVICE PARAMETERS									
Feedback Bias Current	I_b	$V_O=5\text{V}$ (Adjustable Version Only)		50	100 500	nA			
Oscillator Frequency	f_O	(Note 8)	47 42	52	58 63	KHZ			
Saturation Voltage	V_{SAT}	$I_O=1\text{A}$ (Note 4)		1.4	1.55 1.70	V			
Max Duty Cycle(ON)	DC	(Note 5)	93	98		%			
Current Limit	I_{CL}	(Note 4, 8)	4.2 3.5	5.8	6.9 7.5	A			

(Continued)

PARAMETER	SYMBOL	TEST CONDITION		MIN.	TYP.	MAX.	UNIT
Output Leakage Current	I_L	(Notes 6, 7) Output=0V			7.5		mA
Quiescent Current	I_Q	(Note 6)			5	10	mA
Standby Quiescent Current	I_{STBY}	ON/OFF Pin=5V (OFF)	$V_{IN}=60V$		50	200	uA
$\overline{ON/OFF}$ CONTROL							
$\overline{ON/OFF}$ Pin Logic Input Level	V_{IH}	$V_O=0V$		2.2 2.4	1.4		V
	V_{IL}	$V_O=Nominal$ Output Voltage			1.2	1.0 0.8	V
$\overline{ON/OFF}$ Pin Input Current	I_{IH}	$\overline{ON/OFF}$ Pin=5V (OFF)			12	30	uA
	I_{IL}	$\overline{ON/OFF}$ Pin=0V (ON)			0	10	uA

Note 1. Absolute Maximum Ratings indicate limits beyond which damage to the device may occur. Operating Ratings indicate conditions for which the device is intended to be functional, but do not guarantee specific performance limits. For guaranteed specifications and test conditions, see the Electrical Characteristics.

Note 2. All limits guaranteed at room temperature (standard type face) and at temperature extremes (bold type face).

Note 3. External components such as the catch diode, inductor, input and output capacitors can affect switching regulator system performance. When the 2575HV is used as shown in the Figure 2 test circuit, system performance will be as shown in system parameters section of Electrical Characteristics.

Note 4. Output pin sourcing current. No diode, inductor or capacitor connected to output.

Note 5. Feedback pin removed from output and connected to 0V.

Note 6. Feedback pin removed from output and connected to +12V for the Adjustable, 3.3V, and 5V, versions, and +25V for the 12V and 15V versions, to force the output transistor OFF.

Note 7. $V_{IN}=60V$.

Note 8. The oscillator frequency reduces to approximately 11 kHz in the event of an output short or an overload which causes the regulated output voltage to drop approximately 40% from the nominal output voltage. This self protections feature lowers the average power dissipation of the IC by lowering the minimum duty cycle from 5% down to approximately 2%.

TYPICAL OPERATING CHARACTERISTIC

Normalized Output Voltage

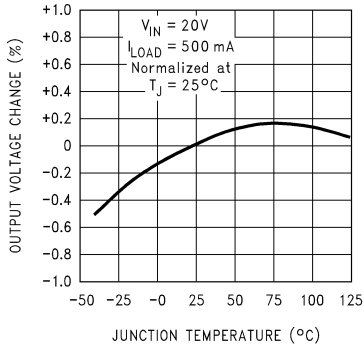

Line Regulation

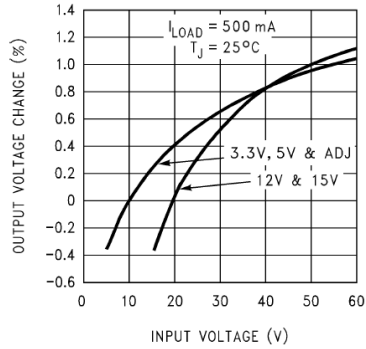

Feedback Pin Current

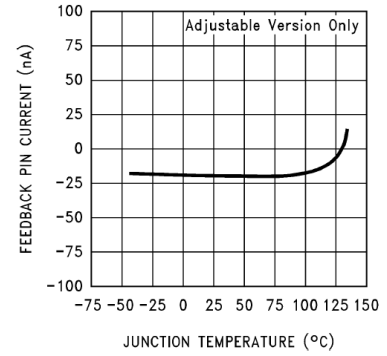

Current Limit

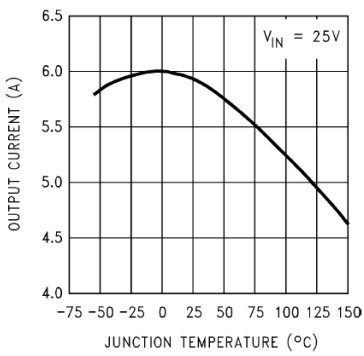

Standby Quiescent Current

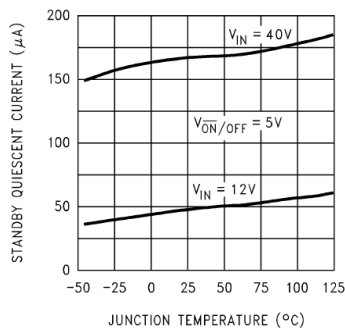

APPLICATION INFORMATION

As in any switching regulator, layout is very important. Rapidly switching currents associated with wiring inductance generate voltage transients which can cause problems. For minimal inductance and ground loops, the length of the leads indicated by heavy lines should be kept as short as possible. Single-point grounding (as indicated) or ground plane construction should be used for best results. When using the Adjustable version, physically locate the programming resistors near the regulator, to keep the sensitive feedback wiring short.

- Fixed Output Voltage Version

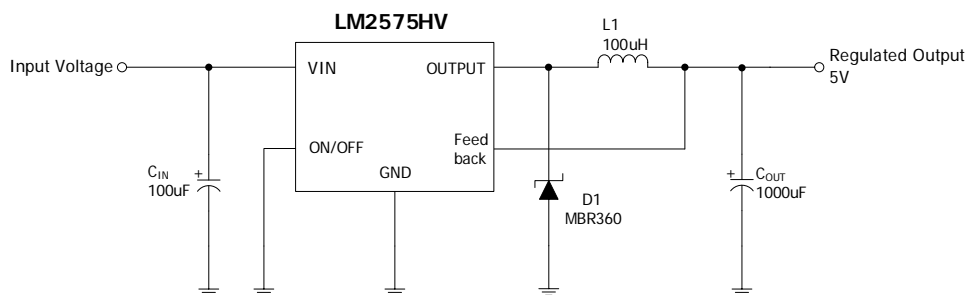

- Adjustable Output Voltage Version

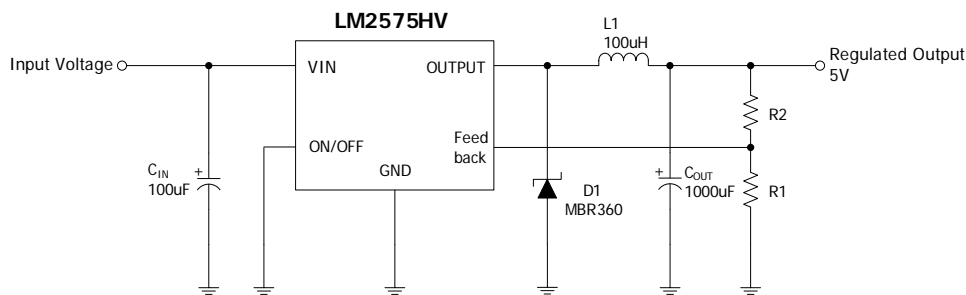

$$* V_{OUT} = V_{REF} \left(1 + \frac{R2}{R1}\right)$$

$$* R2 = R1 \left(\frac{V_{OUT}}{V_{REF}} - 1\right)$$

where $V_{REF} = 1.23V$, $R1$ between $1K\Omega$ and $5K\Omega$.

- C_{IN} : 100µF, Aluminum Electrolytic
- C_{OUT} : 1000µF, Aluminum Electrolytic
- D1 - Schottky Diode
- L1 : 100µH
- R1 : 2K
- R2 : 6.12K

REVISION NOTICE

The description in this datasheet can be revised without any notice to describe its electrical characteristics properly.