

KEMET Part Number: SSR10H-13097
(UALR10H1309700)

KEMET, SSR10V/H, AC Line Filters, Common Mode, 9700 uH

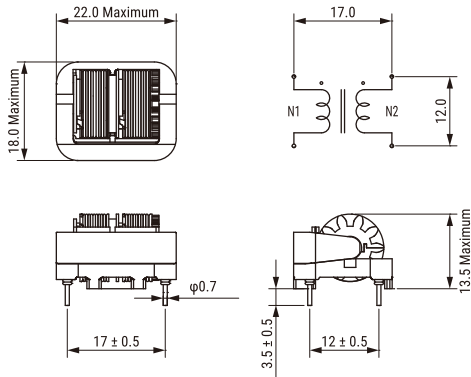

Dimensions

L	22mm MAX
T	18mm MAX
H	13.5mm MAX
LL	3.5mm +/-0.5mm
S	17mm +/-0.5mm

Packaging Specifications

Packaging:	Tray
Packaging Quantity:	300
Weight:	9 g

General Information

Series:	SSR10V/H
Style:	Through-Hole
Features:	Small Standard Common Mode, High Permeability, Compact Size, Low Profile, Light Weight, High Impedance, Strong Inductance
RoHS:	Yes
Miscellaneous:	55 (K) Temperature Rise Max.

Specifications

Voltage AC:	250 VAC
Inductance:	9.7 mH (10 kHz)
Current:	1.3 A
Temperature Range:	-25/+120°C
DC Resistance:	270 mOhms

Statements of suitability for certain applications are based on our knowledge of typical operating conditions for such applications, but are not intended to constitute - and we specifically disclaim - any warranty concerning suitability for a specific customer application or use. This Information is intended for use only by customers who have the requisite experience and capability to determine the correct products for their application. Any technical advice inferred from this Information or otherwise provided by us with reference to the use of our products is given gratis, and we assume no obligation or liability for the advice given or results obtained.