

# ST-17P1N8A8K03S - Cable connector



1618683

<https://www.phoenixcontact.com/us/products/1618683>

Please be informed that the data shown in this PDF document is generated from our online catalog. Please find the complete data in the user documentation. Our general terms of use for downloads are valid.



Cable connector, straight, SPEEDCON, M17, number of positions: 17, contact connection type: Pin, shielded: yes, degree of protection: IP67, cable diameter range: 5 mm ... 9.2 mm, number of positions: 17, connection method: Crimp connection, Alternative product in accordance with RoHS II without Exemption 6c (Pb < 0.1 %) item no.: 1243277

## Your advantages

- Reduced size: ideal for compact devices
- Consistent EMC protection for reliable connection solutions in the industrial environment
- Crimping connection: vibration- and temperature-resistant assembly
- Flexible use: reliably connect various cable diameters

## Commercial data

Item number	1618683
Packing unit	1 pc
Minimum order quantity	1 pc
Sales key	AB31
Product key	ABRADB
Catalog page	Page 64 (C-2-2019)
GTIN	4046356792127
Weight per piece (including packing)	37.2 g
Weight per piece (excluding packing)	37.2 g
Customs tariff number	85366990
Country of origin	DE

## Technical data

### Notes

#### Safety note

<p>Safety note</p>	<p>WARNING: The connectors may not be plugged in or disconnected under load. Ignoring the warning or improper use may damage persons and/or property.</p> <ul style="list-style-type: none"> <li>• WARNING: Commission properly functioning products only. The products must be regularly inspected for damage. Decommission defective products immediately. Replace damaged products. Repairs are not possible.</li> <li>• WARNING: Only electrically qualified personnel may install and operate the product. They must observe the following safety notes. The qualified personnel must be familiar with the basics of electrical engineering. They must be able to recognize and prevent danger. The relevant symbol on the packaging indicates that only personnel familiar with electrical engineering are allowed to install and operate the product.</li> <li>• The products are suitable for applications in plant, controller, and electrical device engineering.</li> <li>• When operating the connectors in outdoor applications, they must be separately protected against environmental influences.</li> <li>• Assembled products may not be manipulated or improperly opened.</li> <li>• Only use mating connectors that are specified in the technical data of the standards listed (e.g. the ones listed in the product accessories online at <a href="https://www.phoenixcontact.com/products">phoenixcontact.com/products</a>).</li> <li>• When using the product in direct connection with third-party manufacturers, the user is responsible.</li> <li>• For operating voltages &gt; 50 V AC, conductive connector housings must be grounded</li> <li>• Ensure that the protective or functional ground has been properly connected.</li> <li>• VDE 0100/1.97 § 411.1.3.2 and DIN EN 60 204/11.98 § 14.1.3 are applicable when combining several circuits in a cable and/or connector</li> <li>• Only use tools recommended by Phoenix Contact</li> <li>• The installation notes/Design In documents online on the download page at <a href="https://www.phoenixcontact.com/products">phoenixcontact.com/products</a> must be observed for this product.</li> <li>• Operate the connector only when it is fully plugged in and interlocked.</li> <li>• Ensure that when laying the cable, the tensile load on the connectors does not exceed the upper limit specified in the standards.</li> <li>• Observe the minimum bending radius of the cable. Lay the cable without twisting it.</li> <li>• The connector warms up in normal operation. Depending on the ambient conditions, the surface of the connector can continue to warm up. In this case, the user is responsible for posting warnings (e.g. DIN EN ISO 13732-1:2008-12).</li> </ul>
--------------------	---

# ST-17P1N8A8K03S - Cable connector



1618683

<https://www.phoenixcontact.com/us/products/1618683>

## Product properties

Product type	Circular connector (cable-side)
Application	Feedback, signal
	Signal
Number of positions	17
Connection profile	17
Shielded	yes
Coding	N
Thread type	M17

## Material specifications

Seal material	FPM
Housing material	Metal

## Connection data

### Conductor connection

Connection method	Crimp connection
-------------------	------------------

## Electrical properties

### Contact

Contact diameter	0.6 mm
Max. current	3.6 A
Nominal voltage $U_N$	48 V AC 74 V DC
Overvoltage category	III
Degree of pollution	3
Rated surge voltage	1.5 kV

## Connector

Type	straight
Direction of rotation	Standard

### Connection 1

Head design	Pin
-------------	-----

## Cable/line

External cable diameter	5 mm ... 9.2 mm
-------------------------	-----------------

## Environmental and real-life conditions

### Ambient conditions

Degree of protection	IP67
Ambient temperature (operation)	-40 °C ... 125 °C
Altitude	3000 m

# ST-17P1N8A8K03S - Cable connector

1618683

<https://www.phoenixcontact.com/us/products/1618683>

## Drawings

Dimensional drawing

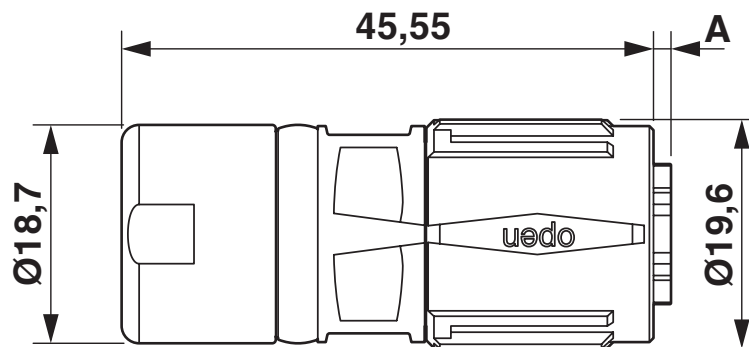

Technical drawings can be found under Downloads

Schematic diagram

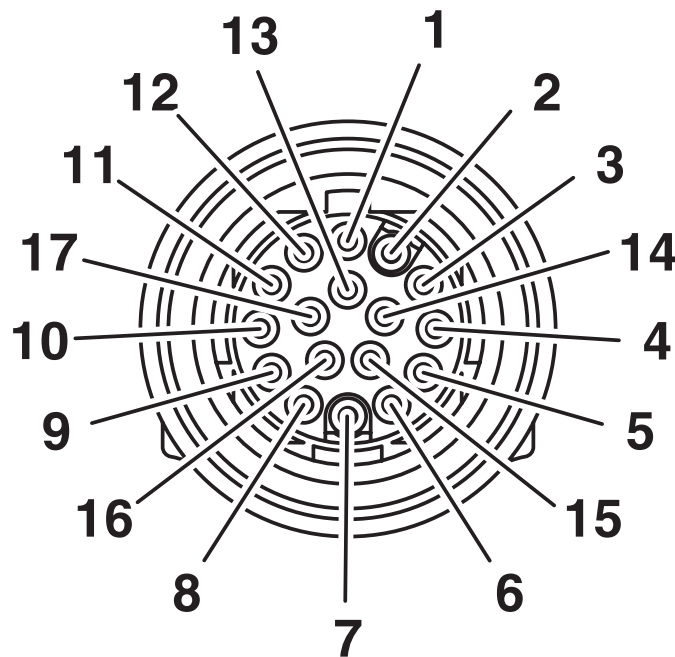

Connector pin assignment

# ST-17P1N8A8K03S - Cable connector



1618683

<https://www.phoenixcontact.com/us/products/1618683>

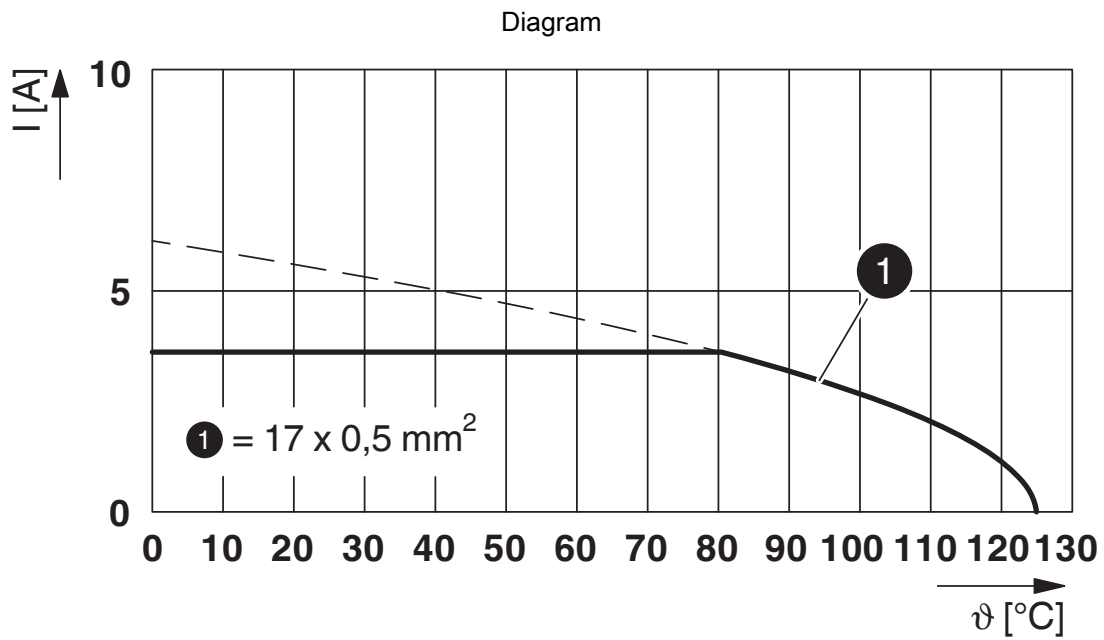

I = current strength,  $\vartheta$  = ambient temperature, 17x 3.6 A

# ST-17P1N8A8K03S - Cable connector





1618683

<https://www.phoenixcontact.com/us/products/1618683>

## Approvals

To download certificates, visit the product detail page: <https://www.phoenixcontact.com/us/products/1618683>

 <b>cUL Recognized</b> Approval ID: E335019-20111129				
	Nominal voltage $U_N$	Nominal current $I_N$	Cross section AWG	Cross section $\text{mm}^2$
	48 V	1 A	- 26	-

 <b>UL Recognized</b> Approval ID: E335019-20111129				
	Nominal voltage $U_N$	Nominal current $I_N$	Cross section AWG	Cross section $\text{mm}^2$
	48 V	1 A	- 26	-

 <b>UL Recognized</b> Approval ID: E153698-20140124				
	Nominal voltage $U_N$	Nominal current $I_N$	Cross section AWG	Cross section $\text{mm}^2$
	48 V	1 A	-	-

 <b>cUL Recognized</b> Approval ID: E153698-20140124				
	Nominal voltage $U_N$	Nominal current $I_N$	Cross section AWG	Cross section $\text{mm}^2$
	48 V	1 A	-	-

# ST-17P1N8A8K03S - Cable connector



1618683

<https://www.phoenixcontact.com/us/products/1618683>

## Classifications

### ECLASS

ECLASS-11.0	27440102
ECLASS-12.0	27440116
ECLASS-13.0	27440116

### ETIM

ETIM 9.0	EC002635
----------	----------

### UNSPSC

UNSPSC 21.0	39121400
-------------	----------

# ST-17P1N8A8K03S - Cable connector



1618683

<https://www.phoenixcontact.com/us/products/1618683>

## Environmental product compliance

### EU RoHS

Fulfills EU RoHS substance requirements	Yes
Exemption	6(c)

### China RoHS

Environment friendly use period (EFUP)	EFUP-50
	An article-related China RoHS declaration table can be found in the download area for the respective article under "Manufacturer declaration". For all articles with EFUP-E, no China RoHS declaration table issued and required.

### EU REACH SVHC

REACH candidate substance (CAS No.)	Lead(CAS: 7439-92-1)
SCIP	c2929a0d-50ad-4aef-8dce-ce4ba5bd4838

# ST-17P1N8A8K03S - Cable connector



1618683

<https://www.phoenixcontact.com/us/products/1618683>

## Accessories

### ST-06KP010 - Crimp contact

1607577

<https://www.phoenixcontact.com/us/products/1607577>



Crimp contact, Pin, turned, contact diameter: 0.6 mm, crimp range: 0.06 mm<sup>2</sup> ... 0.25 mm<sup>2</sup>, Alternative product in accordance with RoHS II without Exemption 6c (Pb < 0.1 %) item no.: 1242311

---

### ST-06KP020 - Crimp contact

1607578

<https://www.phoenixcontact.com/us/products/1607578>



Crimp contact, Pin, turned, contact diameter: 0.6 mm, crimp range: 0.14 mm<sup>2</sup> ... 0.34 mm<sup>2</sup>, Alternative product in accordance with RoHS II without Exemption 6c (Pb < 0.1 %) item no.: 1242311

## ST-17P1N8A8K03S - Cable connector

1618683

<https://www.phoenixcontact.com/us/products/1618683>



## ST-06KP030 - Crimp contact

1607579

<https://www.phoenixcontact.com/us/products/1607579>



Crimp contact, Pin, turned, contact diameter: 0.6 mm, crimp range: 0.34 mm<sup>2</sup> ... 0.5 mm<sup>2</sup>, Alternative product in accordance with RoHS II without Exemption 6c (Pb < 0.1 %) item no.: 1242312

---

## ST-Z0024 - Protective cap

1621904

<https://www.phoenixcontact.com/us/products/1621904>



Plastic protection cap for connectors with M17 compact knurled nut and M17 compact SPEEDCON knurled nut

# ST-17P1N8A8K03S - Cable connector

1618683

<https://www.phoenixcontact.com/us/products/1618683>



## ST-Z0016 - Color coding

1617993

<https://www.phoenixcontact.com/us/products/1617993>

Color coding, color: green



---

## ST-Z0017 - Color coding

1618049

<https://www.phoenixcontact.com/us/products/1618049>

Color coding, color: orange



# ST-17P1N8A8K03S - Cable connector

1618683

<https://www.phoenixcontact.com/us/products/1618683>



## ST-Z0018 - Color coding

1618050

<https://www.phoenixcontact.com/us/products/1618050>

Color coding, color: black



---

## PROT-M17PRO-IT-IP20 - Plastic protective cap

1055709

<https://www.phoenixcontact.com/us/products/1055709>

Plastic protective cap, M17, degree of protection: IP20, series: M17 PRO



---

Phoenix Contact 2024 © - all rights reserved  
<https://www.phoenixcontact.com>

Phoenix Contact USA  
586 Fulling Mill Road  
Middletown, PA 17057, United States  
(+717) 944-1300  
[info@phoenixcon.com](mailto:info@phoenixcon.com)