



MICROCHIP

Explorer 8 Development Board User's Guide

Note the following details of the code protection feature on Microchip devices:

- Microchip products meet the specification contained in their particular Microchip Data Sheet.
- Microchip believes that its family of products is one of the most secure families of its kind on the market today, when used in the intended manner and under normal conditions.
- There are dishonest and possibly illegal methods used to breach the code protection feature. All of these methods, to our knowledge, require using the Microchip products in a manner outside the operating specifications contained in Microchip's Data Sheets. Most likely, the person doing so is engaged in theft of intellectual property.
- Microchip is willing to work with the customer who is concerned about the integrity of their code.
- Neither Microchip nor any other semiconductor manufacturer can guarantee the security of their code. Code protection does not mean that we are guaranteeing the product as "unbreakable."

Code protection is constantly evolving. We at Microchip are committed to continuously improving the code protection features of our products. Attempts to break Microchip's code protection feature may be a violation of the Digital Millennium Copyright Act. If such acts allow unauthorized access to your software or other copyrighted work, you may have a right to sue for relief under that Act.

Information contained in this publication regarding device applications and the like is provided only for your convenience and may be superseded by updates. It is your responsibility to ensure that your application meets with your specifications. MICROCHIP MAKES NO REPRESENTATIONS OR WARRANTIES OF ANY KIND WHETHER EXPRESS OR IMPLIED, WRITTEN OR ORAL, STATUTORY OR OTHERWISE, RELATED TO THE INFORMATION, INCLUDING BUT NOT LIMITED TO ITS CONDITION, QUALITY, PERFORMANCE, MERCHANTABILITY OR FITNESS FOR PURPOSE. Microchip disclaims all liability arising from this information and its use. Use of Microchip devices in life support and/or safety applications is entirely at the buyer's risk, and the buyer agrees to defend, indemnify and hold harmless Microchip from any and all damages, claims, suits, or expenses resulting from such use. No licenses are conveyed, implicitly or otherwise, under any Microchip intellectual property rights unless otherwise stated.

Trademarks

The Microchip name and logo, the Microchip logo, dsPIC, FlashFlex, flexPWR, JukeBlox, KEELOQ, KEELOQ logo, Kleer, LANCheck, MediaLB, MOST, MOST logo, MPLAB, OptoLyzer, PIC, PICSTART, PIC³² logo, RightTouch, SpyNIC, SST, SST Logo, SuperFlash and UNI/O are registered trademarks of Microchip Technology Incorporated in the U.S.A. and other countries.

The Embedded Control Solutions Company and mTouch are registered trademarks of Microchip Technology Incorporated in the U.S.A.

Analog-for-the-Digital Age, BodyCom, chipKIT, chipKIT logo, CodeGuard, dsPICDEM, dsPICDEM.net, ECAN, In-Circuit Serial Programming, ICSP, Inter-Chip Connectivity, KleerNet, KleerNet logo, MiWi, MPASM, MPF, MPLAB Certified logo, MPLIB, MPLINK, MultiTRAK, NetDetach, Omniscient Code Generation, PICDEM, PICDEM.net, PICkit, PICtail, RightTouch logo, REAL ICE, SQI, Serial Quad I/O, Total Endurance, TSHARC, USBCheck, VariSense, ViewSpan, WiperLock, Wireless DNA, and ZENA are trademarks of Microchip Technology Incorporated in the U.S.A. and other countries.

SQTP is a service mark of Microchip Technology Incorporated in the U.S.A.

Silicon Storage Technology is a registered trademark of Microchip Technology Inc. in other countries.

GestIC is a registered trademark of Microchip Technology Germany II GmbH & Co. KG, a subsidiary of Microchip Technology Inc., in other countries.

All other trademarks mentioned herein are property of their respective companies.

© 2015, Microchip Technology Incorporated, Printed in the U.S.A., All Rights Reserved.

ISBN: 978-1-63277-689-1

QUALITY MANAGEMENT SYSTEM
CERTIFIED BY DNV
== ISO/TS 16949 ==

Microchip received ISO/TS-16949:2009 certification for its worldwide headquarters, design and wafer fabrication facilities in Chandler and Tempe, Arizona; Gresham, Oregon and design centers in California and India. The Company's quality system processes and procedures are for its PIC[®] MCUs and dsPIC[®] DSCs, KEELOQ[®] code hopping devices, Serial EEPROMs, microperipherals, nonvolatile memory and analog products. In addition, Microchip's quality system for the design and manufacture of development systems is ISO 9001:2000 certified.

Table of Contents

Preface 5

Chapter 1. Overview

 1.1 Introduction 11

 1.2 Development Kit Contents 11

 1.3 Explorer 8 Development Board 12

 1.4 On-Board Jumper Configurations 13

 1.5 Sample Devices 17

 1.6 Sample Programs 17

Chapter 2. Getting Started

 2.1 Explorer 8 with Pre-Programmed Device 19

 2.2 Board with PIM Attached Devices 21

 2.3 Programming the Microcontrollers 21

 2.3.1 Programming Requirements 21

 2.3.2 Opening the Program in MPLAB® X IDE 22

 2.3.3 Programming the Microcontroller 23

 2.4 Connecting to Host PC for USB Communication 24

 2.4.1 USB-to-UART Interface 25

 2.4.2 USB-to-I2C Interface 25

 2.5 Powering the Board 26

 2.5.1 External 9V Power Supply 26

 2.5.2 USB Power 26

 2.6 Selecting Vdd Values 27

 2.6.1 Varying the Device Voltage 27

 2.6.2 Calculating other Vdd Values 27

Chapter 3. Tutorial Program

 3.1 Tutorial Program Operation 29

 3.2 Source Code and Data Sheets 31

Appendix A. Hardware Details

 A.1 Hardware Elements 33

 A.1.1 Processor Sockets 33

 A.1.2 Display 33

 A.1.3 Power Supply 33

 A.1.4 Micro USB Port 34

 A.1.5 Switches 34

 A.1.6 Oscillator Options 34

 A.1.7 Analog Input (Potentiometer) 34

 A.1.8 ICD Connector 34

 A.1.9 PICKIT™ Connector 34

 A.1.10 PICtail™ and PICtail Plus Expansion Connectors 35

 A.1.11 mikroBUS™ Connectors 35

Explorer 8 Development Board User's Guide

A.1.12 Pmod™ Connectors	35
A.1.13 Configurable In-line Connector	35
A.1.14 LCD	35
A.1.15 Sample Devices	36
A.2 Board Layout and Schematics	37
Worldwide Sales and Service	41

Preface

NOTICE TO CUSTOMERS

All documentation becomes dated, and this manual is no exception. Microchip tools and documentation are constantly evolving to meet customer needs, so some actual dialogs and/or tool descriptions may differ from those in this document. Please refer to our web site (www.microchip.com) to obtain the latest documentation available.

Documents are identified with a “DS” number. This number is located on the bottom of each page, in front of the page number. The numbering convention for the DS number is “DSXXXXXXXXA”, where “XXXXXXXX” is the document number and “A” is the revision level of the document.

For the most up-to-date information on development tools, see the MPLAB® IDE online help. Select the Help menu, and then Topics to open a list of available online help files.

INTRODUCTION

This chapter contains general information that will be useful to know before using the Explorer 8 Development Board. Items discussed in this chapter include:

- Document Layout
- Conventions Used in this Guide
- Warranty Registration
- Recommended Reading
- The Microchip Web Site
- Development Systems Customer Change Notification Service
- Customer Support
- Document Revision History

DOCUMENT LAYOUT

This document describes how to use the Explorer 8 Development Board as a tool to emulate and debug firmware on a target board. The document is organized as follows:

- [Chapter 1. Overview](#)
- [Chapter 2. Getting Started](#)
- [Chapter 3. Tutorial Program](#)
- [Appendix A. Hardware Details](#)

Explorer 8 Development Board User's Guide

CONVENTIONS USED IN THIS GUIDE

This manual uses the following documentation conventions:

DOCUMENT CONVENTIONS

Description	Represents	Examples
Arial font:		
Italic characters	Referenced books	<i>MPLAB[®] IDE User's Guide</i>
	Emphasized text	...is the <i>only</i> compiler...
Initial caps	A window	the Output window
	A dialog	the Settings dialog
	A menu selection	select Enable Programmer
Quotes	A field name in a window or dialog	"Save project before build"
Underlined, italic text with right angle bracket	A menu path	<u><i>File>Save</i></u>
Bold characters	A dialog button	Click OK
	A tab	Click the Power tab
N'Rnnnn	A number in verilog format, where N is the total number of digits, R is the radix and n is a digit.	4'b0010, 2'hF1
Text in angle brackets < >	A key on the keyboard	Press <Enter>, <F1>
Courier New font:		
Plain Courier New	Sample source code	#define START
	Filenames	autoexec.bat
	File paths	c:\mcc18\h
	Keywords	_asm, _endasm, static
	Command-line options	-Opa+, -Opa-
	Bit values	0, 1
	Constants	0xFF, 'A'
Italic Courier New	A variable argument	<i>file.o</i> , where <i>file</i> can be any valid filename
Square brackets []	Optional arguments	mcc18 [options] <i>file</i> [options]
Curly brackets and pipe character: { }	Choice of mutually exclusive arguments; an OR selection	errorlevel {0 1}
Ellipses...	Replaces repeated text	var_name [, var_name...]
	Represents code supplied by user	void main (void) { ... }

WARRANTY REGISTRATION

Please complete the enclosed Warranty Registration Card and mail it promptly. Sending in the Warranty Registration Card entitles users to receive new product updates. Interim software releases are available at the Microchip web site.

RECOMMENDED READING

This user's guide describes how to use the Explorer 8 Development Board. The following documents are available and recommended as supplemental reference resources.

Explorer 8 Development Board Layout and Schematic Quick Start Guide (DS40001805)

This quick start guide provides a brief overview on the Explorer 8 Development Board's functionalities, features and capabilities.

MPLAB® ICD 3 In-Circuit Debugger User's Guide (DS51766)

This document provides all the necessary information on the MPLAB ICD 3 In-Circuit Debugger's operation, installation, general setup and tutorial details. The MPLAB ICD 3 is a cost-effective, high-speed hardware debugger/programmer developed by Microchip for PIC® microcontrollers and Digital Signal Controllers (DSCs).

MPLAB® REAL ICE™ In-Circuit Emulator User's Guide for MPLAB X IDE (DS50002085)

This user's guide describes how to use the MPLAB REAL ICE In-Circuit Emulator as a development tool to emulate and debug firmware on a target board, as well as how to program devices. It provides details on the emulator's operation, features, troubleshooting, software, hardware reference and emulator accessories.

PICkit™ 3 In-Circuit Debugger/Programmer User's Guide for MPLAB® X IDE (DS52116)

This user's guide describes the PICkit 3 In-Circuit Debugger/Programmer's operation, usage, troubleshooting methods and hardware specifications. The PICkit 3 can be implemented as a debugger or development programmer for Microchip PIC MCUs and DSCs that are based on In-Circuit Serial Programming™ (ICSP™) and Enhanced ICSP 2-wire serial interfaces.

Explorer 8 Development Board User's Guide

THE MICROCHIP WEB SITE

Microchip provides online support via our web site at www.microchip.com. This web site is used as a means to make files and information easily available to customers. Accessible by using your favorite Internet browser, the web site contains the following information:

- **Product Support** – Data sheets and errata, application notes and sample programs, design resources, user's guides and hardware support documents, latest software releases and archived software.
- **General Technical Support** – Frequently Asked Questions (FAQs), technical support requests, online discussion groups, Microchip consultant program member listing.
- **Business of Microchip** – Product selector and ordering guides, latest Microchip press releases, listing of seminars and events, listings of Microchip sales offices, distributors and factory representatives.

DEVELOPMENT SYSTEMS CUSTOMER CHANGE NOTIFICATION SERVICE

Microchip's customer notification service helps keep customers current on Microchip products. Subscribers will receive e-mail notification whenever there are changes, updates, revisions or errata related to a specified product family or development tool of interest.

To register, access the Microchip web site at www.microchip.com, click on Customer Change Notification and follow the registration instructions.

The Development Systems product group categories are:

- **Compilers** – The latest information on Microchip C compilers, assemblers, linkers and other language tools. These include the MPLAB XC Compilers that support all 8-, 16- and 32-bit PIC MCUs and dsPIC[®] DSCs.
- **Emulators** – The latest information on Microchip in-circuit emulators. This includes the MPLAB REAL ICE In-Circuit Emulator.
- **In-Circuit Debuggers** – The latest information on the Microchip in-circuit debuggers. This includes the MPLAB ICD 3 In-Circuit Debugger and the PICkit 3 In-Circuit Debugger.
- **MPLAB[®] X IDE** – The latest information on Microchip MPLAB X IDE, the Integrated Development Environment for development systems tools which can be run on Windows[®], Mac OS[®] and LINUX[®] operating systems.
- **Programmers** – The latest information on Microchip programmers. These include the device (production) programmers MPLAB REAL ICE in-circuit emulator and MPLAB ICD 3 in-circuit debugger, and the development (non-production) programmer PICkit 3.

CUSTOMER SUPPORT

Users of Microchip products can receive assistance through several channels:

- Distributor or Representative
- Local Sales Office
- Field Application Engineer (FAE)
- Technical Support

Customers should contact their distributor, representative or field application engineer (FAE) for support. Local sales offices are also available to help customers.

Technical support is available through the web site at:

<http://www.microchip.com/support>.

DOCUMENT REVISION HISTORY

Revision A (August, 2015)

Initial release of the document.

Explorer 8 Development Board User's Guide

NOTES:

Chapter 1. Overview

1.1 INTRODUCTION

The Explorer 8 Development Board is one of the latest development boards for evaluating and demonstrating the capabilities and features of Microchip's 8-bit PIC[®] MCUs. This board supports 8/14/20/28/40-pin DIP and 44/64/80-pin PIM-mounted PIC MCUs.

This board is fully populated with two fixed and one variable power supply, a 16x2 Character LCD module, a pair of mikroBUS[™] Click[™] board headers to accommodate a variety of plug-in modules, a pair of Digilent Pmod[™] connectors, an in-line completely configurable connector, PICtail[™] connectors and a USB-to-serial/I²C converter. The Explorer 8 is fully compatible with the MPLAB[®] Code Configurator and MPLAB X v3.00 or later.

1.2 DEVELOPMENT KIT CONTENTS

The Explorer 8 Development Board comes with the following:

- Explorer 8 Development Board (DM160228)
- Pre-programmed PIC16F1719
- Micro USB cable

If the kit is missing any of these parts, please contact the nearest Microchip sales office listed in the back of this publication.

The MPLAB X Integrated Development Environment (IDE) is a free, integrated software tool set for application development and debugging. Compilers and other board-compatible software and hardware tools can be purchased.

To download the MPLAB X IDE software and documentation, or get information on the other tools, visit www.microchip.com/devtools.

Explorer 8 Development Board User's Guide

1.3 EXPLORER 8 DEVELOPMENT BOARD

The Explorer 8 Development Board has the following hardware features. Each feature's number corresponds to the number in [Figure 1-1](#), showing the feature's location on the board:

1. MCP2221 USB-to-UART/I²C serial converter (U3)
2. 16x2 Character LCD (LCD1)
3. MCP23S17 I/O Expander for LCD Interface (U4)
4. Eight blue LEDs (D1 to D8).
5. Male header pins for attaching Plug-in-Modules (U1A)
6. Socket for attaching 40-pin PIC MCUs (J8)
7. Socket for attaching 28-pin PIC MCUs (J13)
8. Socket for attaching 8/14/20-pin PIC MCUs (J10)
9. mikroBUS headers for attaching mikroBUS compatible boards (J32 and J35)
10. Two push button switches for external stimulus (S1 and S2)
11. PICtail Expansion Connectors for PICtail Daughter Boards (J3, J5, J11 and J28)
12. PICtail Plus Card Edge Modular Expansion Connectors for PICtail Plus Daughter Boards (J19)
13. Test Points for 5.0V (TP1 and TP7), 3.3V (TP6) and V_VAR (TP5). V_VAR is the variable voltage and is equal to the device VDD and its associated logic
14. 20-pin in-line expansion connector (J33)
15. 8 MHz crystal for device external oscillator (Y1)
16. Digilent Pmod compatible connectors (J17 and J20)
17. 10 kΩ Potentiometer for analog inputs (R25)
18. Variable Power Indicator LED (D9)
19. 3.3V Power Indicator (LD2)
20. 5.0V Power Indicator (LD1)
21. 5.0V (U5), 3.3V (U1) and Variable (U2) power supplies
22. Barrel connector for 9V DC Supply (J1)
23. RJ11 connector for ICSP programming/debugging using REAL ICE and ICD 3 (J26)
24. 6-pin male header for ICSP programming/debugging using PICKit 3 (J12)
25. Push button switch on MCLR for external Reset (S3)
26. Micro USB socket for USB communication and/or USB power (J18)

FIGURE 1-1: EXPLORER 8 DEVELOPMENT BOARD

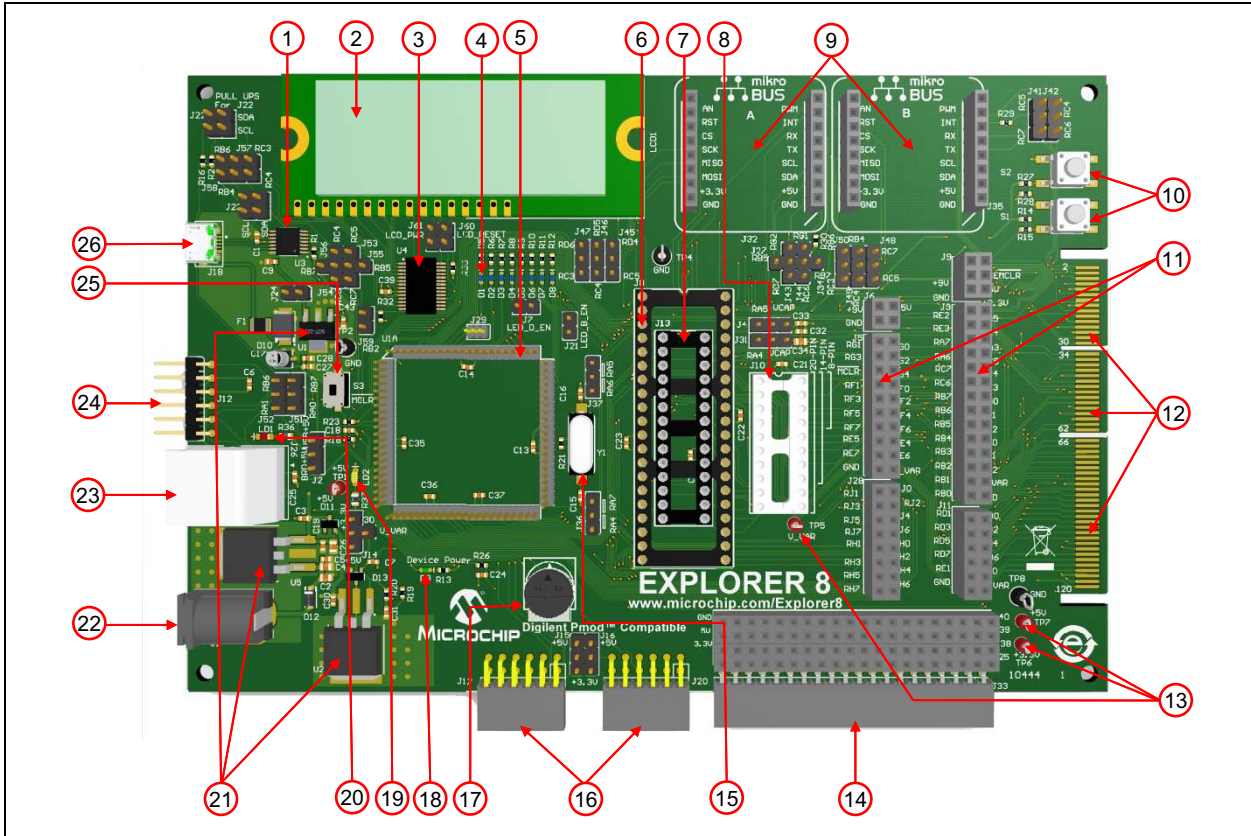

1.4 ON-BOARD JUMPER CONFIGURATIONS

The Explorer 8 Development Board allows the user to connect or disconnect components from PIC MCU pins or from other on-board components through associated jumpers. [Table 1-1](#) and [Figure 1-2](#) provide details and examples for these connections.

TABLE 1-1: ON-BOARD JUMPERS DESCRIPTION AND SAMPLE CONFIGURATION



Label	Jumper/s	Description	Configuration
MCU Interface to MCP2221 USB-to-I²C/UART Converter⁽¹⁾			
1	J22	Pulls up the configured I ² C SCL pin (see J57) and SDA pin (see J58).	SDA SCL
2	J57	Connects the microcontroller I ² C SCL pin to the MCP2221 SCL pin (see Label 3). E.g. RC3 is configured as the microcontroller I ² C SCL pin.	RB6 RC3
	J58	Connects the microcontroller I ² C SDA pin to the MCP2221 SDA pin (see Label 3). E.g. RC4 is configured as the microcontroller I ² C SDA pin.	RB4 RC4
3	J23	Connects the microcontroller I ² C SCL and SDA pins to the MCP2221 SCL and SDA pins, respectively.	SCL SDA

Explorer 8 Development Board User's Guide

TABLE 1-1: ON-BOARD JUMPERS DESCRIPTION AND SAMPLE CONFIGURATION (CONTINUED)

Label	Jumper/s	Description	Configuration
4	J53, J55	Connects the microcontroller UART RX pin to the MCP2221 TX pin. E.g. RC7 is configured as the microcontroller RX pin.	
	J54, J56	Connects the microcontroller UART TX pin to the MCP2221 RX pin. E.g. RC6 is configured as the microcontroller TX pin.	
MCU Interface to MCP23S17 I/O Expander⁽¹⁾			
5	J60	Connects RB5 to the MCP23S17 I/O Expander RESET pin.	
	J59	Connects RA2 to the MCP23S17 I/O Expander Chip Select (CS) pin.	
MCU Interface to the LEDs⁽¹⁾			
6	J7	Connects LEDs D1 to D4 cathodes to ground to provide a continuous LED current path.	
	J21	Connects LEDs D5 to D8 cathodes to ground to provide a continuous LED current path.	
MCU Interface to J32 mikroBUSTM(1)			
7	J45	Connects the microcontroller SDO pin to the J32 mikroBUS MOSI (SPI Master Output Slave Input) pin. E.g. RC5 is configured as the microcontroller SDO pin.	
	J46	Connects the microcontroller SDI pin to the J32 mikroBUS MISO (SPI Master Input Slave Output) pin E.g. RC4 is configured as the microcontroller SDI pin.	
	J47	Connects the microcontroller SCK pin to the J32 mikroBUS SCK (SPI Clock) pin. E.g. RC3 is configured as the microcontroller SCK pin.	
8	J27, J43	Connects the microcontroller RX pin to the J32 mikroBUS UART RX pin. E.g. RC7 is configured as the microcontroller RX pin.	
	J34, J44	Connects the microcontroller TX pin to the J32 mikroBUS UART TX pin. E.g. RC6 is configured as the microcontroller TX pin.	

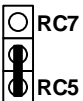
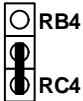
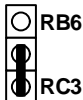
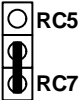
TABLE 1-1: ON-BOARD JUMPERS DESCRIPTION AND SAMPLE CONFIGURATION (CONTINUED)

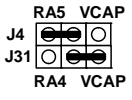
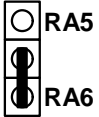
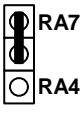
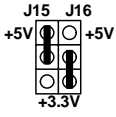
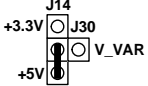
Label	Jumper/s	Description	Configuration
MCU Interface to J35 mikroBUS⁽¹⁾			
9	J48	Connects the microcontroller SDO pin to the J35 mikroBUS MOSI (SPI Master Output Slave Input) pin. E.g. RC5 is configured as the microcontroller SDO pin.	
	J49	Connects the microcontroller SDI pin to the J35 mikroBUS MISO (SPI Master Input Slave Output) pin. E.g. RC4 is configured as the microcontroller SDI pin.	
	J50	Connects the microcontroller SCK pin to the J35 mikroBUS SCK (SPI Clock) pin. E.g. RC3 is configured as the microcontroller SCK pin.	
10	J41	Connects the microcontroller RX pin to the J35 mikroBUS UART RX pin. E.g. RC7 is configured as the microcontroller RX pin.	
	J42	Connects the microcontroller TX pin to the J35 mikroBUS UART TX pin. E.g. RC6 is configured as the microcontroller TX pin.	
Other Connections and Interfaces⁽¹⁾			
11	J4, J31	Connections depend whether RA5 and RA4 are configured as an I/O port or as a VCAP pin. E.g. RA5 is configured as an I/O port while RA4 as a VCAP pin.	
12	J37	Selects whether RA6 or the RA5 pin be connected to the external 8 MHz crystal (Y1). E.g. The 8 MHz crystal is connected to the MCU OSC2/RA5 pin.	
13	J36	Selects whether RA7 or the RA4 pin be connected to the external 8 MHz crystal (Y1). E.g. The 8 MHz crystal is connected to the MCU OSC1/RA7 pin.	
14	J15, J16	Option to power the Digilent Pmod with 3.3V or 5V. E.g. J17 Pmod is supplied with 5V while J20 Pmod is supplied with 3.3V	
15	J14, J30	Selects either 3.3V, 5.0V or a variable voltage for the board's supply. E.g. The board is supplied with 5V.	

Explorer 8 Development Board User's Guide

TABLE 1-1: ON-BOARD JUMPERS DESCRIPTION AND SAMPLE CONFIGURATION (CONTINUED)

Label	Jumper/s	Description	Configuration
16	J2	Selects whether to supply 5V power to the board via USB or the output of the 5V regulator. E.g. The board is USB-powered.	<p>USB +5V BRD +5V</p>
17	J51, J52	Connects the PGD and PGC pins of the PICKIT™ 3, ICD 3 or REAL ICE™ to the PIC® MCU ICSPDAT and ICSPCLK, respectively for ICSP™ programming	<p>J52 J51 RB6 RB7 RA1 RA0</p>
18	J61	Connects the LCD VDD pin to +5V supply.	<p>LCD_PWR</p>
19	J24	To supply a regulated 3.3V output.	<p>J24</p>

Note 1: Sample configurations only. Jumpers should always be disconnected for unused interfaces and devices.

FIGURE 1-2: EXPLORER 8 DEVELOPMENT BOARD JUMPER LOCATIONS

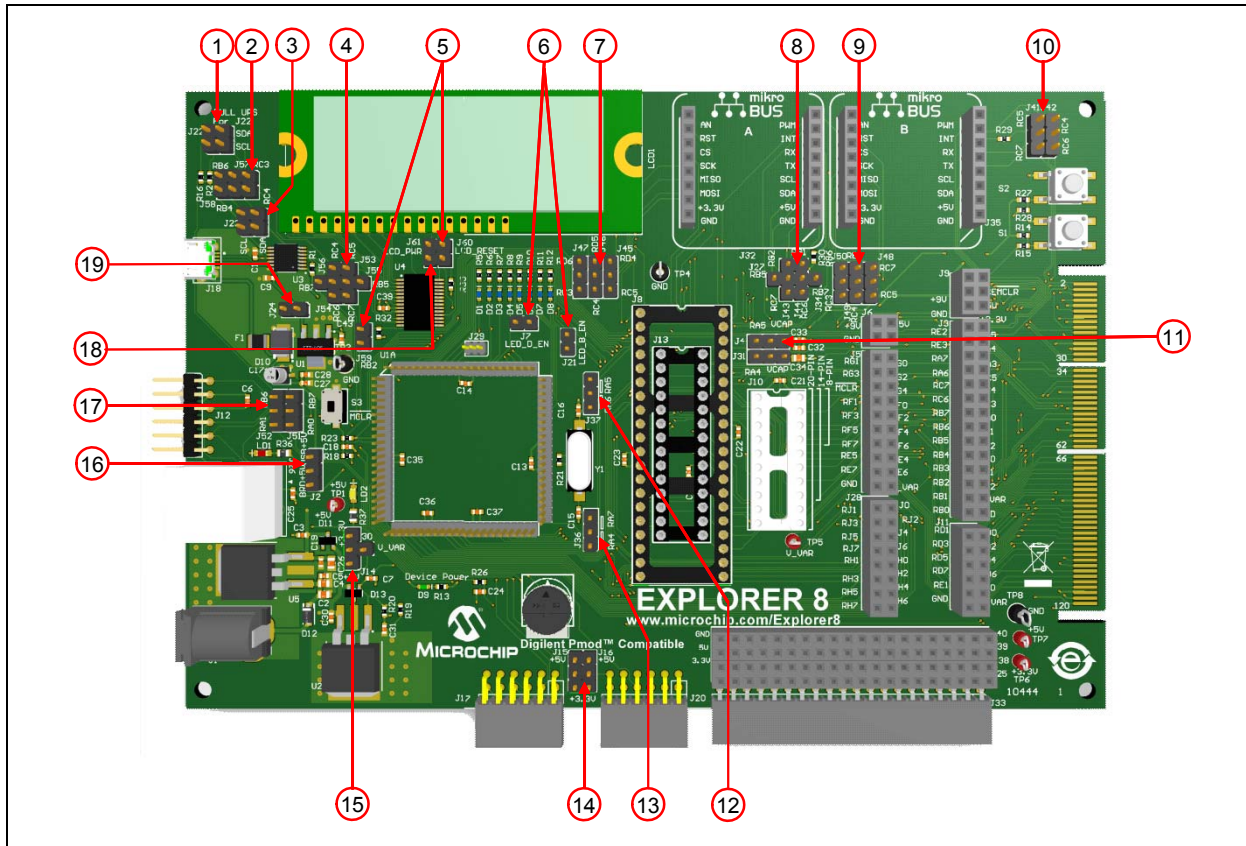

1.5 SAMPLE DEVICES

The Explorer 8 Development Board comes with a 40-pin PIC16F1719.

1.6 SAMPLE PROGRAMS

The Explorer 8 Development Board demonstration program can be downloaded from the Microchip web site (www.microchip.com/explorer8). This Demo Code can be used with the included sample device and with a REAL ICE (In-Circuit Emulator), MPLAB ICD 3 (programmer/debugger) or with a PICkit 3 (programmer/debugger). The Demo code was developed using the MPLAB Code Configurator (MCC). For more information on MCC, visit www.microchip.com/mcc.

For a complete list of available sample programs, schematics and additional collateral for the Explorer 8 Development Board, visit www.microchip.com/explorer8.

Explorer 8 Development Board User's Guide

NOTES:

Chapter 2. Getting Started

The Explorer 8 Demo Board is very flexible and may be used in a variety of ways. This section provides the different configurations of the board, and the required tools and equipment for each of them.







2.1 EXPLORER 8 WITH PRE-PROGRAMMED DEVICE

Several features of the Explorer 8 Demo Board can be demonstrated immediately by following the steps listed below:

1. Place the pre-programmed PIC16F1719 on the 40-pin socket of the Explorer 8 Development Board.
2. Ensure that the jumpers are on their proper configuration as shown in [Table 2-1](#). See [Section 1.4 “On-Board Jumper Configurations”](#) for jumper description and location.





Note: The table contains only a list of jumpers that are required to be setup for proper demonstration of the Explorer 8 Development Board using the pre-programmed device. Jumpers not listed in the table will have no effect on the demo program.

TABLE 2-1: JUMPER SETUP USING THE PRE-PROGRAMMED DEVICE

Jumper/s	Description	Configuration
J2	Power the board via USB	USB +5V BRD +5V 
J4	Use RA5 as an I/O pin	RA5 VCAP 
J7	Use LEDs D4 through D1	LED_D_EN 
J14	Use +5.0V Supply	+3.3V +5V 
J21	Use LEDs D8 through D5	LED_B_EN 
J36	Connect the 8 MHz Crystal to the device OSC1 pin to function as primary oscillator	RA7 RA4 

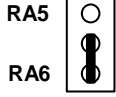
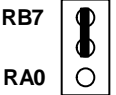
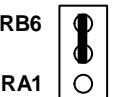
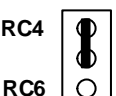
Explorer 8 Development Board User's Guide

TABLE 2-1: JUMPER SETUP USING THE PRE-PROGRAMMED DEVICE

Jumper/s	Description	Configuration
J37	Connect the 8 MHz Crystal to the device OSC2 pin to function as primary oscillator	
J51	For ICSP™ programming, connect the device to the PGD pin of PICKit™ 3, ICD 3 or REAL ICE™	
J52	For ICSP programming, connect the device to the PGC pin of PICKit™ 3, ICD 3 or REAL ICE™	
J54	For USB-to-UART communication	
J59	To send data to the LCD	
J60	To reset the MCP23S17 I/O Expander	
J61	Power the LCD module	

3. Apply power to the Explorer 8 Development Board using the Micro USB cable that comes with the kit. See [Section 2.6 “Selecting Vdd Values”](#).

The device can now be demonstrated using the tutorial program. See [Section 3.1 “Tutorial Program Operation”](#).

2.2 BOARD WITH PIM ATTACHED DEVICES

The Explorer 8 Development Board can also be used to demonstrate PIM-mounted 8-bit PIC microcontrollers. A Plug-in-Module (PIM) enables the attachment of 44/64/80-pin devices to the board.

To attach a PIM, simply seat the PIM in the 84-pin, elevated male connectors as shown in [Figure 2-1](#).

FIGURE 2-1: 84-PIN HEADER FOR PLUG-IN-MODULE (PIM)

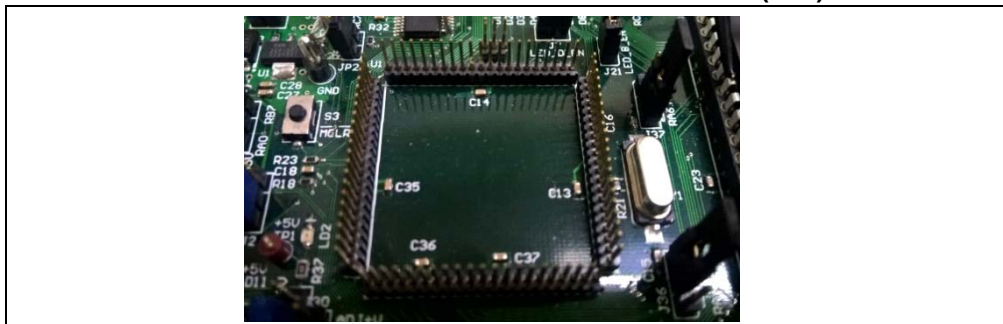

Make sure that the device mounted on the PIM is supplied with the appropriate voltage. See [Section 2.6 “Selecting Vdd Values”](#) and [Section 2.6.2 “Calculating other Vdd Values”](#) for supplies other than 5V and 3.3V.

Some PIMs also enable the board’s 5V output to be automatically reset to 3.3V.

For a list of microcontroller-compatible PIMs, go to www.microchip.com.

2.3 PROGRAMMING THE MICROCONTROLLERS

The Explorer 8 Development Board supports the ability to program a microcontroller through multiple options.

This section discusses:

- Programming Requirements
- Opening the Program in MPLAB X IDE
- Programming the Microcontroller Using ICD 3, REAL ICE and PICKit 3

2.3.1 Programming Requirements

To reprogram a sample device, the following are required:

- **Program source code** – The sample code is pre-loaded on the device, but user source code can be substituted. If this is done, the sample program can be restored by downloading the MPLAB X project file available at the Microchip web site.
- **An assembler or compiler** – The source code must be assembled or compiled into a hex file before it can be programmed into the device.
- **A programmer** – Once the code is in the hex file format, this device programs the microcontroller’s Flash memory. If the code protection bit(s) have not been programmed, the on-chip program memory can be read out for verification purposes.

Explorer 8 Development Board User's Guide

In meeting these requirements, the following items are to be taken into consideration:

- Code development and debugging – The free MPLAB X IDE software development tool includes a debugger and several other software tools as well as a unified graphical user interface (GUI) for working with other Microchip and third-party software and hardware tools.
- Assembler – The free MPLAB X IDE tool includes the MPASM™ assembler.
- Compiler – Microchip's MPLAB® XC8 Compiler is fully integrated for the MPLAB X IDE environment.
- Programmer – Microchip's MPLAB In-Circuit Debugger (ICD) 3, PICKit 3 In-Circuit Debugger/Programmer, or MPLAB REAL ICE In-Circuit Emulator can be used to program the device and all are fully integrated for the MPLAB X IDE environment.
- The MPLAB Code Configurator (MCC) – is Microchip's new tool for developing drivers and initializers featuring a very easy to use GUI. It is a free tool that integrates into MPLAB X, providing a very powerful development platform. For more information on MCC go to (www.microchip.com/mcc).

The MPLAB X IDE and the XC8 Compiler can be downloaded from the Microchip web site.

For a list of tools compatible with PIC microcontrollers, see the Microchip Development Tools web site at www.microchip.com/devtools.

2.3.2 Opening the Program in MPLAB® X IDE

The MPLAB X Integrated Development Environment (IDE) is a software program that runs on Windows®, MAC OS® and Linux® to develop code for PIC microcontrollers and Digital Signal Controllers (DSC).

This section describes how to open the `Explorer_8_Demo_MCC.X` project in MPLAB X IDE.

1. Download the `Explorer_8_Demo_MCC` project from Microchip's Explorer 8 web page (www.microchip.com/explorer8).
2. Launch the MPLAB X IDE application and select *File>Open Project> Explorer_8_Demo_MCC.X >Open Project* from the downloaded section. The project file will appear on the **Projects** area. If it is not the main project, set as main project.
3. Right click. *Explorer_8_Demo_MCC.X >Set as main project*.
4. If not already downloaded, download and install the MCC tool from the Plugins repository. This is done by the following:
 - Select Tools from the MPLAB X menu, then Plugins.
 - Select the **Available Plugins** tab and select the MPLAB Code Configurator
 - Go through the install process.
5. Once installed, go to the Tools menu in MPLAB X, select Embedded then MPLAB Code Configurator.
6. With MCC open, all the modules currently in the project used for the demo application can be seen.
7. The device is now ready to be built and programmed.

The next section will describe how to load the program into the microcontroller.

2.3.3 Programming the Microcontroller

Program the device using an ICD 3, REAL ICE or PICKit 3.

1. Connect the ICD 3 or REAL ICE as shown in [Figure 2-2](#). For PICKit 3, see [Figure 2-3](#).
2. Setup the jumpers. In addition to the jumper settings listed in [Section 2.1 “Explorer 8 with Pre-Programmed Device”](#), J51 and J52 should also be configured. See [Figure 2-2](#).
3. Power-up the Explorer 8 Development Board (see [Section 2.5 “Powering the Board”](#)).
4. Open the project on MPLAB X IDE (see [Section 2.3.2 “Opening the Program in MPLAB® X IDE”](#)).
5. Right click *Explorer 8 Demo MCC.X >Properties*. A pop-up window will appear as shown in [Figure 2-4](#).

FIGURE 2-2: ICD 3 CONNECTION AND JUMPER CONFIGURATION

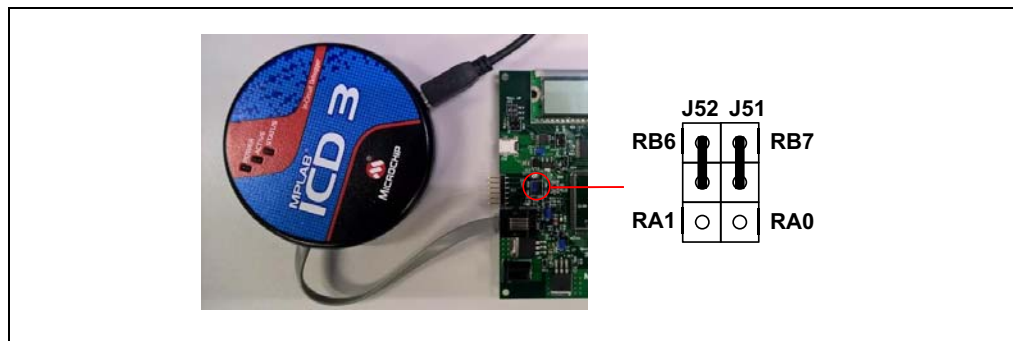
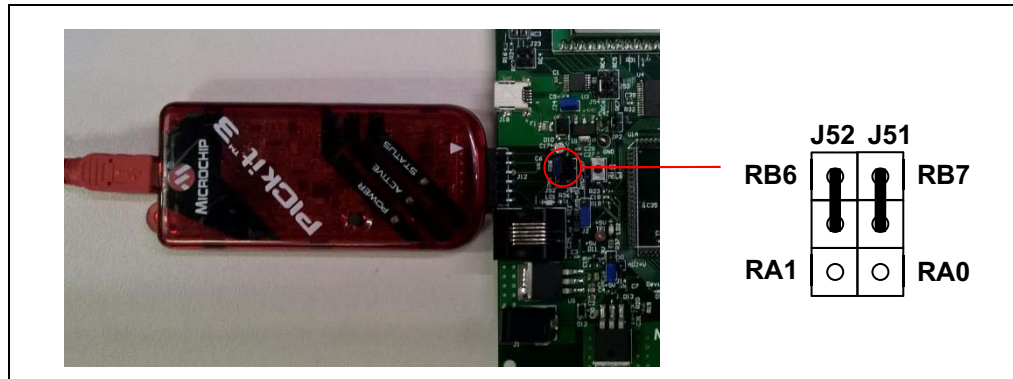
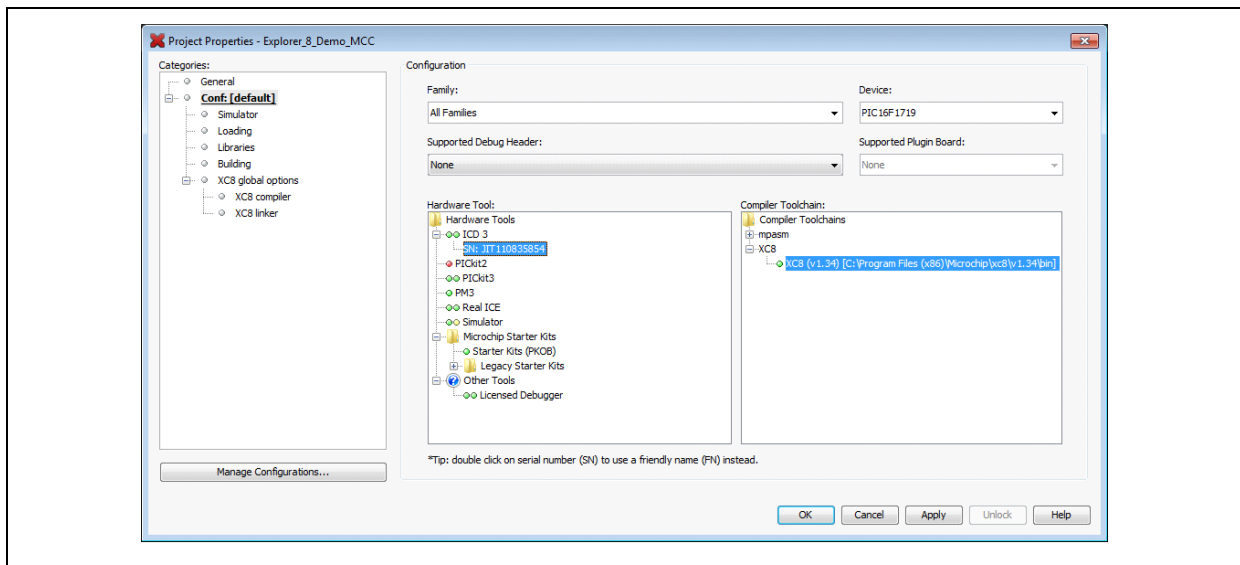

FIGURE 2-3: PICKit™ 3 CONNECTION AND JUMPER CONFIGURATION



Explorer 8 Development Board User's Guide

FIGURE 2-4: PROJECT PROPERTIES WINDOW IN MPLAB® X IDE



6. Select the XC8 compiler under the Compiler Tool chain, if not already selected.
7. Under Hardware Tool, click **ICD 3**, **REAL ICE** or **PICKit 3**, depending upon the connected programmer.
8. Click **Apply**, and then **OK**.
9. To load the program to the PIC16F1719 device, click the **Make and Program Device** icon.



2.4 CONNECTING TO HOST PC FOR USB COMMUNICATION

The Explorer 8 Development Board allows the device to communicate with a PC via two interfaces: USB-to-UART and USB-to-I²C. An on-board USB 2.0 to I²C/UART Protocol Converter (MCP2221) is provided for this purpose. The MCP2221 supports Windows® (XP and later versions), Linux® and Mac OS® (all versions) operating systems. Drivers can be downloaded from the Microchip web site at www.microchip.com/mcp2221.

After installing the MCP2221 driver, the board can now be connected to the host PC through a USB cable provided in the Explorer 8 Development Board kit.

2.4.1 USB-to-UART Interface

The MCP2221 supports baud rates between 300 and 115200. It utilizes a set of commands to read and set the UART parameters during operation. It only supports eight Data bits, no Parity, and one Stop bit. The terminal program (e.g., Teraterm, Realterm, etc.) must be configured with the same settings.

If the MCU is configured to communicate with the host PC via UART interface, jumpers J53, J54, J55 and J56 must be setup properly. The tutorial program in the PIC16F1719 implements the UART for MCU-to-PC communication. [Figure 2-5](#) shows how to setup the jumpers for the tutorial program. The MCU is configured for Transmit mode so only J54 is utilized and the other jumpers are left disconnected.

FIGURE 2-5: SETUP FOR UART TRANSMIT MODE

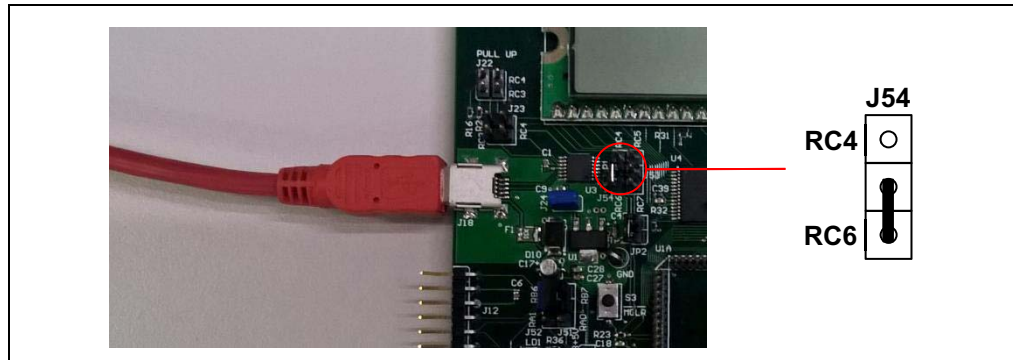

The operating system searches for a driver once the Explorer 8 Development Board is connected to the PC using the USB-to-UART interface. After a suitable driver is found, the system creates an entry in the registry. The entry stores relevant information about the USB-to-UART adapter, its driver and the associated COM port.

2.4.2 USB-to-I²C Interface

For the USB-to-I²C interface, the MCP2221 functions as an I²C Master to the PIC MCU and uses USB HID (Human Interface Device) protocol for communication with a host PC. A typical command exchange starts with a 64-byte packet that is written by the host PC. Afterward, the PC reads the response USB-to-I²C from the device as a 64-byte packet.

To use the Explorer 8 Development Board for I²C interface, jumpers J22, J23, J57 and J58 must be configured properly. See Labels 1, 2 and 3 of [Table 1-1](#) for sample jumper configurations.

Explorer 8 Development Board User's Guide

2.5 POWERING THE BOARD

The Explorer 8 Development Board can be powered-up in two ways: External 9V DC supply and USB power.

2.5.1 External 9V Power Supply

To power-up the board using an external 9V power supply:

- Plug the 9V power supply to a wall outlet.
- Connect the 9V power supply to the board through the barrel connector placed on the lower left corner of the board.
- Place J2 in the position shown in [Figure 2-6](#).

FIGURE 2-6: USING THE 9V EXTERNAL SUPPLY

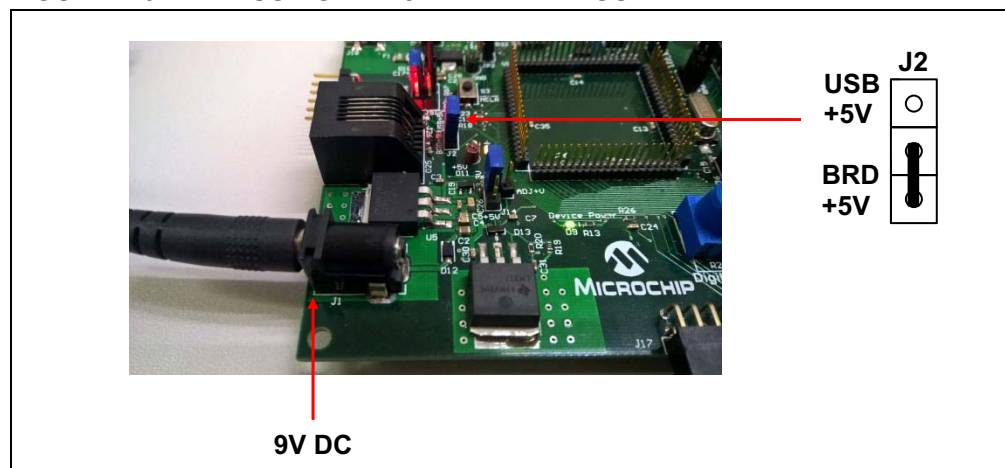

One of the on-board regulators will reduce this voltage to 5V which can be measured through Test Points TP1 and TP7. For 3.3V, the 5V output will be further reduced through a 3.3V regulator. Make sure to attach J24 before measuring the 3.3V output at TP6. The board also supports other voltage values through an adjustable voltage regulator. The variable voltage can be measured through TP5. For more details on varying the voltage values, see [Section 2.6 “Selecting Vdd Values”](#).

2.5.2 USB Power

The Explorer 8 Development Board can also be powered through USB. The board will draw +5V power from a host device such as a PC by connecting a USB cable between the on-board micro USB socket and the PC's USB port. The micro USB cable is included in the Explorer 8 Development Kit.

[Figure 2-7](#) shows how to connect the USB cable to the micro USB socket and J2 setting for USB-powered configuration.

FIGURE 2-7: USB-POWERED BOARD CONFIGURATION

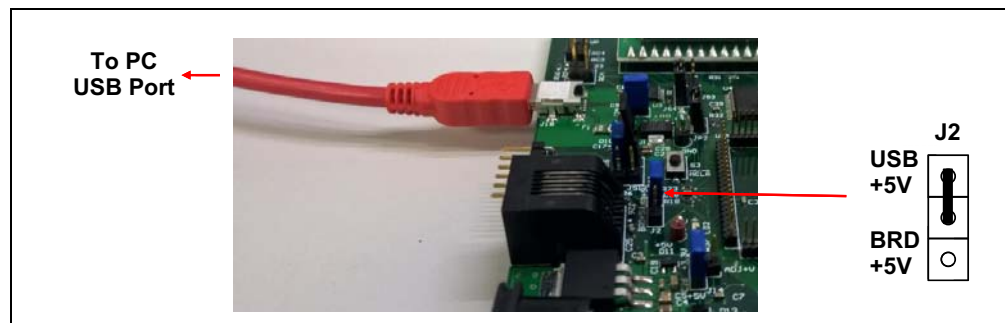

2.6 SELECTING V_{DD} VALUES

The Explorer 8 Development Board is capable of supplying 5V, 3.3V and variable supply voltages between 1.2 and 5V through dedicated on-board regulators. The variable supply voltage, called V_{VAR} (also equal to V_{DD}), is used to power the device and the on-board components.

2.6.1 Varying the Device Voltage

Figure 2-8 shows the jumper configuration for the three voltage settings.

FIGURE 2-8: JUMPER CONFIGURATION FOR DIFFERENT DEVICE VOLTAGES

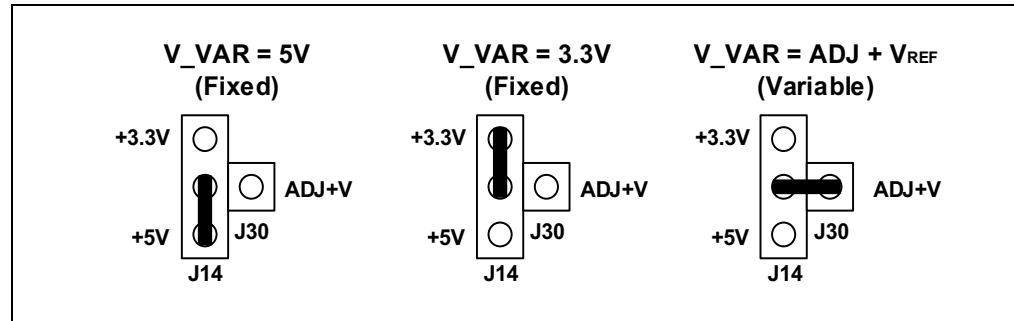

2.6.2 Calculating other V_{DD} Values

For voltages other than 5V and 3.3V, jumpers J14 and J30 must be configured for variable supply as shown in Figure 2-8. Other V_{DD} values can be produced by the LM317 adjustable voltage regulator by populating the PIM board's R101 and R102 with different value resistors. This section discusses how to calculate alternate values for these resistors. For detailed information, see the LM317 data sheet.

Note: R101 and R102 are named R1 and R2, respectively, in other PIM boards. These must not be confused with the R1 and R2 values discussed in this section.

EQUATION 2-1: LM317 REGULATOR VOLTAGE OUTPUT

$$V_{OUT} = V_{REF} \left(1 + \frac{R2}{R1} \right) + I_{ADJ} \cdot R2$$

I_{ADJ} is minimized by the LM317 and can be neglected or assumed to be zero. V_{REF} is the reference voltage developed by the LM317 between the output and adjustment terminal, and is typically equal to 1.25V.

Therefore, the equation can be rewritten as shown in Equation 2-2.

EQUATION 2-2: CALCULATING THE LM317 OUTPUT VOLTAGE

$$V_{OUT} = 1.25V \left(1 + \frac{R2}{R1} \right)$$

Where:

$$R2 = R20 \parallel R102 = \frac{R20 \cdot R102}{R20 + R102}$$

$$R1 = R19 \parallel R101 = \frac{R19 \cdot R101}{R19 + R101}$$

Explorer 8 Development Board User's Guide

The Explorer 8 Development Board's R20 and R19 resistors have their default values of 1 k Ω and 330 Ω , respectively. Without R102 and R101 being inserted in parallel on the PIM board, $V_{OUT} = 1.25V(1 + 1 \text{ k}\Omega/330\Omega) = 5.04V$.

To calculate a desired V_{OUT} :

1. Solve for R2, given $R1 = R19 = 330\Omega$.
2. Now knowing R2 and R20, solve for R102.
3. Determine the nearest available resistor value for R102 and recalculate the resulting V_{VAR} to make sure it does not exceed the maximum V_{DD} for the part being used.

For devices that are not mounted on a PIM but need a supply voltage other than 5V or 3.3V, external resistors may be connected to the ADJ pin of J29. A resistor connected between ADJ and ground is equivalent to R102 and a resistor connected between ADJ and V_{VAR} is equivalent to R101. Calculate the resistor values using the equations previously discussed in this section.

Chapter 3. Tutorial Program

The tutorial program is pre-programmed into the PIC16F1719 that comes with the Explorer 8 demo board. This program, which can be downloaded from the Microchip web site (www.microchip.com/explorer8), is built using the MPLAB X IDE and the MPLAB XC8 Compiler. It also utilizes the macros, drivers and initializers generated by the MPLAB® Code Configurator (MCC). MCC is a plug-in for MPLAB X IDE that generates seamless, easy to understand drivers and initializers that are inserted into your project. For more information on MCC, visit www.microchip.com/mcc.

3.1 TUTORIAL PROGRAM OPERATION

The tutorial program consists of three components: Voltmeter, LED Toggle and LED dimming. The flowchart in [Figure 3-1](#) illustrates the button navigation through the entire program.

The different components are displayed on the LCD and the LEDs. The data sent to the LCD is simultaneously transmitted by the EUSART module of the device to the USB-to-UART/I²C converter and can, therefore, be viewed on the host PC monitor through a serial terminal program (see [Section 2.4 “Connecting to Host PC for USB Communication”](#)). Make sure that the terminal program is configured to 9600 Baud, 8-bit Data, No Parity and 1 Stop Bit. For the board supply and jumper configurations, see [Section 2.1 “Explorer 8 with Pre-Programmed Device”](#).

FIGURE 3-1: TUTORIAL PROGRAM FLOWCHART

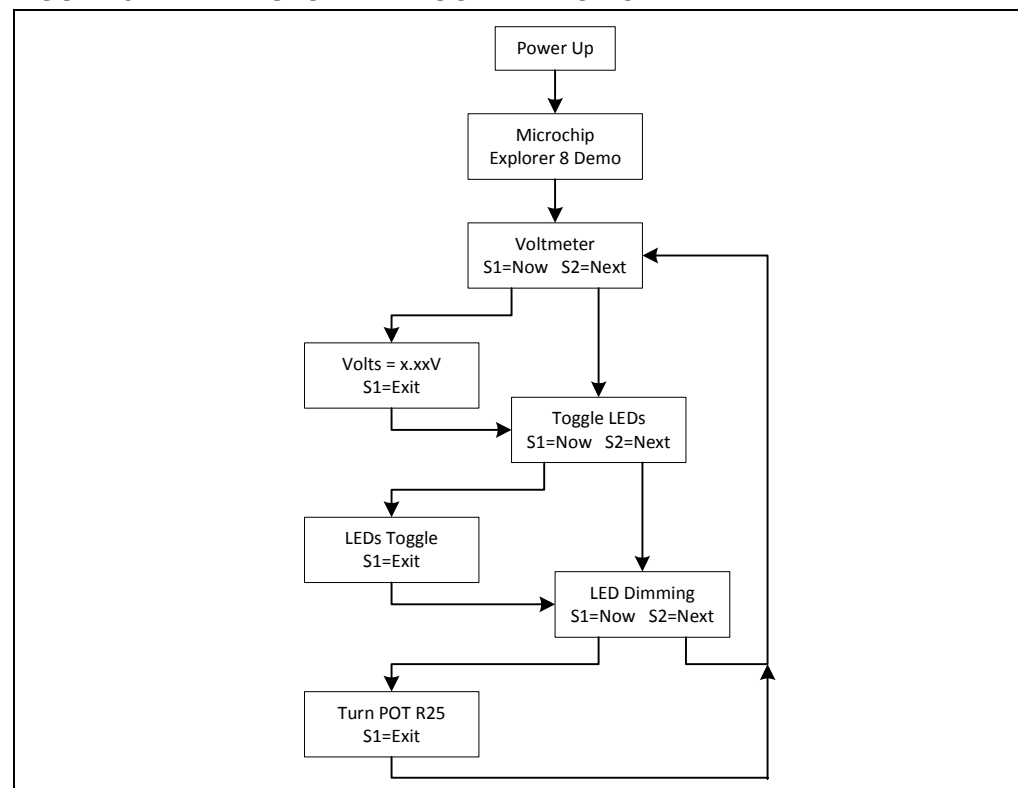

Explorer 8 Development Board User's Guide

To select menu options, use the S1 and S2 buttons on the board (see [Figure 3-2](#)).

FIGURE 3-2: BUTTON SWITCHES FOR MENU SELECTION

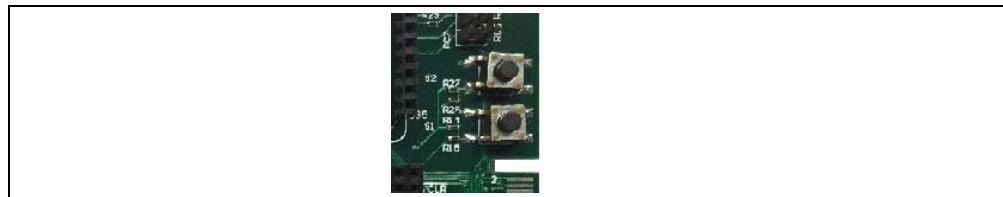

When the board is powered up, a “Microchip Explorer 8 Demo” text is displayed on the LCD and sent to the serial terminal as well. After a few seconds, the program proceeds to the first component.

1. Voltmeter

This mode uses the Analog-to-Digital Converter (ADC) module to measure the voltage across the R25 potentiometer and display a value between 0.00V and 5.00V on the LCD. (In general, the displayed value is between 0.00V to V_VAR).

FIGURE 3-3: VOLTMETER DISPLAY AND COMPONENT

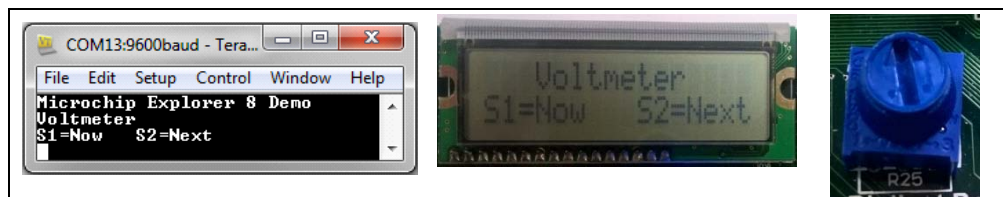

The voltage reading is updated continuously until the mode is exited by pressing S1.

FIGURE 3-4: VOLTAGE DISPLAY

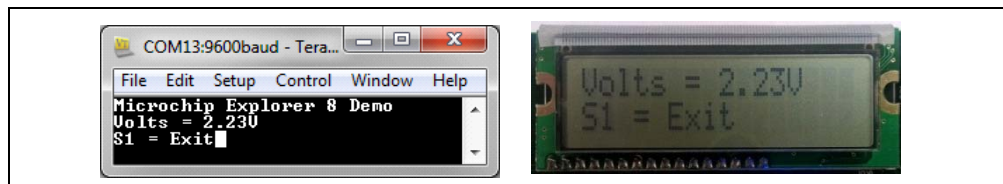

2. LEDs Toggle

This mode toggles LEDs D1 and D2 alternately with D3 and D4 between fully On and fully Off states every 100 milliseconds.

FIGURE 3-5: LED TOGGLE DISPLAY

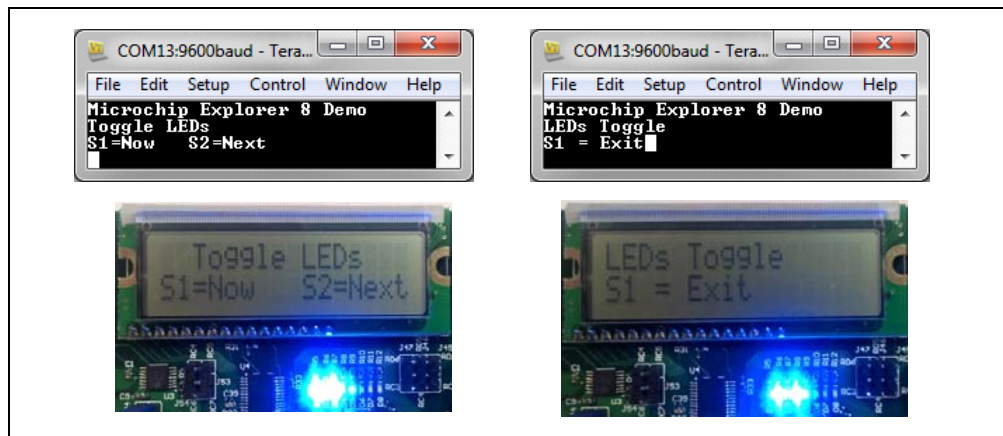

3. LED Dimming

Both the Complementary Output Generator (COG) and Analog-to-Digital Converter (ADC) modules are implemented in this mode. The COG produces a pulse-width modulated output whose duty cycle is determined by the measured ADC value across the R25 potentiometer. The COG output controls the brightness of the D6, D7 and D8 LEDs.

FIGURE 3-6: LED DIMMING DISPLAY

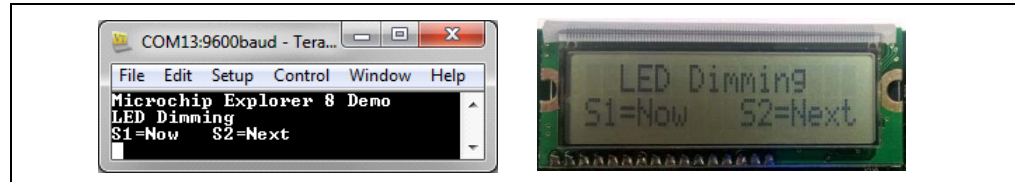

Turning the potentiometer clockwise increases the brightness of the LEDs while rotating it counterclockwise dims the LEDs.

FIGURE 3-7: LED DIMMING

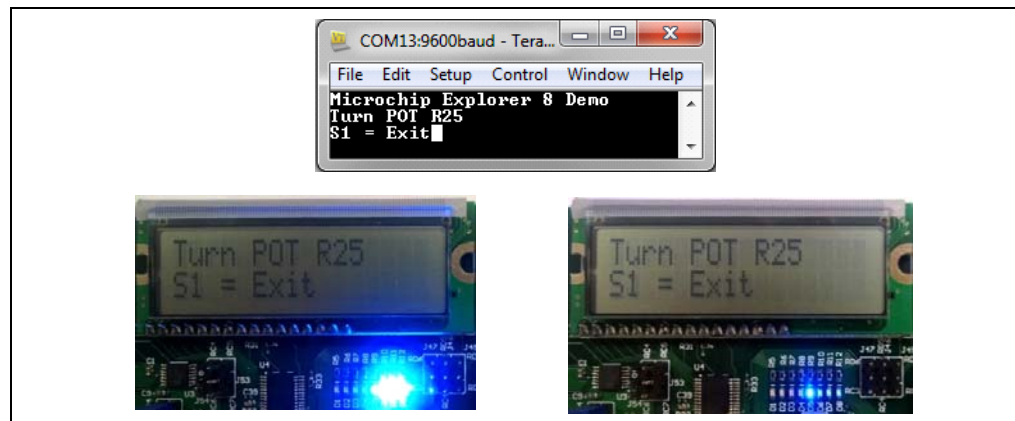

Exiting this mode by pressing S1 brings the program back to Voltmeter.

3.2 SOURCE CODE AND DATA SHEETS

The tutorial program is available on the Microchip web site:

(www.microchip.com/explorer8)

The source codes and hex files are contained in the Explorer_8_Demo_MCC.X project file.

For information on reprogramming the device with new or modified code, see [Section 2.3 “Programming the Microcontrollers”](#).

Explorer 8 Development Board User's Guide

NOTES:

Appendix A. Hardware Details

A.1 HARDWARE ELEMENTS

A.1.1 Processor Sockets

The Explorer 8 Development Board contains four processor sockets:

- 20-pin Socket – for 8/14/20-pin DIP microcontrollers
- 28-pin Socket – for 28-pin DIP microcontrollers
- 40-pin Socket – for 40-pin DIP microcontrollers
- 84-pin PIM Socket – for 44/64/80-pin PIM-mounted microcontrollers

Only one device may be used at a time. Remove unnecessary devices before demonstrating your program.

For a complete list of 8-bit PIC microcontrollers and available PIMs, go to the Microchip web site at www.microchip.com.

A.1.2 Display

Eight blue LEDs (D8:D1) are connected to the <RB3:RB0> and <RD3:RD0> pins of each processor type, respectively. These pins are set high to light the LEDs.

LEDs D8:D5 may be disconnected by removing jumper J21 while LEDs D4:D1 may be disconnected by removing J7.

D5 lights up once J21 is attached because RB0 is also connected to switch SW1 and this pin is always pulled up to V_VAR.

A.1.3 Power Supply

The Explorer 8 Development Board does not come with a power supply but it comes with a micro USB cable for powering the board via USB. Using USB power, however, limits the supply to only 100 mA. Using the 9V external supply, both 3.3V and 5.0 supplies are capable of up to 1A. Microchip's 9V, 1.3A power supply (Part Number AC002014) can be used if external supply is needed. When using an external supply, the board is limited to a maximum of 5A, imposed on the breadboard contacts.

The board is populated with two fixed (U5 and U1) and one variable (U2) voltage regulators to provide 5.0V, 3.3V and any voltage between 1.2V and 5V.

Note: For power supply selection, see [Section 2.5 “Powering the Board”](#) and [Section 2.6 “Selecting Vdd Values”](#).

Explorer 8 Development Board User's Guide

A.1.4 Micro USB Port

A micro USB port is provided not just for powering the board but also for communications between the device and a host PC via USB. The micro USB cable included in the Explorer 8 Development Board Kit can be used to connect the board's micro USB port to the host PC's USB port.

The on-board MCP2221 is a USB-to-UART/I²C serial converter that enables USB connectivity for devices with UART or I²C interfaces.

Note: For details on this connection, see [Section 2.4 “Connecting to Host PC for USB Communication”](#).

A.1.5 Switches

Three switches are provided on the board:

- S1 – Active-low switch connected to RB0
- S2 – Active-low switch connected to RA5
- S3 – $\overline{\text{MCLR}}$ to hard reset the processor

When pressed, the switches are grounded. When idle, they are pulled high (V_{VAR}).

A.1.6 Oscillator Options

An 8 MHz crystal (Y1) serves as the controller's primary oscillator. It can also be used as TMR0's clock source for some devices depending upon the configured J36 and J37 settings.

A.1.7 Analog Input (Potentiometer)

A 10 k Ω potentiometer (R25) is connected through a series resistor to RA0/AN0.

The potentiometer can be adjusted from V_{VAR} to GND to provide an analog input to one of the device ADC channels.

A.1.8 ICD Connector

The MPLAB[®] ICD 3 can be connected to the modular connector (J26) for programming and in-circuit debugging. Jumpers J51 and J52 define the connection of the in-circuit debugger to the device pins. The MPLAB REAL ICE can also be connected to this interface.

Note: For details, see Section [Section 2.3.3 “Programming the Microcontroller”](#).

A.1.9 PICKit™ Connector

A PICKit 3 In-Circuit Debugger/Programmer can be connected to the 6-pin interface provided by J12. Jumpers J51 and J52 define the connection of the PICKit3 to the microcontroller pins.

Note: For details, see [Section 2.4 “Connecting to Host PC for USB Communication”](#).

A.1.10 PICtail™ and PICtail Plus Expansion Connectors

The PICtail interface enables the Explorer 8 Development Board to be connected directly to available PICtail daughter board cards. The following female headers are available to support different PIC microcontroller connections to PICtail daughter cards and for user access to MCU pins:

- 2x14 Socket (J3) – to support 8/14/18/20/28-pin devices
- 2x6 Socket (J11) – to support up to 44-pin devices
- 2x10 Socket (J5) – to support up to 68-pin devices
- 2x8 Socket (J28) – to support up to 80-pin devices

The PICtail Plus connectors (J19) are the card-edge modular connector found on the right part of the board. It is based on a 120-pin connection divided into three sections of 30 pins, 30 pins and 56 pins. Each 30-pin section provides connections to all of the serial communication peripherals, as well as many I/O ports, external interrupts and ADC channels. This provides enough signals to develop many different expansion interfaces for different PICtail daughter cards.

For available PICtail daughter cards, visit the Microchip web site at www.microchip.com.

A.1.11 mikroBUS™ Connectors

Two MikroElektronika Click boards may be loaded into the sockets J32 or J35. Various communication ports and interfaces are controlled by Jumpers J41 through J50. Power and ground for the Click boards is supplied through the existing connections to the sockets.

Note: Sample jumper configurations are provided in [Table 1-1](#).

A.1.12 Pmod™ Connectors

Two Digilent Pmod interfaces are available on the bottom middle of the Explorer 8 Development Board. Both sockets are the 12-pin version of the Digilent Pmod and provide eight I/O signal pins, two power pins and two ground pins. The signals are arranged so that they provide two of the 6-pin interfaces stacked.

Note: Sample jumper configurations are provided in [Table 1-1](#).

A.1.13 Configurable In-line Connector

A 20-pin single in-line socket (J33) is provided for connection with expansion boards. The socket is connected in parallel to the first line of a 2x20 female header (J25) making it a configurable in-line connector. The second line of J25 has each of its pin socket connected to the 3.3V supply while another 2x20 female header (J39) makes each of its pin socket available with 5V.

A.1.14 LCD

An LCD with two lines, 16 characters each, is connected to the SPI I/O expander, MCP23S17. The two control lines and eight data lines are connected to the I/O expander. The I/O expander has an SPI interface that connects it to the microcontroller. The LCD is disabled or enabled through jumper J61.

Explorer 8 Development Board User's Guide

A.1.15 Sample Devices

A sample part programmed with a simple program is included in the Explorer 8 Development Board Kit. The device's I/O features and port connections are listed in [Table A-1](#).

TABLE A-1: SAMPLE DEVICE I/O FEATURES AND CONNECTIONS

Device	LEDs	USB	S1	S2	S3	LCD	POT R25	ICD/ PICKit™	Y1
PIC16F1719	RB3:RB0 RD3:RD0	RC6	RB0	RA5	$\overline{\text{MCLR}}$	RC3 RC5 RA2 RB5	RA0	RB7 RB6	RA7 RA6

A.2 BOARD LAYOUT AND SCHEMATICS

FIGURE A-1: EXPLORER 8 DEVELOPMENT BOARD

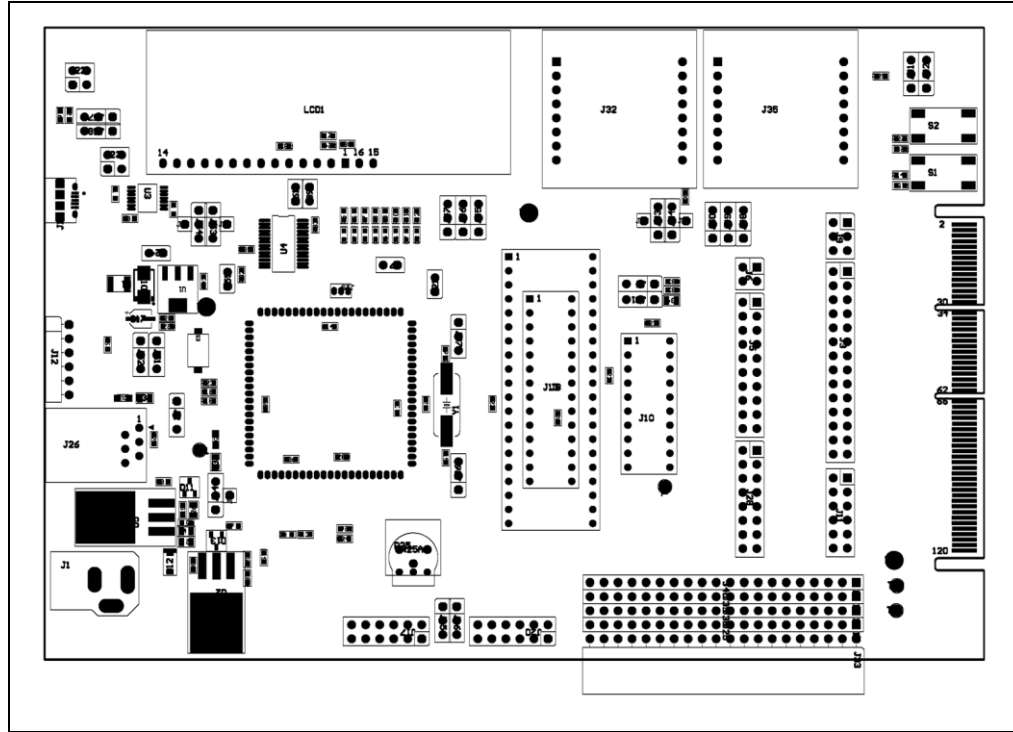

FIGURE A-2: EXPLORER 8 DEVELOPMENT SCHEMATIC - 1

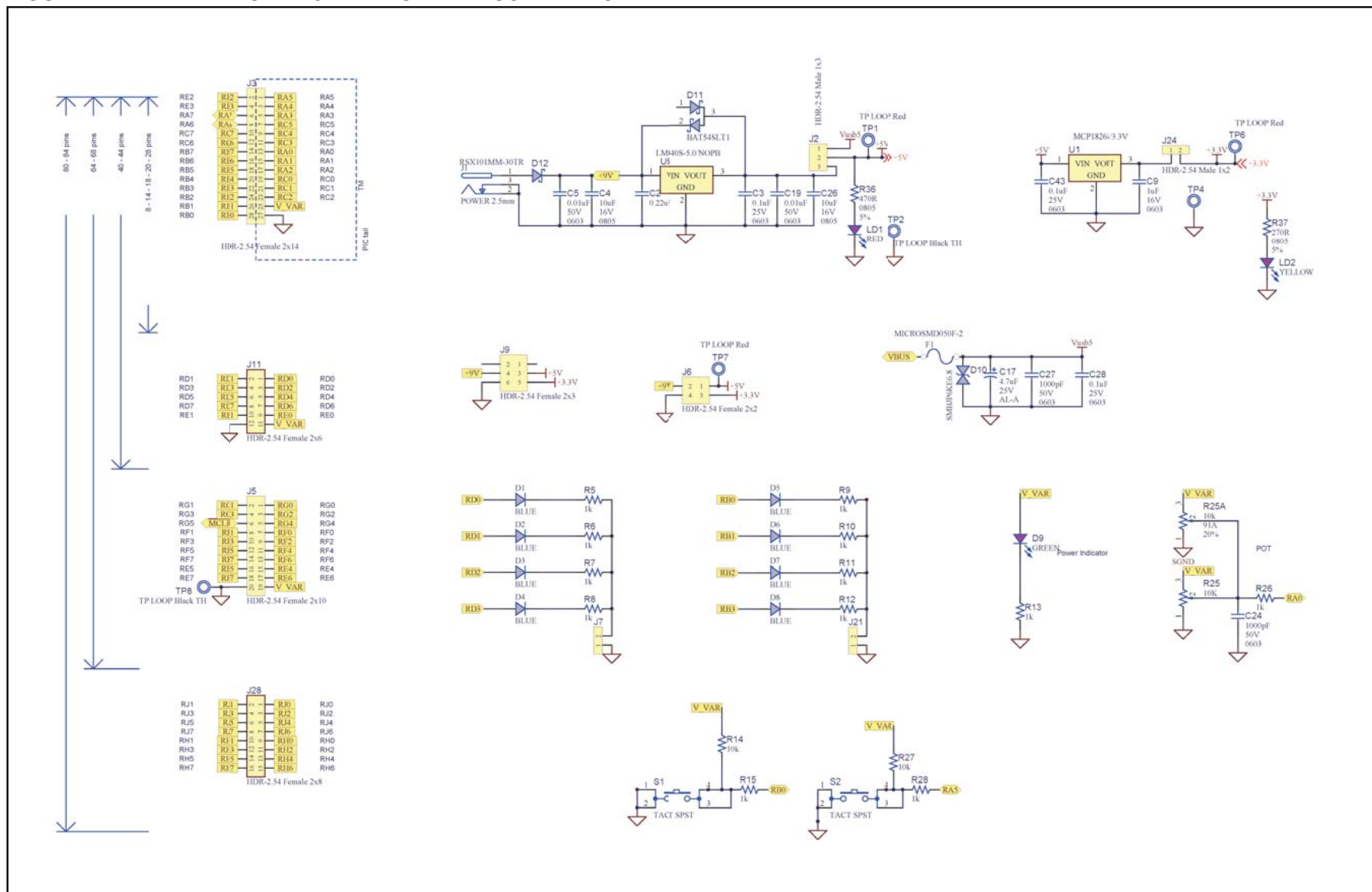
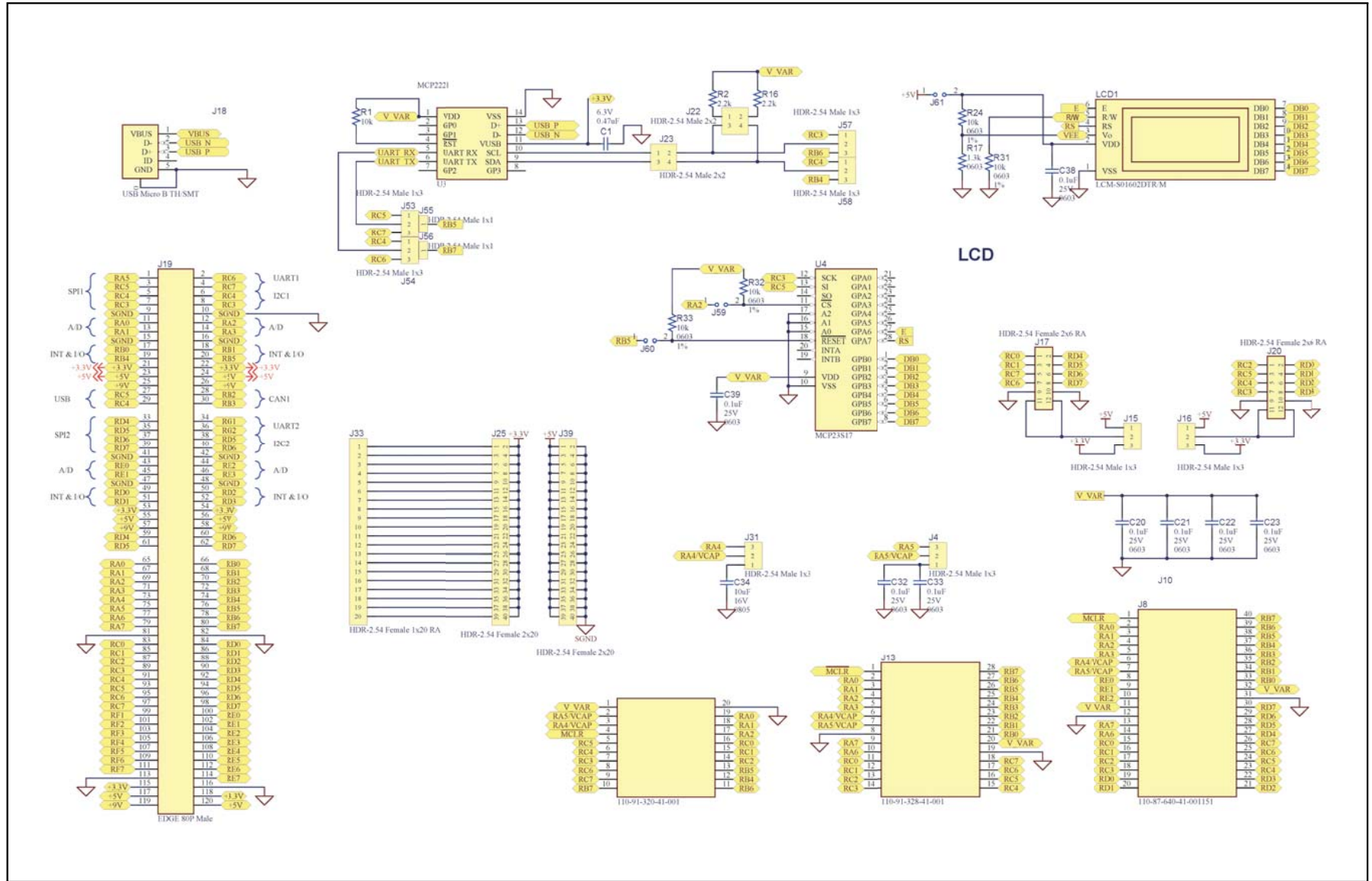

FIGURE A-4: EXPLORER 8 DEVELOPMENT SCHEMATIC - 3





MICROCHIP

Worldwide Sales and Service

AMERICAS

Corporate Office
2355 West Chandler Blvd.
Chandler, AZ 85224-6199
Tel: 480-792-7200
Fax: 480-792-7277
Technical Support:
<http://www.microchip.com/support>
Web Address:
www.microchip.com

Atlanta
Duluth, GA
Tel: 678-957-9614
Fax: 678-957-1455

Austin, TX
Tel: 512-257-3370

Boston
Westborough, MA
Tel: 774-760-0087
Fax: 774-760-0088

Chicago
Itasca, IL
Tel: 630-285-0071
Fax: 630-285-0075

Cleveland
Independence, OH
Tel: 216-447-0464
Fax: 216-447-0643

Dallas
Addison, TX
Tel: 972-818-7423
Fax: 972-818-2924

Detroit
Novi, MI
Tel: 248-848-4000

Houston, TX
Tel: 281-894-5983

Indianapolis
Noblesville, IN
Tel: 317-773-8323
Fax: 317-773-5453

Los Angeles
Mission Viejo, CA
Tel: 949-462-9523
Fax: 949-462-9608

New York, NY
Tel: 631-435-6000

San Jose, CA
Tel: 408-735-9110

Canada - Toronto
Tel: 905-673-0699
Fax: 905-673-6509

ASIA/PACIFIC

Asia Pacific Office
Suites 3707-14, 37th Floor
Tower 6, The Gateway
Harbour City, Kowloon

Hong Kong
Tel: 852-2943-5100
Fax: 852-2401-3431

Australia - Sydney
Tel: 61-2-9868-6733
Fax: 61-2-9868-6755

China - Beijing
Tel: 86-10-8569-7000
Fax: 86-10-8528-2104

China - Chengdu
Tel: 86-28-8665-5511
Fax: 86-28-8665-7889

China - Chongqing
Tel: 86-23-8980-9588
Fax: 86-23-8980-9500

China - Dongguan
Tel: 86-769-8702-9880

China - Hangzhou
Tel: 86-571-8792-8115
Fax: 86-571-8792-8116

China - Hong Kong SAR
Tel: 852-2943-5100
Fax: 852-2401-3431

China - Nanjing
Tel: 86-25-8473-2460
Fax: 86-25-8473-2470

China - Qingdao
Tel: 86-532-8502-7355
Fax: 86-532-8502-7205

China - Shanghai
Tel: 86-21-5407-5533
Fax: 86-21-5407-5066

China - Shenyang
Tel: 86-24-2334-2829
Fax: 86-24-2334-2393

China - Shenzhen
Tel: 86-755-8864-2200
Fax: 86-755-8203-1760

China - Wuhan
Tel: 86-27-5980-5300
Fax: 86-27-5980-5118

China - Xian
Tel: 86-29-8833-7252
Fax: 86-29-8833-7256

ASIA/PACIFIC

China - Xiamen
Tel: 86-592-2388138
Fax: 86-592-2388130

China - Zhuhai
Tel: 86-756-3210040
Fax: 86-756-3210049

India - Bangalore
Tel: 91-80-3090-4444
Fax: 91-80-3090-4123

India - New Delhi
Tel: 91-11-4160-8631
Fax: 91-11-4160-8632

India - Pune
Tel: 91-20-3019-1500

Japan - Osaka
Tel: 81-6-6152-7160
Fax: 81-6-6152-9310

Japan - Tokyo
Tel: 81-3-6880-3770
Fax: 81-3-6880-3771

Korea - Daegu
Tel: 82-53-744-4301
Fax: 82-53-744-4302

Korea - Seoul
Tel: 82-2-554-7200
Fax: 82-2-558-5932 or
82-2-558-5934

Malaysia - Kuala Lumpur
Tel: 60-3-6201-9857
Fax: 60-3-6201-9859

Malaysia - Penang
Tel: 60-4-227-8870
Fax: 60-4-227-4068

Philippines - Manila
Tel: 63-2-634-9065
Fax: 63-2-634-9069

Singapore
Tel: 65-6334-8870
Fax: 65-6334-8850

Taiwan - Hsin Chu
Tel: 886-3-5778-366
Fax: 886-3-5770-955

Taiwan - Kaohsiung
Tel: 886-7-213-7828

Taiwan - Taipei
Tel: 886-2-2508-8600
Fax: 886-2-2508-0102

Thailand - Bangkok
Tel: 66-2-694-1351
Fax: 66-2-694-1350

EUROPE

Austria - Wels
Tel: 43-7242-2244-39
Fax: 43-7242-2244-393

Denmark - Copenhagen
Tel: 45-4450-2828
Fax: 45-4485-2829

France - Paris
Tel: 33-1-69-53-63-20
Fax: 33-1-69-30-90-79

Germany - Dusseldorf
Tel: 49-2129-3766400

Germany - Karlsruhe
Tel: 49-721-625370

Germany - Munich
Tel: 49-89-627-144-0
Fax: 49-89-627-144-44

Italy - Milan
Tel: 39-0331-742611
Fax: 39-0331-466781

Italy - Venice
Tel: 39-049-7625286

Netherlands - Drunen
Tel: 31-416-690399
Fax: 31-416-690340

Poland - Warsaw
Tel: 48-22-3325737
Fax: 31-416-690340

Spain - Madrid
Tel: 34-91-708-08-90
Fax: 34-91-708-08-91

Sweden - Stockholm
Tel: 46-8-5090-4654

UK - Wokingham
Tel: 44-118-921-5800
Fax: 44-118-921-5820

07/14/15