

# PART OBSOLETE - EOL18

Bulletin I2719 rev. F 11/02

International  
**IR** Rectifier

## 8GBU Series

### 8.0 Amps Single Phase Full Wave

### Bridge Rectifier

#### Features

- Diode chips are glass passivated
- Suitable for Universal hole mounting
- Easy to assemble & install on P.C.B.
- High Surge Current Capability
- High Isolation between terminals and molded case ( $1500 V_{RMS}$ )
- Lead free terminals solderable as per MIL-STD-750 Method 2026
- Terminals suitable for high temperature soldering at  $260^{\circ}\text{C}$  for 8-10 secs
- UL E160375 approved

$$I_{O(AV)} = 8A$$
$$V_{RRM} = 50/ 1200V$$

#### Description

These GBU Series of Single Phase Bridges consist of four glass passivated silicon junction connected as a Full Wave Bridge. These four junctions are encapsulated by plastic molding technique. These Bridges are mainly used in Switch Mode power supply and in industrial and consumer equipment.

#### Major Ratings and Characteristics

Parameters	8GBU	Units
$I_O$	8	A
@ $T_C$	100	$^{\circ}\text{C}$
$I_{FSM}$ @50Hz	200	A
@60Hz	210	A
$I^2t$ @50Hz	200	$\text{A}^2\text{s}$
@60Hz	184	$\text{A}^2\text{s}$
$V_{RRM}$ range	50 to 1200	V
$T_J$	- 55 to 150	$^{\circ}\text{C}$

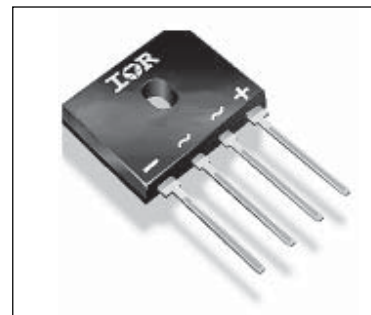

8GBU

**ELECTRICAL SPECIFICATIONS**

Voltage Ratings

Type number	Voltage Code V	$V_{RRM}$ , max repetitive peak rev. voltage $T_J = T_{J,max}$ V	$V_{RSM}$ , max non-repetitive peak rev. voltage $T_J = T_{J,max}$ V	$V_{RMS}$ , max RMS voltage $T_J = T_{J,max}$ V	$I_{RRM}$ max. @ rated $V_{RRM}$ $T_J = 25^\circ\text{C}$ $\mu\text{A}$	$I_{RRM}$ max. @ rated $V_{RRM}$ $T_J = 150^\circ\text{C}$ $\mu\text{A}$
8GBU	005	50	80	35	5	400
	01	100	150	70	5	400
	02	200	300	140	5	400
	04	400	500	280	5	400
	06	600	725	420	5	400
	08	800	900	560	5	400
	10	1000	1100	700	5	400
	12	1200	1300	850	5	400

**Forward Conduction**

Parameters	8GBU	Unit	Conditions
$I_O$ Maximum DC output current	8.0	A	$T_C = 100^\circ\text{C}$ , Resistive & inductive load $T_C = 100^\circ\text{C}$ , Capacitive load
	6.4		
$I_{FSM}$ Maximum peak, one-cycle non-repetitive surge current, following any rated load condition and with rated $V_{RRM}$ reapplied	200		$t = 10\text{ms}$
	210		$t = 8.3\text{ms}$
$I^2t$ Maximum $I^2t$ for fusing, initial $T_J = T_{J,max}$	200	$\text{A}^2\text{s}$	$t = 10\text{ms}$
	184		$t = 8.3\text{ms}$
$V_{FM}$ Maximum peak forward voltage per diode	1.0	V	$T_J = 25^\circ\text{C}$ , $I_{FM} = 8\text{A}$
$I_{RM}$ Typical peak reverse leakage current t per diode	5.0	$\mu\text{A}$	$T_J = 25^\circ\text{C}$ , 100% $V_{RRM}$ $T_J = 150^\circ\text{C}$ , 100% $V_{RRM}$
	400		
$V_{RRM}$ Maximum repetitive peak reverse voltage range	50 to 1200	V	

**Thermal and Mechanical Specifications**

Parameters	8GBU	Unit	Conditions
$T_J$ Operating and storage temperature range	-55 to 150	$^\circ\text{C}$	
$R_{thJC}$ Max. thermal resistance junction to case	2.2	$^\circ\text{C}/\text{W}$	DC rated current through bridge (1)
$R_{thJA}$ Thermal resistance, junction to ambient	21	$^\circ\text{C}/\text{W}$	DC rated current through bridge (1)
W Approximate weight	4 (0.14)	g (oz)	
T Mounting Torque	1.0	Nm	Bridge to Heatsink
	9.0	Lb.in	

Note (1): Bridge mounted on Aluminum heat sink of dim 82x82x3.0mm, use silicon thermal compound heat transfer and bolt down using 3mm screw

**Ordering Information Table**

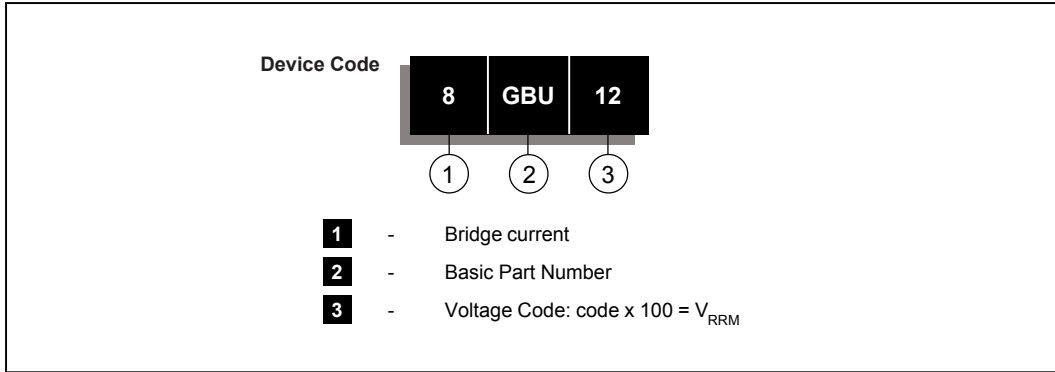

**Outline Table**

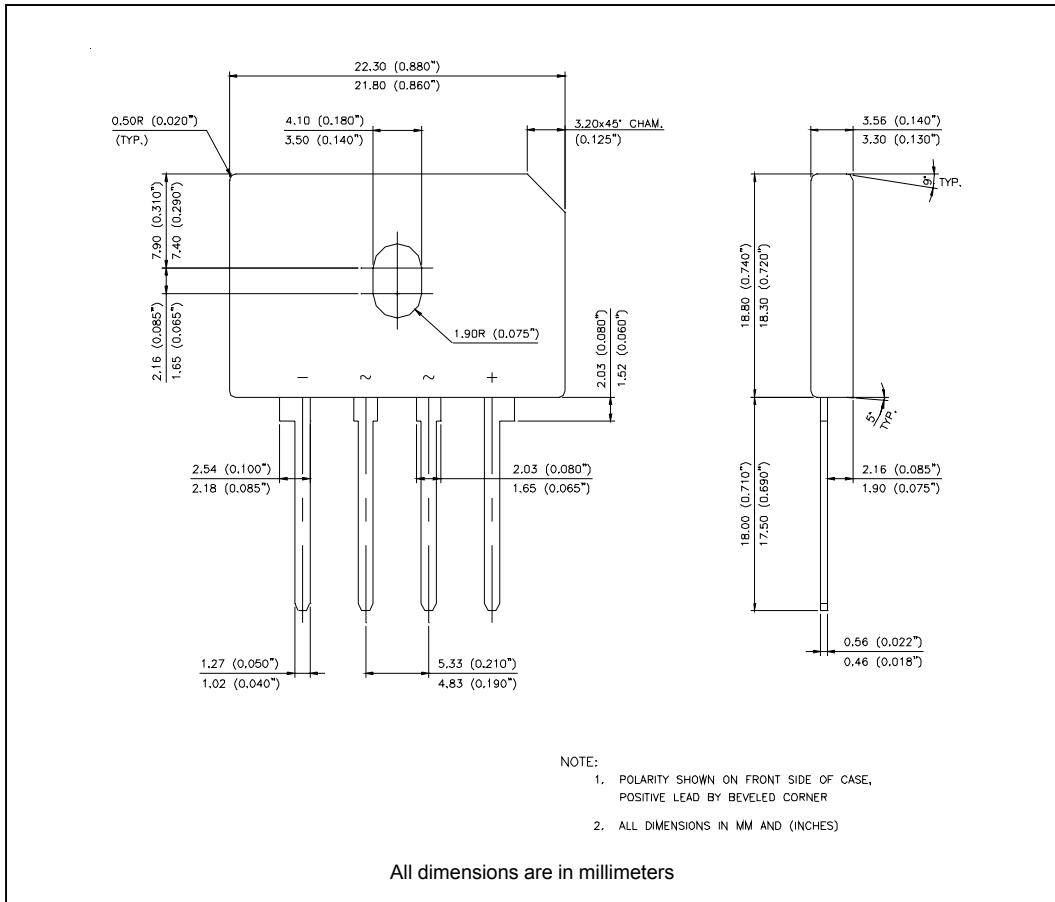

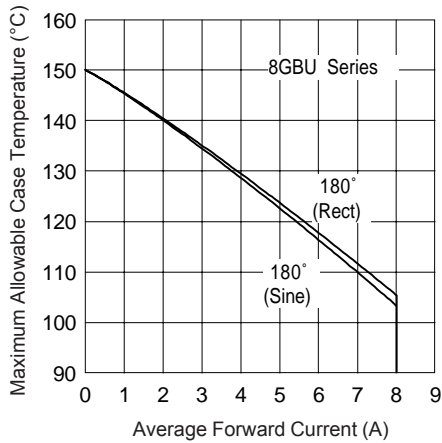

Fig. 1 - Current Ratings Characteristics

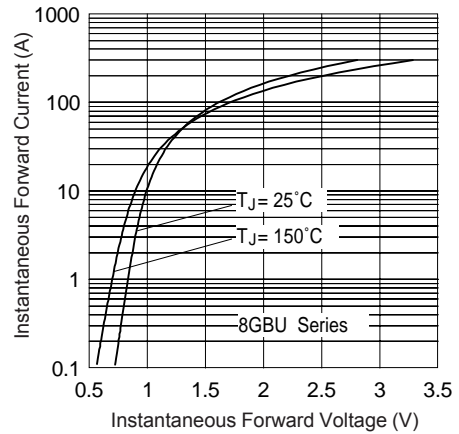

Fig. 2 - Forward Voltage Drop Characteristics

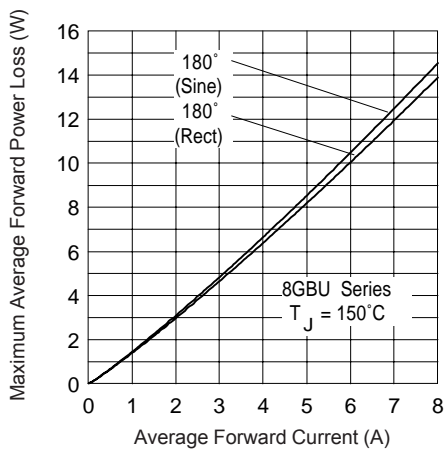

Fig. 3 - Total Power Loss Characteristics

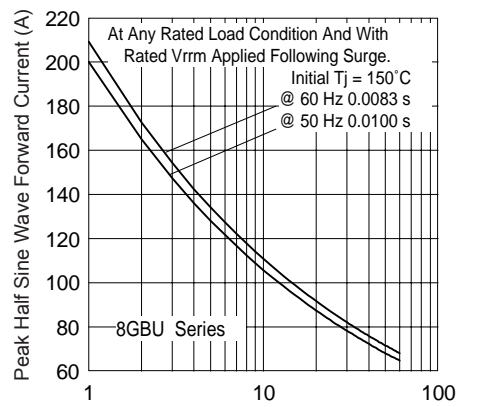

Fig. 4 - Maximum Non-Repetitive Surge Current

Data and specifications subject to change without notice.  
This product has been designed and qualified for Multiple Level.  
Qualification Standards can be found on IR's Web site.

International  
**IR** Rectifier

**IR WORLD HEADQUARTERS:** 233 Kansas St., El Segundo, California 90245, USA Tel: (310) 252-7105  
TAC Fax: (310) 252-7309  
Visit us at [www.irf.com](http://www.irf.com) for sales contact information. 11/02