

INTRODUCTION:

Adam Tech right angle PCB mount .318" footprint D-Sub connectors are a popular interface for many I/O applications. Offered in 9, 15, 25 and 37 positions they are a good choice for a low cost industry standard connection. These connectors are manufactured with precision stamped contacts offering a choice of contact plating and a wide selection of mating and mounting options.

FEATURES:

- Industry standard compatibility
- Durable metal shell design
- Precision formed contacts
- Variety of Mating and mounting options

MATING CONNECTORS:

Adam Tech D-Subminiatures and all industry standard D-Subminiature connectors.

SPECIFICATIONS:

Material:

Standard insulator: PBT, 30% glass reinforced, rated UL94V-0
 Optional Hi-Temp insulator: Nylon 6T
 Insulator color: Black
 Contacts: Phosphor Bronze
 Shell: Steel, Tin or Zinc plated
 Hardware: Brass, Nickel plated

Contact Plating:

Gold over Nickel underplate on contact area.

Electrical:

Operating voltage: 250V AC / DC max.
 Current rating: 5 Amps max.
 Contact resistance: 20 mΩ max. initial
 Insulation resistance: 5000 MΩ min.
 Dielectric withstanding voltage: 1000V AC for 1 minute

Mechanical:

Insertion force: 0.75 lbs max
 Extraction force: 0.44 lbs min
 Temperature Rating:
 Operating temperature: -55°C to +105°C
 Soldering process temperature:
 Standard insulator: 235°C
 Hi-Temp insulator: 260°C

Packaging:

Anti-ESD plastic trays

Approvals and Certifications:

UL Recognized & CSA Certified, File no. E224053

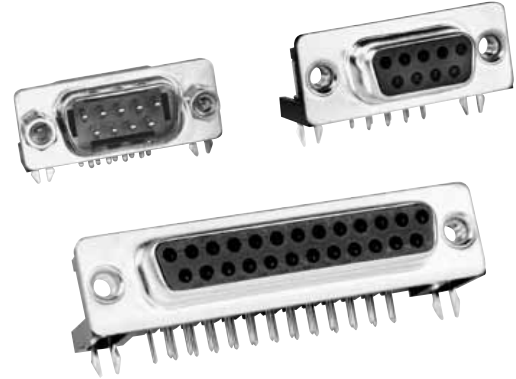

ORDERING INFORMATION



SHELL SIZE/ POSITIONS

DE09 = 9 Position
 DA15 = 15 Position
 DB25 = 25 Position
 DC37 = 37 Position

CONTACT TYPE

PL = Plug, .318" Footprint
 SL = Socket, .318" Footprint

MATING FACE MOUNTING OPTIONS

3 = #4-40 fixed jackscrews
 4 = #4-40 flush threaded inserts
 5 = #4-40 flush threaded inserts with removable jackscrews installed
 6 = .120" non-threaded mounting holes

* See Mounting Option diagrams pg. 77

PCB MOUNTING OPTIONS

1 = Wrap around ground straps with thru holes
 2 = Forked board locks
 3 = Top side only ground straps with thru holes
 4 = Top side only ground straps with #4-40 threaded screw holes

* See Mounting Option diagrams pg. 77

OPTIONS:

Add designator(s) to end of part number

15 = 15 μin gold plating in contact area

30 = 30 μin gold plating in contact area

EMI = Ferrite filtered version for EMI/RFI suppression

LPJ = Loose packed jackscrews

F = Superior retention 4 prong boardlocks

HT = Hi-Temp insulator for Hi-Temp soldering processes up to 260°C

R = Round jackscrews

PF = Press fit pins



PLUG

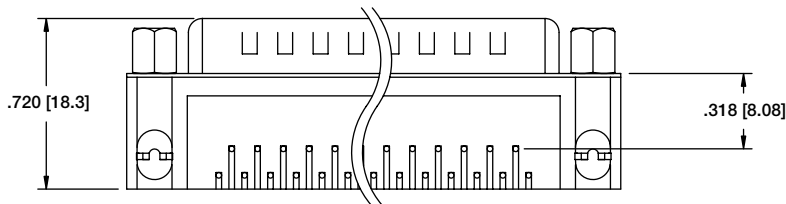
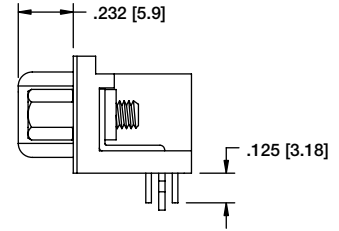
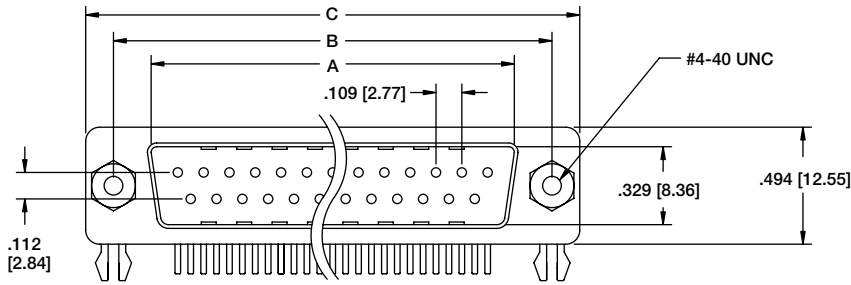

DB25-PL-25

SOCKET

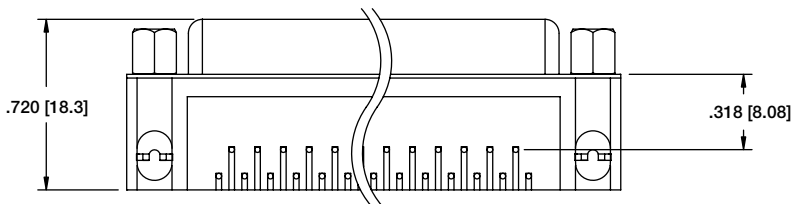
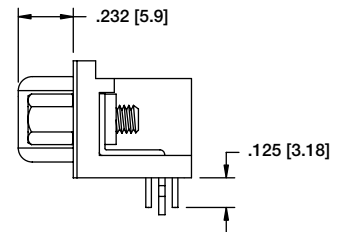
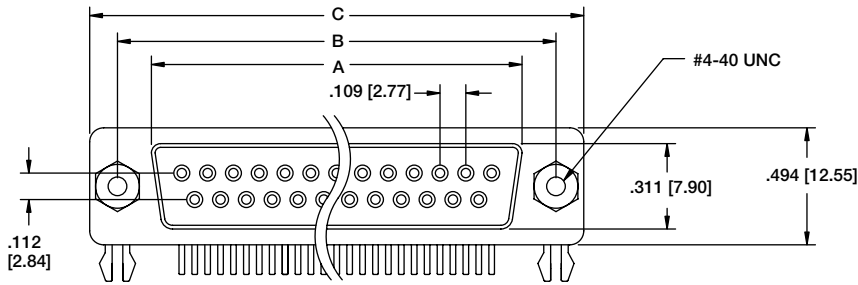

DB25-SL-24

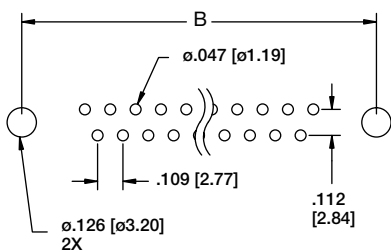

Recommended PCB Layout

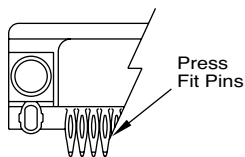

Press Fit Option

Unit: Inch [mm]

Pos.	PLUG	SOCKET	DIMENSIONS	
	A	A	B	C
9	.666 [16.92]	.643 [16.33]	.984 [24.99]	1.213 [30.81]
15	.994 [25.25]	.971 [24.66]	1.312 [33.32]	1.541 [39.14]
25	1.534 [38.96]	1.511 [38.38]	1.852 [47.04]	2.088 [53.04]
37	2.182 [55.43]	2.159 [54.84]	2.500 [63.50]	2.729 [69.32]

MATING FACE & PCB MOUNTING OPTIONS

OPTION 23

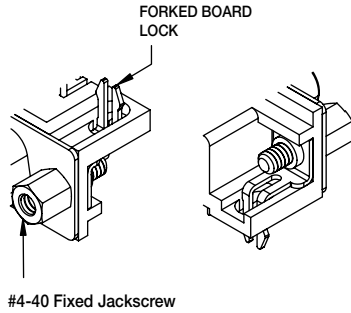

* Standard Stocked Item

OPTION 24

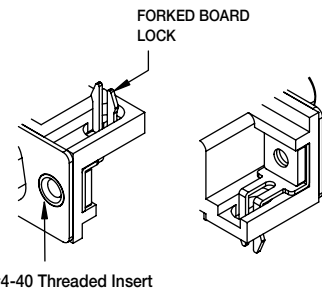

* Standard Stocked Item

OPTION 25

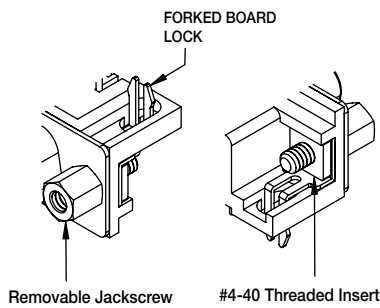

* Standard Stocked Item

OPTION 23-R

#4-40 Rivited Round Jackscrew (Shown)

OPTION 27

#4-40 Rivited Hex Jackscrew (Not Shown)

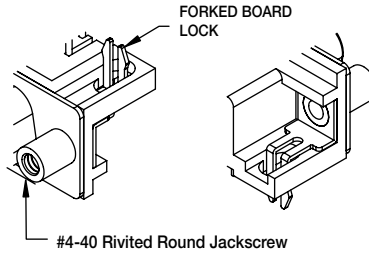

OPTION 26

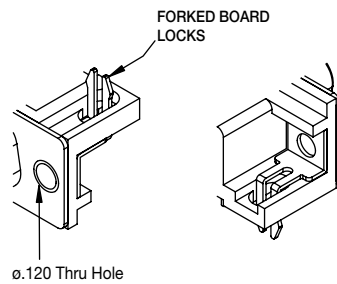

OPTION 34

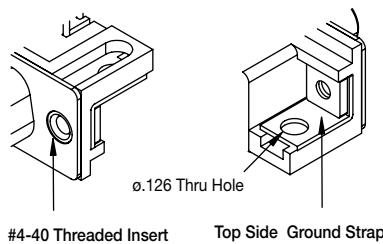

OPTION 36

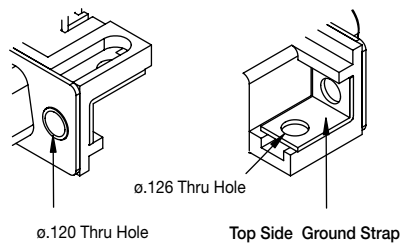

OPTION 24-F

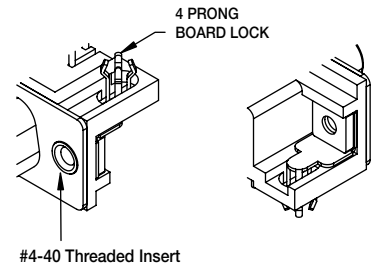

OPTION 33

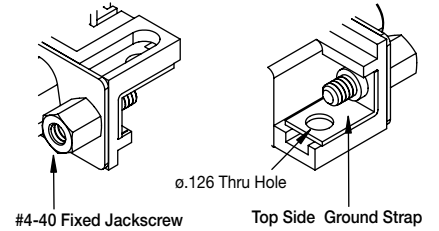

OPTION 35

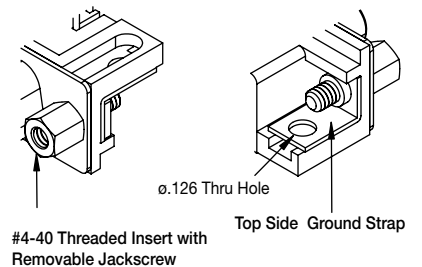

OPTION 43

