

MMBT3904T TRANSISTOR(NPN)

FEATURES

- Complementary to MMBT3906T
- Small Package

MAXIMUM RATINGS (T_A=25°C unless otherwise noted)

Symbol	Parameter	Value	Unit
V _{CBO}	Collector-Base Voltage	60	V
V _{CEO}	Collector-Emitter Voltage	40	V
V _{EBO}	Emitter-Base Voltage	6	V
I _C	Collector Current	200	mA
P _C	Collector Power Dissipation	150	mW
R _{θJA}	Thermal Resistance From Junction To Ambient	833	°C/W
T _j	Junction Temperature	150	°C
T _{stg}	Storage Temperature	-55~+150	°C

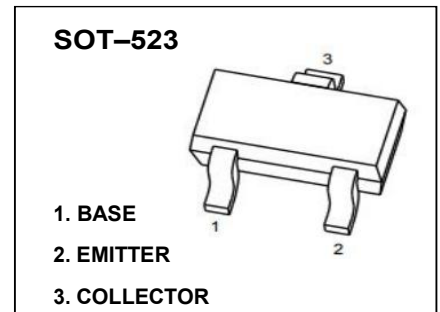

ELECTRICAL CHARACTERISTICS (T_a=25°C unless otherwise specified)

Parameter	Symbol	Test conditions	Min	Typ	Max	Unit
Collector-base breakdown voltage	V _{(BR)CBO}	I _C =10μA, I _E =0	60			V
Collector-emitter breakdown voltage	V _{(BR)CEO}	I _C =1mA, I _B =0	40			V
Emitter-base breakdown voltage	V _{(BR)EBO}	I _E =10μA, I _C =0	6			V
Collector cut-off current	I _{CEX}	V _{CE} =30V, V _{EB(off)} =3V			50	nA
Emitter cut-off current	I _{EBO}	V _{EB} =5V, I _C =0			100	nA
DC current gain	h _{FE(1)}	V _{CE} =1V, I _C =0.1mA	40			
	h _{FE(2)}	V _{CE} =1V, I _C =1mA	70			
	h _{FE(3)}	V _{CE} =1V, I _C =10mA	100		300	
	h _{FE(4)}	V _{CE} =1V, I _C =50mA	60			
Collector-emitter saturation voltage	V _{CE(sat)}	I _C =10mA, I _B =1mA			0.2	V
		I _C =50mA, I _B =5mA			0.3	V
Collector-emitter saturation voltage	V _{BE(sat)}	I _C =10mA, I _B =1mA	0.65		0.85	V
		I _C =50mA, I _B =5mA			0.95	V
Transition frequency	f _T	V _{CE} =20V, I _C =10mA, f=100MHz	300			MHz
Collector output capacitance	C _{ob}	V _{CB} =5V, I _E =0, f=1MHz			4	pF
Base input capacitance	C _{ib}	V _{EB} =0.5V, I _C =0, f=1MHz			8	pF
Delay time	t _d	V _{CC} =3V, V _{BE(off)} =-0.5V, I _C =10mA, I _{B1} =1mA			35	ns
Rise time	t _r	V _{CC} =3V, V _{BE(off)} =-0.5V, I _C =10mA, I _{B1} =1mA			35	ns
Storage time	t _s	V _{CC} =3V, I _C =10mA, I _{B1} =I _{B2} =1mA			200	ns
Fall time	t _f	V _{CC} =3V, I _C =10mA, I _{B1} =I _{B2} =1mA			50	ns

Typical Characteristics

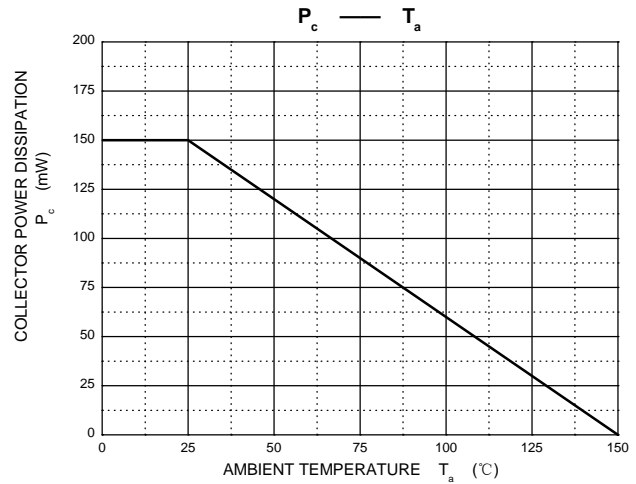
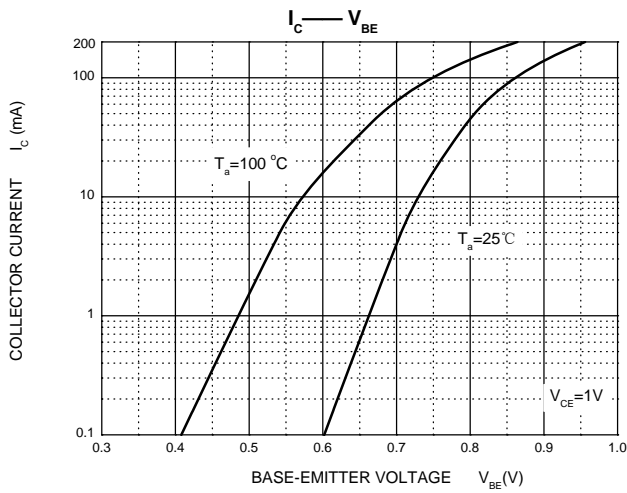
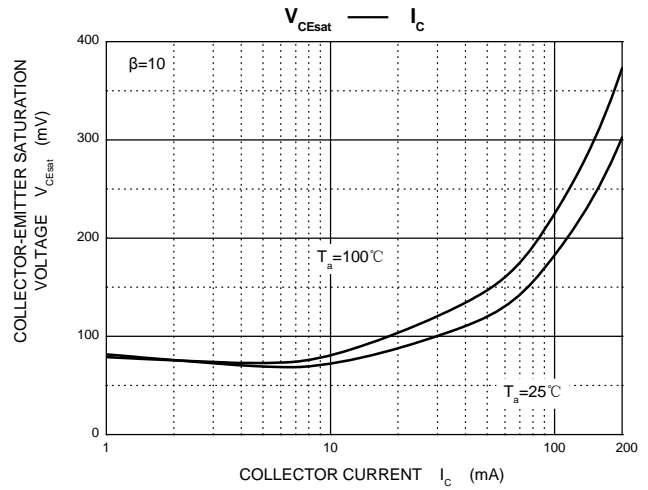
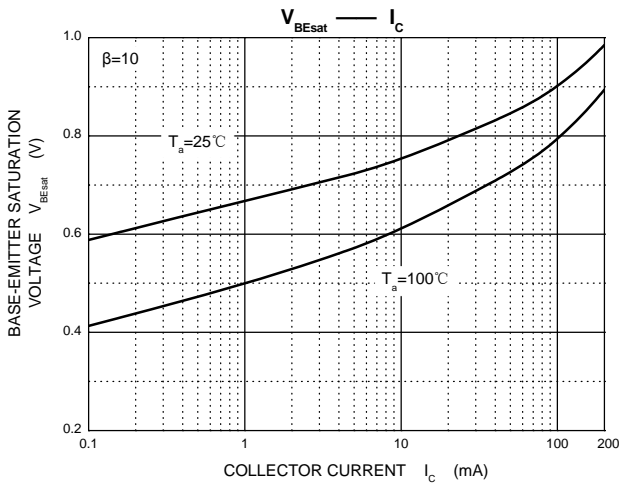
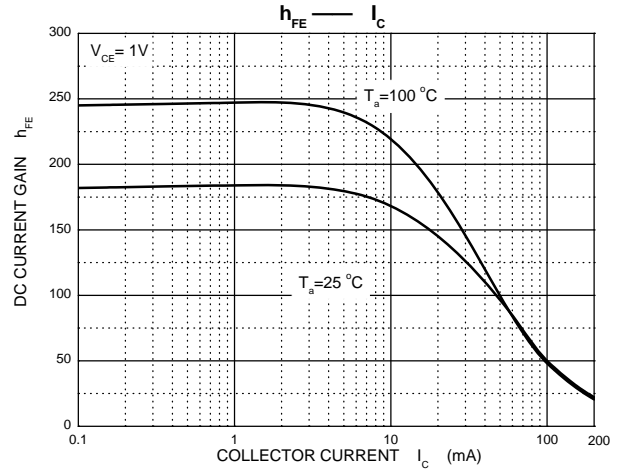
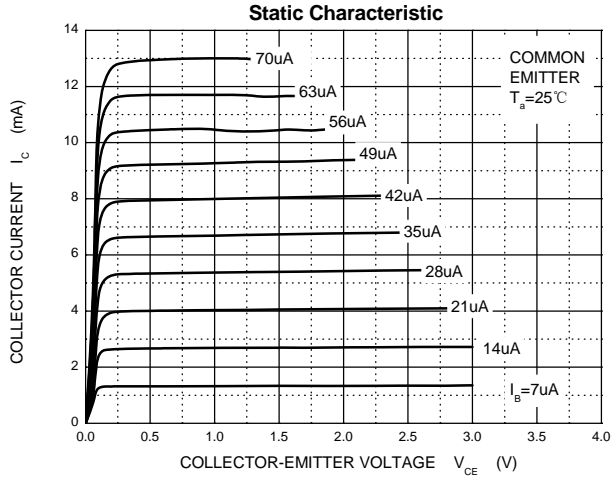

PACKAGE OUTLINE

Plastic surface mounted package; 3 leads

SOT-523

