

THIS DRAWING IS UNPUBLISHED. RELEASED FOR PUBLICATION 20
 © COPYRIGHT 20 BY - ALL RIGHTS RESERVED.

REVISIONS					
P	LTR	DESCRIPTION	DATE	DWN	APVD
	C3	REVISED PER ECR-16-011494	20JUN2017	NK	CX

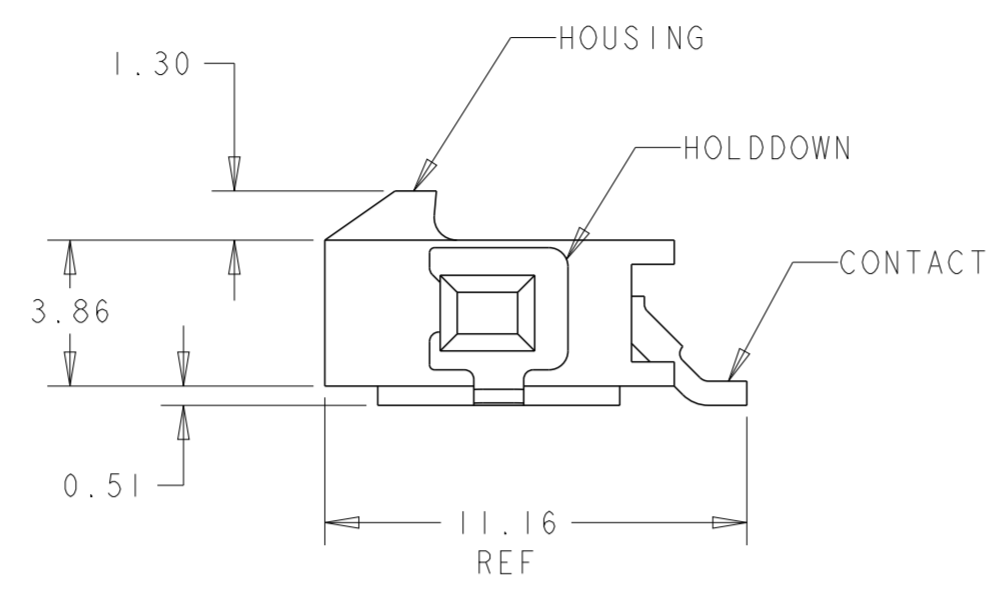

- 1 MATERIAL: CONTACTS - BRASS
HOUSING - UL 94V-0 RATED HIGH TEMP NYLON, COLOR BLACK.
HOLDDOWNS: - PHOSPHOR BRONZE.
- 2 PLATING: CONTACTS- 2.54µm MINIMUM TIN LEAD OVER 1.27µm MINIMUM NICKEL.
HOLDDOWNS- 2.54µm MINIMUM TIN-LEAD OVER 1.27µm MINIMUM NICKEL.
- 4 RECOMMENDED PC BOARD THICKNESS OF 1.57.
- 5 PLATING: CONTACTS-2.54µm MINIMUM TIN OVER 1.27µm MINIMUM NICKEL.
HOLDDOWNS- 2.54µm MINIMUM TIN OVER 1.27µm MINIMUM NICKEL.

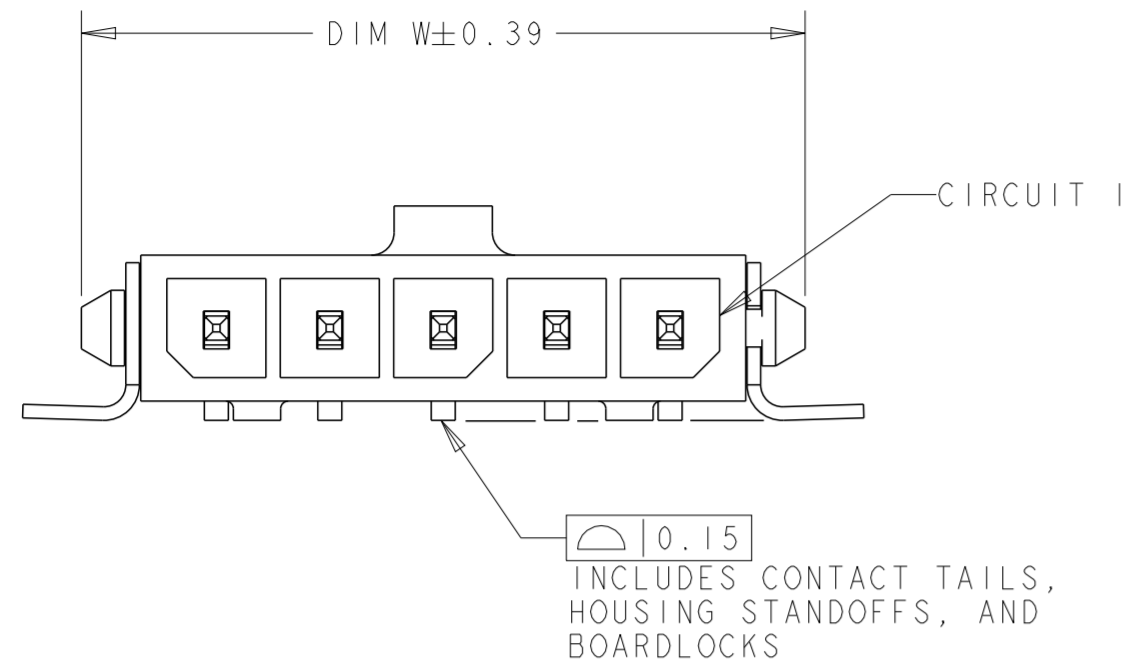
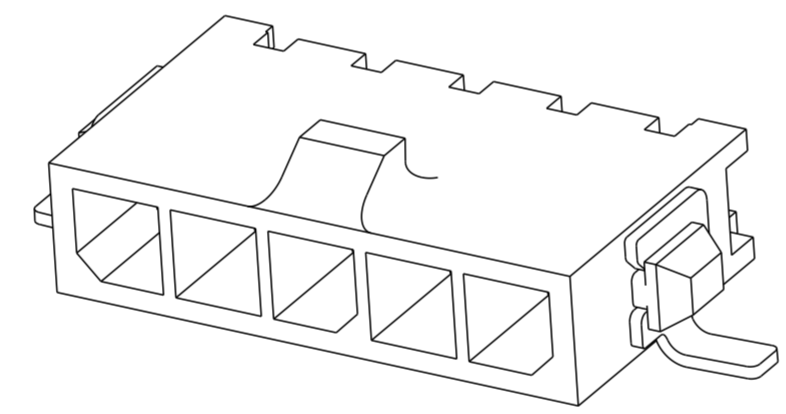
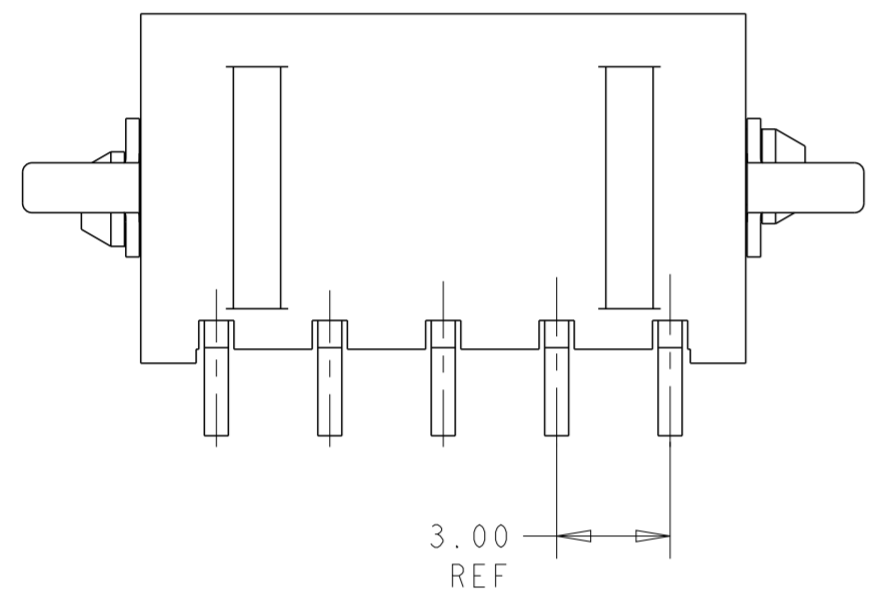

5	33.00	40.27	40.00	12	3-1445057-2
5	30.00	37.27	37.00	11	3-1445057-1
5	27.00	34.27	34.00	10	3-1445057-0
5	24.00	31.27	31.00	9	2-1445057-9
5	21.00	28.27	28.00	8	2-1445057-8
5	18.00	25.27	25.00	7	2-1445057-7
5	15.00	22.27	22.00	6	2-1445057-6
5	12.00	19.27	19.00	5	2-1445057-5
5	9.00	16.27	16.00	4	2-1445057-4
5	6.00	13.27	13.00	3	2-1445057-3
5	3.00	10.27	10.00	2	2-1445057-2

SUPERSEDED BY 3-1445057-2	5	33.00	40.27	40.00	12	3-1445057-2
SUPERSEDED BY 3-1445057-1	5	30.00	37.27	37.00	11	3-1445057-1
SUPERSEDED BY 3-1445057-0	5	27.00	34.27	34.00	10	3-1445057-0
SUPERSEDED BY 2-1445057-9	5	24.00	31.27	31.00	9	2-1445057-9
SUPERSEDED BY 2-1445057-8	5	21.00	28.27	28.00	8	2-1445057-8
SUPERSEDED BY 2-1445057-7	5	18.00	25.27	25.00	7	2-1445057-7
SUPERSEDED BY 2-1445057-6	5	15.00	22.27	22.00	6	2-1445057-6
SUPERSEDED BY 2-1445057-5	5	12.00	19.27	19.00	5	2-1445057-5
SUPERSEDED BY 2-1445057-4	5	9.00	16.27	16.00	4	2-1445057-4
SUPERSEDED BY 2-1445057-3	5	6.00	13.27	13.00	3	2-1445057-3
SUPERSEDED BY 2-1445057-2	5	3.00	10.27	10.00	2	2-1445057-2

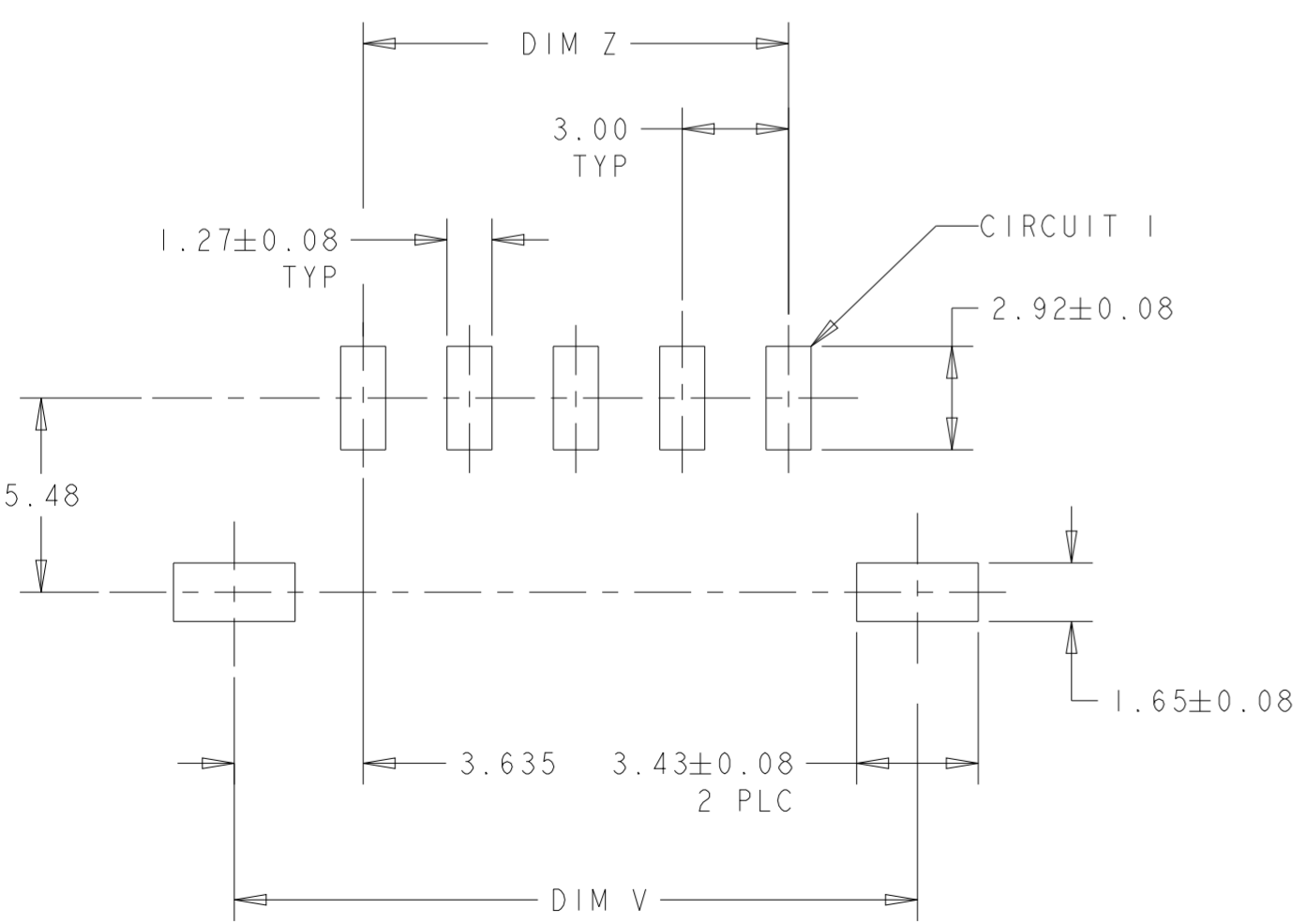

PCB LAYOUT COMPONENT SIDE 4

THIS DRAWING IS A CONTROLLED DOCUMENT.		DWN J. ROOT 03-OCT-2000	TE Connectivity	
DIMENSIONS: mm		CHK K. WHITAKER 13-MAR-2001		
TOLERANCES UNLESS OTHERWISE SPECIFIED:		APVD K. WHITAKER 13-MAR-2001	NAME RT ANGLE SURFACE MOUNT HEADER ASSY, TIN CONTACTS W/SURF MOUNT HOLDDOWNS, SINGLE ROW, MICRO MATE-N-LOK™	
0 PLC ±		PRODUCT SPEC 108-1836	SIZE A2	
1 PLC ±		APPLICATION SPEC 114-13000	CAGE CODE 00779	
2 PLC ±0.13		WEIGHT -	DRAWING NO C-1445057	
3 PLC ±		CUSTOMER DRAWING	RESTRICTED TO -	
4 PLC ±		SCALE 5:1	SHEET 1 OF 1	
ANGLES ±		REV C3		
FINISH SEE TABLE				

Mouser Electronics

Authorized Distributor

Click to View Pricing, Inventory, Delivery & Lifecycle Information:

[TE Connectivity:](#)

[2-1445057-2](#)