

# ON Semiconductor

## Is Now

# onsemi™

To learn more about onsemi™, please visit our website at  
[www.onsemi.com](http://www.onsemi.com)

---

**onsemi** and **onsemi** and other names, marks, and brands are registered and/or common law trademarks of Semiconductor Components Industries, LLC dba "**onsemi**" or its affiliates and/or subsidiaries in the United States and/or other countries. **onsemi** owns the rights to a number of patents, trademarks, copyrights, trade secrets, and other intellectual property. A listing of **onsemi** product/patent coverage may be accessed at [www.onsemi.com/site/pdf/Patent-Marking.pdf](http://www.onsemi.com/site/pdf/Patent-Marking.pdf). **onsemi** reserves the right to make changes at any time to any products or information herein, without notice. The information herein is provided "as-is" and **onsemi** makes no warranty, representation or guarantee regarding the accuracy of the information, product features, availability, functionality, or suitability of its products for any particular purpose, nor does **onsemi** assume any liability arising out of the application or use of any product or circuit, and specifically disclaims any and all liability, including without limitation special, consequential or incidental damages. Buyer is responsible for its products and applications using **onsemi** products, including compliance with all laws, regulations and safety requirements or standards, regardless of any support or applications information provided by **onsemi**. "Typical" parameters which may be provided in **onsemi** data sheets and/or specifications can and do vary in different applications and actual performance may vary over time. All operating parameters, including "Typicals" must be validated for each customer application by customer's technical experts. **onsemi** does not convey any license under any of its intellectual property rights nor the rights of others. **onsemi** products are not designed, intended, or authorized for use as a critical component in life support systems or any FDA Class 3 medical devices or medical devices with a same or similar classification in a foreign jurisdiction or any devices intended for implantation in the human body. Should Buyer purchase or use **onsemi** products for any such unintended or unauthorized application, Buyer shall indemnify and hold **onsemi** and its officers, employees, subsidiaries, affiliates, and distributors harmless against all claims, costs, damages, and expenses, and reasonable attorney fees arising out of, directly or indirectly, any claim of personal injury or death associated with such unintended or unauthorized use, even if such claim alleges that **onsemi** was negligent regarding the design or manufacture of the part. **onsemi** is an Equal Opportunity/Affirmative Action Employer. This literature is subject to all applicable copyright laws and is not for resale in any manner. Other names and brands may be claimed as the property of others.



ON Semiconductor®

# FAN53601 / FAN53611

## 6 MHz, 600 mA / 1 A Synchronous Buck Regulator

### Features

- 600 mA or 1 A Output Current Capability
- 24  $\mu$ A Typical Quiescent Current
- 6 MHz Fixed-Frequency Operation
- Best-in-Class Load Transient Response
- Best-in-Class Efficiency
- 2.3 V to 5.5 V Input Voltage Range
- Low Ripple Light-Load PFM Mode
- Forced PWM and External Clock Synchronization
- Internal Soft-Start
- Input Under-Voltage Lockout (UVLO)
- Thermal Shutdown and Overload Protection
- Optional Output Discharge
- 6-Bump WLCSP, 0.4 mm Pitch

### Applications

- 3G, 4G, WiFi®, WiMAX™, and WiBro® Data Cards
- Tablets
- DSC, DVC
- Netbooks®, Ultra-Mobile PCs

All trademarks are the property of their respective owners.

### Description

The FAN53601/11 is a 6 MHz, step-down switching voltage regulator, available in 600 mA or 1 A options, that delivers a fixed output from an input voltage supply of 2.3 V to 5.5 V. Using a proprietary architecture with synchronous rectification, the FAN53601/11 is capable of delivering a peak efficiency of 92%, while maintaining efficiency over 80% at load currents as low as 1 mA.

The regulator operates at a nominal fixed frequency of 6 MHz, which reduces the value of the external components to as low as 470 nH for the output inductor and 4.7  $\mu$ F for the output capacitor. In addition, the Pulse Width Modulation (PWM) modulator can be synchronized to an external frequency source.

At moderate and light loads, Pulse Frequency Modulation (PFM) is used to operate the device in Power-Save Mode with a typical quiescent current of 24  $\mu$ A. Even with such a low quiescent current, the part exhibits excellent transient response during large load swings. At higher loads, the system automatically switches to fixed-frequency control, operating at 6 MHz. In Shutdown Mode, the supply current drops below 1  $\mu$ A, reducing power consumption. For applications that require minimum ripple or fixed frequency, PFM Mode can be disabled using the MODE pin.

The FAN53601/11 is available in 6-bump, 0.4 mm pitch, Wafer-Level Chip-Scale Package (WLCSP).

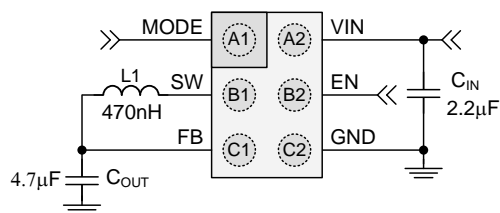

Figure 1. Typical Application

## Ordering Information

Part Number	Output Voltage <sup>(1)</sup>	Max. Output Current	Active Discharge <sup>(2)</sup>	Max. V <sub>IN</sub>	Package	Temperature Range	Packing
FAN53601AUC10X	1.000 V	600 mA	Yes	5.5 V	WLCSP-6, 0.4 mm Pitch	-40 to +85°C	Tape and Reel
FAN53601AUC105X	1.050 V	600 mA	Yes				
FAN53611AUC11X	1.100 V	1 A	Yes				
FAN53611AUC115X	1.150 V	1 A	Yes				
FAN53611AUC13X	1.300 V	1 A	Yes				
FAN53611AUC135X	1.350 V	1 A	Yes				
FAN53611UC123X	1.233 V	1 A	No				
FAN53601UC182X	1.820 V	600 mA	No				
FAN53611AUC205X	2.050 V	1 A	Yes				
FAN53611AUC123X	1.233 V	1 A	Yes				
FAN53611AUC12X	1.200 V	1 A	Yes				
FAN53611AUC18X	1.800 V	1 A	Yes				

### Notes:

- Other voltage options available on request. Contact a ON Semiconductor representative.
- All voltage and output current options are available with or without active discharge. Contact a ON Semiconductor representative.

## Pin Configurations

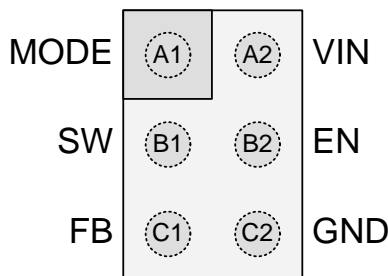

Figure 2. Bumps Facing Down

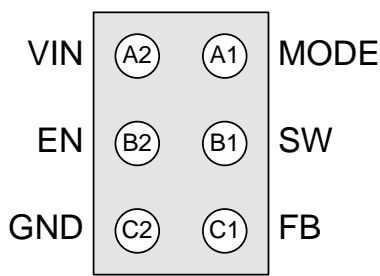

Figure 3. Bumps Facing Up

## Pin Definitions

Pin #	Name	Description
A1	MODE	<b>MODE</b> Logic 1 on this pin forces the IC to stay in PWM Mode. A logic 0 allows the IC to automatically switch to PFM during light loads. The regulator also synchronizes its switching frequency to four times the frequency provided on this pin. Do not leave this pin floating.
B1	SW	<b>Switching Node</b> . Connect to output inductor.
C1	FB	<b>Feedback / V<sub>OUT</sub></b> . Connect to output voltage.
C2	GND	<b>Ground</b> . Power and IC ground. All signals are referenced to this pin.
B2	EN	<b>Enable</b> . The device is in Shutdown Mode when voltage to this pin is < 0.4 V and enabled when > 1.2 V. Do not leave this pin floating.
A2	VIN	<b>Input Voltage</b> . Connect to input power source.

## Absolute Maximum Ratings

Stresses exceeding the absolute maximum ratings may damage the device. The device may not function or be operable above the recommended operating conditions and stressing the parts to these levels is not recommended. In addition, extended exposure to stresses above the recommended operating conditions may affect device reliability. The absolute maximum ratings are stress ratings only.

Symbol	Parameter	Min.	Max.	Units
$V_{IN}$	Input Voltage	-0.3	7.0	V
$V_{SW}$	Voltage on SW Pin	-0.3	$V_{IN} + 0.3^{(3)}$	V
$V_{CTRL}$	EN and MODE Pin Voltage	-0.3	$V_{IN} + 0.3^{(3)}$	V
	Other Pins	-0.3	$V_{IN} + 0.3^{(3)}$	V
ESD	Electrostatic Discharge Protection Level	Human Body Model per JESD22-A114		kV
		Charged Device Model per JESD22-C101		
$T_J$	Junction Temperature	-40	+150	°C
$T_{STG}$	Storage Temperature	-65	+150	°C
$T_L$	Lead Soldering Temperature, 10 Seconds		+260	°C

### Note:

3. Lesser of 7 V or  $V_{IN} + 0.3$  V.

## Recommended Operating Conditions

The Recommended Operating Conditions table defines the conditions for actual device operation. Recommended operating conditions are specified to ensure optimal performance to the datasheet specifications. ON Semiconductor does not recommend exceeding them or designing to Absolute Maximum Ratings.

Symbol	Parameter	Min.	Typ.	Max.	Units
$V_{CC}$	Supply Voltage Range	2.3		5.5	V
$I_{OUT}$	Output Current for FAN53601	0		600	mA
	Output Current for FAN53611	0		1	A
L	Inductor		470		nH
$C_{IN}$	Input Capacitor		2.2		μF
$C_{OUT}$	Output Capacitor	1.6	4.7	12.0	μF
$T_A$	Operating Ambient Temperature	-40		+85	°C
$T_J$	Operating Junction Temperature	-40		+125	°C

## Thermal Properties

Junction-to-ambient thermal resistance is a function of application and board layout. This data is measured with four-layer 2s2p boards in accordance to JEDEC standard JESD51. Special attention must be paid to not exceed junction temperature  $T_{J(max)}$  at a given ambient temperature  $T_A$ .

Symbol	Parameter	Typical	Unit
$\theta_{JA}$	Junction-to-Ambient Thermal Resistance	125	°C/W

### Electrical Characteristics

Minimum and maximum values are at  $V_{IN} = V_{EN} = 2.3\text{ V to }5.5\text{ V}$ ,  $V_{MODE} = 0\text{ V}$  (AUTO Mode),  $T_A = -40^\circ\text{C to }+85^\circ\text{C}$ ; circuit of Figure 1, unless otherwise noted. Typical values are at  $T_A = 25^\circ\text{C}$ ,  $V_{IN} = V_{EN} = 3.6\text{ V}$ .

Symbol	Parameter	Conditions	Min.	Typ.	Max.	Units	
<b>Power Supplies</b>							
$I_Q$	Quiescent Current	No Load, Not Switching		24	50	$\mu\text{A}$	
		PWM Mode		8		$\text{mA}$	
$I_{SD}$	Shutdown Supply Current	$EN = \text{GND}$ , $V_{IN} = 3.6\text{ V}$		0.25	1.00	$\mu\text{A}$	
$V_{UVLO}$	Under-Voltage Lockout Threshold	Rising $V_{IN}$		2.15	2.27	V	
$V_{UVHYS}$	Under-Voltage Lockout Hysteresis			200		$\text{mV}$	
<b>Logic Inputs: EN and MODE Pins</b>							
$V_{IH}$	Enable HIGH-Level Input Voltage		1.2			V	
$V_{IL}$	Enable LOW-Level Input Voltage				0.4	V	
$V_{LHYS}$	Logic Input Hysteresis Voltage			100		$\text{mV}$	
$I_{IN}$	Enable Input Leakage Current	Pin to $V_{IN}$ or GND		0.01	1.00	$\mu\text{A}$	
<b>Switching and Synchronization</b>							
$f_{SW}$	Switching Frequency <sup>(4)</sup>	$V_{IN} = 3.6\text{ V}$ , $T_A = 25^\circ\text{C}$ , PWM Mode, $I_{LOAD} = 10\text{ mA}$	5.4	6.0	6.6	MHz	
$f_{SYNC}$	MODE Synchronization Range <sup>(4)</sup>	Square Wave at MODE Input	1.3	1.5	1.7	MHz	
<b>Regulation</b>							
$V_O$	Output Voltage Accuracy	1.000 V	$I_{LOAD} = 0\text{ to }600\text{ mA}$	0.953	1.000	1.048	V
			PWM Mode	0.967	1.000	1.034	
		1.35 V	$I_{LOAD} = 0\text{ to }1\text{ A}$	1.298	1.350	1.402	
			PWM mode	1.309	1.350	1.391	
		1.233 V	$I_{LOAD} = 0\text{ to }1\text{ A}$	1.185	1.233	1.281	
			PWM Mode	1.192	1.233	1.274	
		1.820 V	$I_{LOAD} = 0\text{ to }600\text{ mA}$	1.755	1.820	1.885	
			PWM Mode	1.781	1.820	1.859	
		1.100 V	$I_{LOAD} = 0\text{ to }1\text{ A}$	1.054	1.100	1.147	
			PWM Mode	1.061	1.100	1.140	
		1.300 V	$I_{LOAD} = 0\text{ to }1\text{ A}$	1.250	1.300	1.350	
			PWM Mode	1.259	1.300	1.341	
		1.150 V	$I_{LOAD} = 0\text{ to }1\text{ A}$	1.104	1.150	1.196	
			PWM Mode	1.110	1.150	1.190	
		1.050 V	$I_{LOAD} = 0\text{ to }600\text{ mA}$	1.003	1.050	1.097	
			PWM Mode	1.016	1.050	1.084	
		2.050 V	$I_{LOAD} = 0\text{ to }1\text{ A}$ , $V_{IN} = 2.7\text{ V to }5.5\text{ V}$	1.973	2.050	2.127	
			PWM Mode, $V_{IN} = 2.7\text{ V to }5.5\text{ V}$	2.004	2.050	2.096	
1.200 V	$I_{LOAD} = 0\text{ to }1\text{ A}$	1.152	1.200	1.248			
	PWM Mode	1.160	1.200	1.240			
1.800 V	$I_{LOAD} = 0\text{ to }1\text{ A}$	1.732	1.800	1.868			
	PWM Mode	1.756	1.800	1.844			
$t_{SS}$	Soft-Start	$V_{IN} = 4.5\text{ V}$ , From EN Rising Edge		180	300	$\mu\text{s}$	

**Electrical Characteristics (Continued)**

Minimum and maximum values are at  $V_{IN} = V_{EN} = 2.3\text{ V}$  to  $5.5\text{ V}$ ,  $V_{MODE} = 0\text{ V}$  (AUTO Mode),  $T_A = -40^\circ\text{C}$  to  $+85^\circ\text{C}$ ; circuit of Figure 1, unless otherwise noted. Typical values are at  $T_A = 25^\circ\text{C}$ ,  $V_{IN} = V_{EN} = 3.6\text{ V}$ .

Symbol	Parameter	Conditions	Min.	Typ.	Max.	Units
<b>Output Driver</b>						
$R_{DS(on)}$	PMOS On Resistance	$V_{IN} = V_{GS} = 3.6\text{ V}$		175		$\text{m}\Omega$
	NMOS On Resistance	$V_{IN} = V_{GS} = 3.6\text{ V}$		165		$\text{m}\Omega$
$I_{LIM(OL)}$	PMOS Peak Current Limit	Open-Loop for FAN53601, $V_{IN} = 3.6\text{ V}$ , $T_A = 25^\circ\text{C}$	900	1100	1250	mA
		Open-Loop for FAN53611, $V_{IN} = 3.6\text{ V}$ , $T_A = 25^\circ\text{C}$	1500	1750	2000	mA
$R_{DIS}$	Output Discharge Resistance	$EN = GND$		230		$\Omega$
$T_{TSD}$	Thermal Shutdown			150		$^\circ\text{C}$
$T_{HYS}$	Thermal Shutdown Hysteresis			15		$^\circ\text{C}$

**Notes:**

- Limited by the effect of  $t_{OFF}$  minimum (see Operation Description section).
- The Electrical Characteristics table reflects open-loop data. Refer to the Operation Description and Typical Characteristics Sections for closed-loop data.

## Typical Performance Characteristics

Unless otherwise noted,  $V_{IN} = V_{EN} = 3.6\text{ V}$ ,  $V_{MODE} = 0\text{ V}$  (AUTO Mode),  $V_{OUT} = 1.82\text{ V}$ , and  $T_A = 25^\circ\text{C}$ .

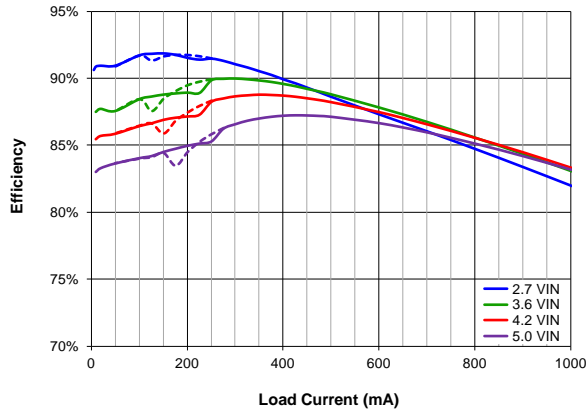

**Figure 4. Efficiency vs. Load Current and Input Voltage, Auto Mode, Dotted for Decreasing Load**

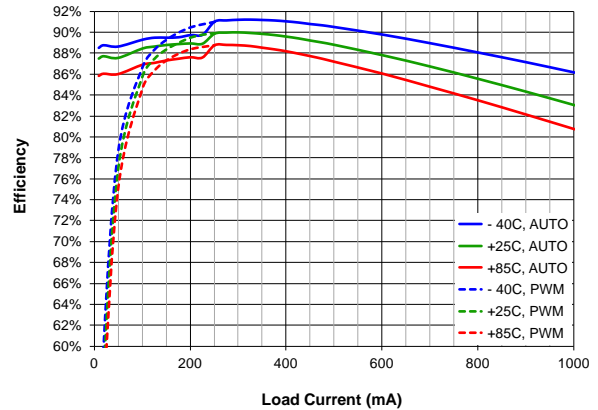

**Figure 5. Efficiency vs. Load Current and Temperature, Auto Mode, Dotted for FPWM**

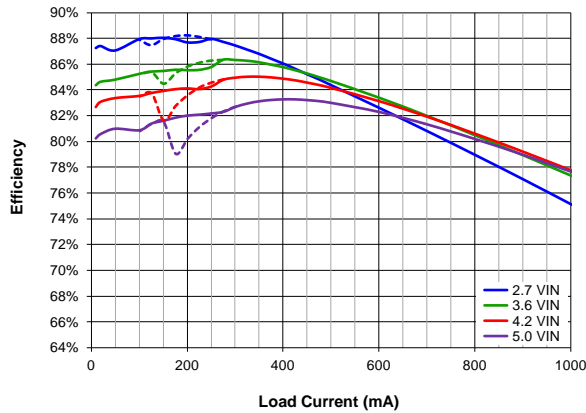

**Figure 6. Efficiency vs. Load Current and Input Voltage,  $V_{OUT} = 1.23\text{ V}$ , Auto Mode, Dotted for Decreasing Load**

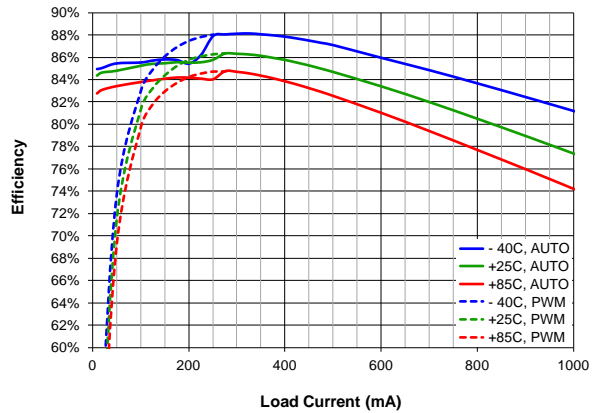

**Figure 7. Efficiency vs. Load Current and Temperature,  $V_{OUT} = 1.23\text{ V}$ , Auto Mode, Dotted for FPWM**

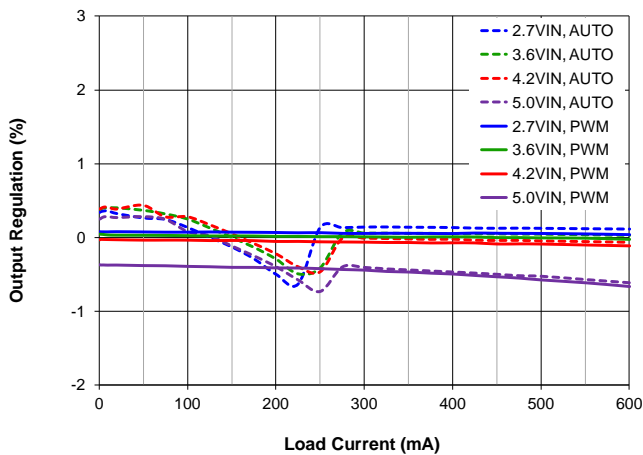

**Figure 8. Output Regulation vs. Load Current,  $V_{OUT} = 1.00\text{ V}$ , Dotted for Auto Mode**

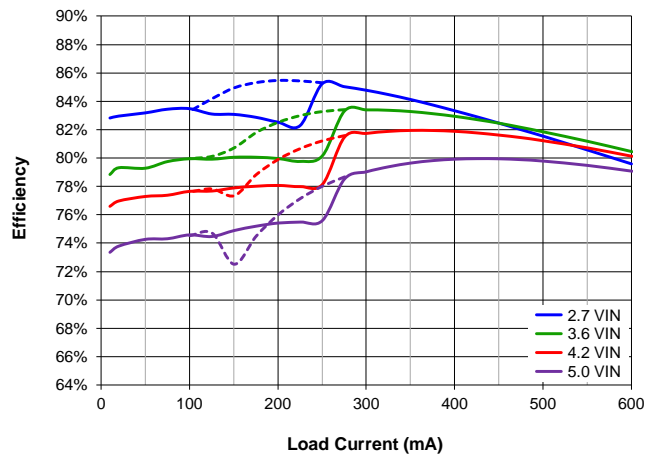

**Figure 9. Efficiency vs. Load Current,  $V_{OUT} = 1.00\text{ V}$ , Dotted for Decreasing Load**

### Typical Performance Characteristics (Continued)

Unless otherwise noted,  $V_{IN} = V_{EN} = 3.6\text{ V}$ ,  $V_{MODE} = 0\text{ V}$  (AUTO Mode),  $V_{OUT} = 1.82\text{ V}$ , and  $T_A = 25^\circ\text{C}$ .

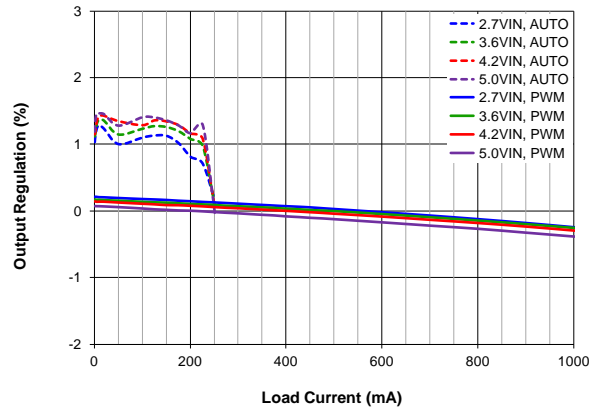

**Figure 10.  $\Delta V_{OUT}$  (%) vs. Load Current and Input Voltage, Normalized to  $3.6 V_{IN}$ , 500 mA Load, FPWM, Dotted for Auto Mode**

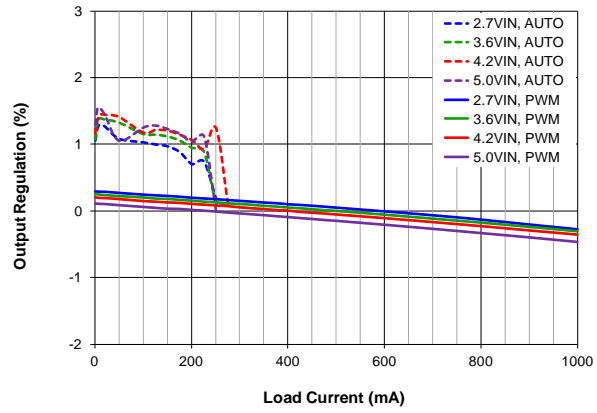

**Figure 11.  $\Delta V_{OUT}$  (%) vs. Load Current and Input Voltage,  $V_{OUT} = 1.23\text{ V}$ , Normalized to  $3.6 V_{IN}$ , 500 mA Load, FPWM, Dotted for Auto Mode**

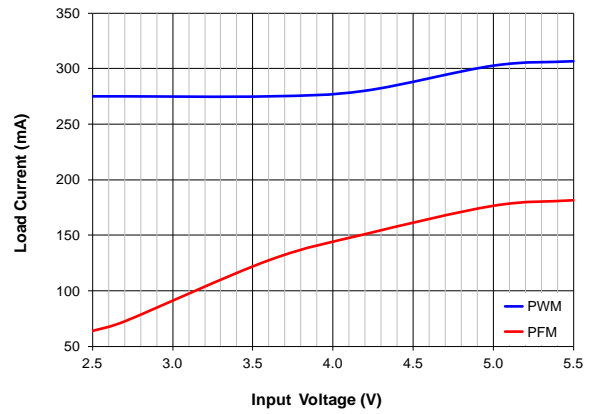

**Figure 12. PFM / PWM Boundary vs. Input Voltage**

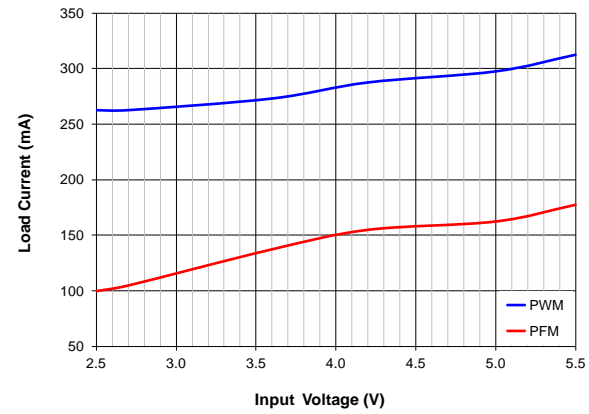

**Figure 13. PFM / PWM Boundary vs. Input Voltage,  $V_{OUT} = 1.23\text{ V}$**

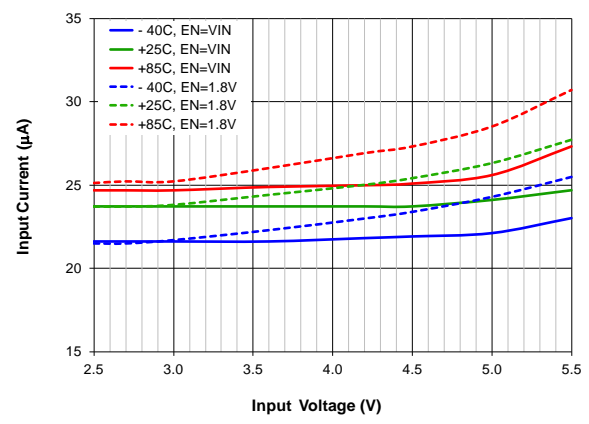

**Figure 14. Quiescent Current vs. Input Voltage and Temperature, Auto Mode;  $EN = V_{IN}$  Solid, Dotted for  $EN = 1.8\text{ V}$  ( $-40^\circ\text{C}$ ,  $+25^\circ\text{C}$ ,  $+85^\circ\text{C}$ )**

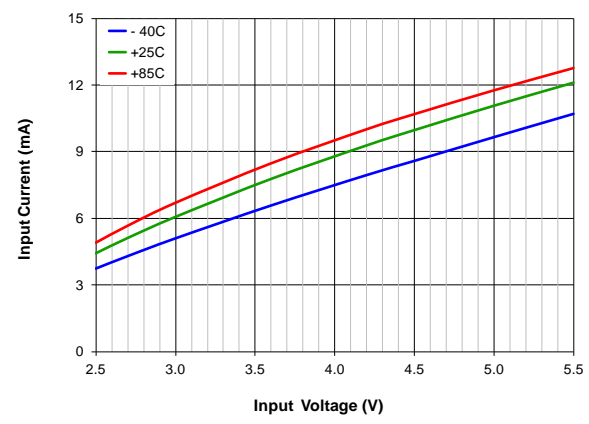
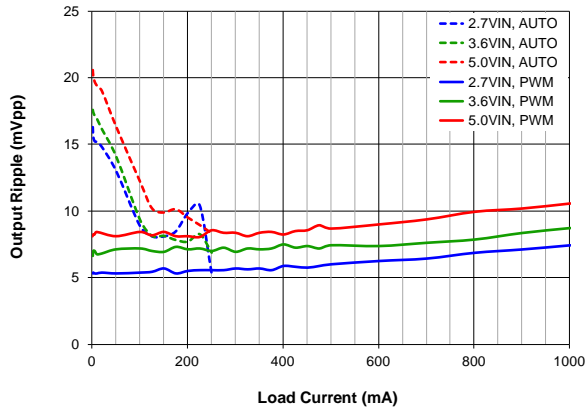

**Figure 15. Quiescent Current vs. Input Voltage and Temperature, Mode =  $EN = V_{IN}$  (FPWM)**



## Typical Performance Characteristics (Continued)

Unless otherwise noted,  $V_{IN} = V_{EN} = 3.6\text{ V}$ ,  $V_{MODE} = 0\text{ V}$  (AUTO Mode),  $V_{OUT} = 1.82\text{ V}$ , and  $T_A = 25^\circ\text{C}$ .



**Figure 16. Output Ripple vs. Load Current and Input Voltage, FPWM, Dotted for Auto Mode**

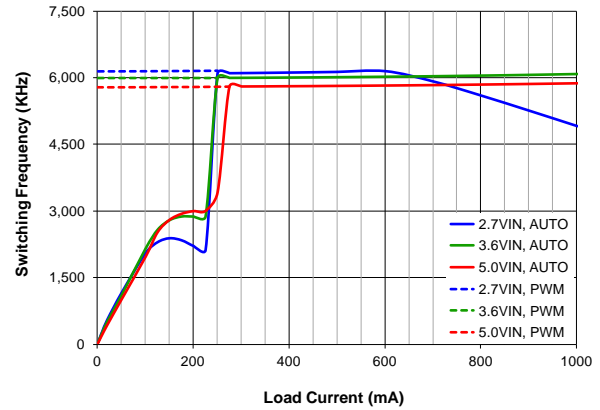

**Figure 17. Frequency vs. Load Current and Input Voltage, Auto Mode, Dotted for FPWM**

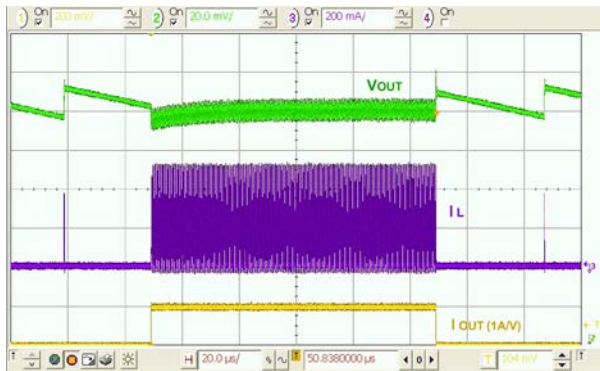

**Figure 18. Load Transient, 10-200-10 mA, 100 ns Edge**

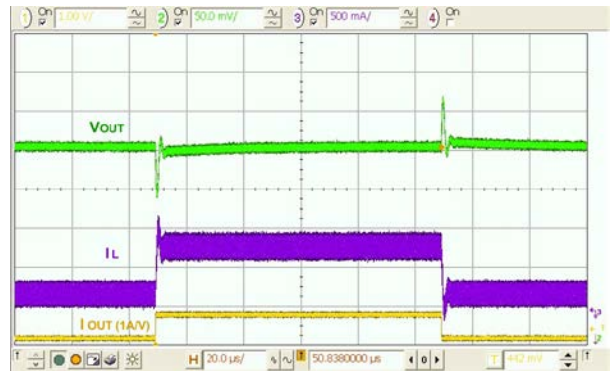

**Figure 19. Load Transient, 200-800-200 mA, 100 ns Edge**

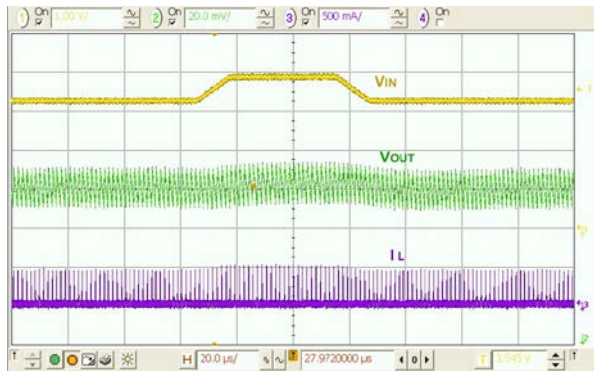

**Figure 20. Line Transient, 3.3-3.9-3.3  $V_{IN}$ , 10  $\mu\text{s}$  Edge, 36 mA Load**



**Figure 21. Line Transient, 3.3-3.9-3.3  $V_{IN}$ , 10  $\mu\text{s}$  Edge, 600 mA Load**

**Typical Performance Characteristics** (Continued)

Unless otherwise noted,  $V_{IN} = V_{EN} = 3.6\text{ V}$ ,  $V_{MODE} = 0\text{ V}$  (AUTO Mode),  $V_{OUT} = 1.82\text{ V}$ , and  $T_A = 25^\circ\text{C}$ .

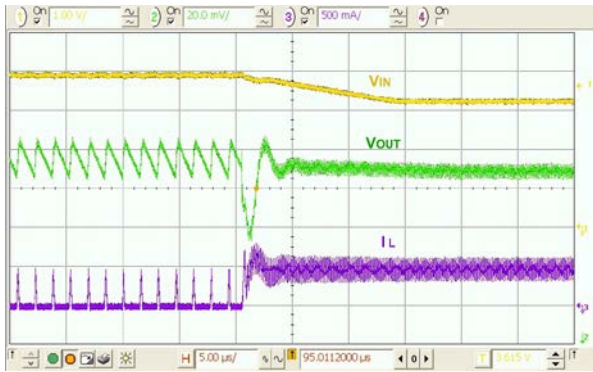

**Figure 22. Combined Line / Load Transient, 3.9-3.3  $V_{IN}$ , 10  $\mu\text{s}$  Edge, 36-400 mA Load, 100 ns Edge**

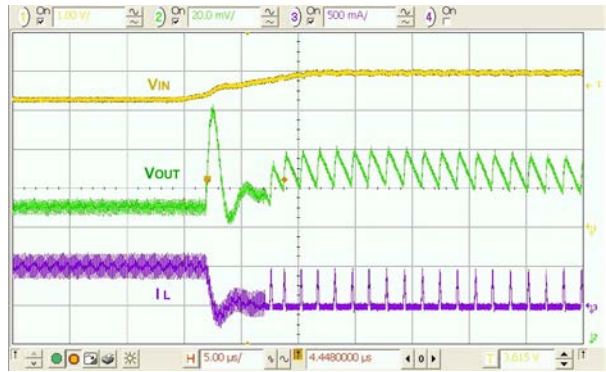

**Figure 23. Combined Line / Load Transient, 3.3-3.9  $V_{IN}$ , 10  $\mu\text{s}$  Edge, 400-36 mA Load, 100 ns Edge**

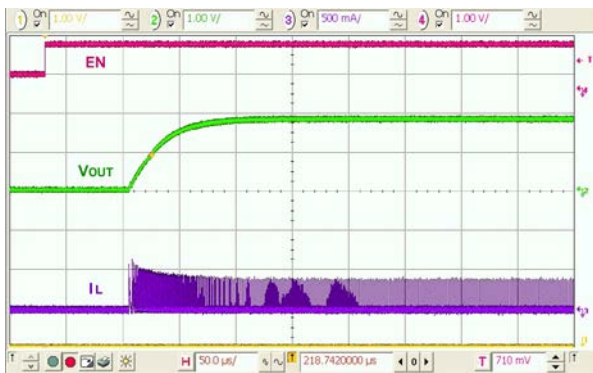

**Figure 24. Startup, 50  $\Omega$  Load**

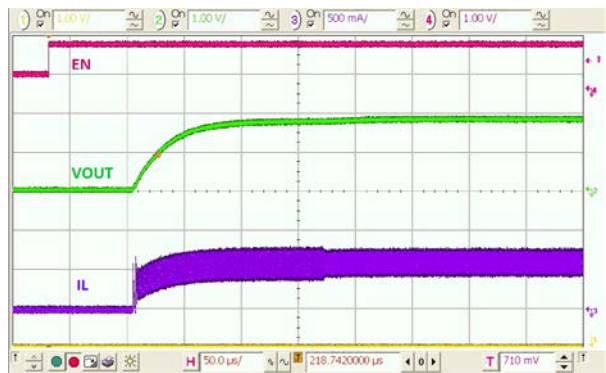

**Figure 25. Startup, 3  $\Omega$  Load**

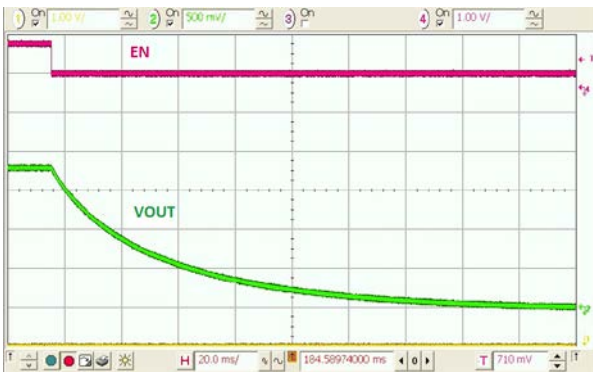

**Figure 26. Shutdown, 10k  $\Omega$  Load, No Output Discharge**



**Figure 27. Shutdown, No Load, Output Discharge Enabled**

### Typical Performance Characteristics (Continued)

Unless otherwise noted,  $V_{IN} = V_{EN} = 3.6\text{ V}$ ,  $V_{MODE} = 0\text{ V}$  (AUTO Mode),  $V_{OUT} = 1.82\text{ V}$ , and  $T_A = 25^\circ\text{C}$ .

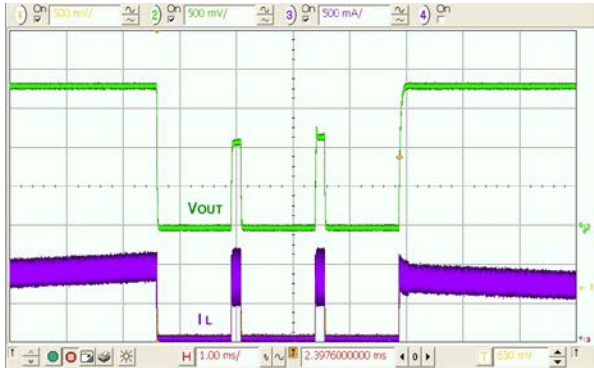

Figure 28. Over-Current, Load Increasing Past Current Limit, FAN53601

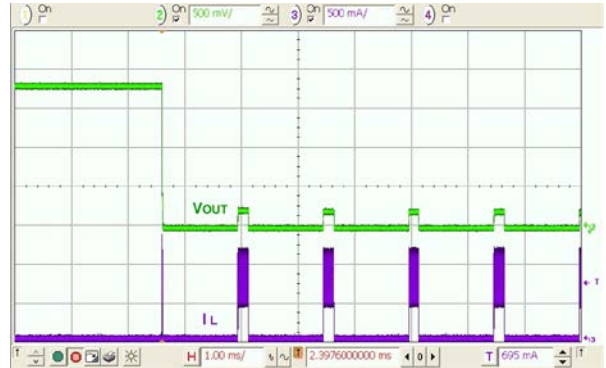

Figure 29. 250 mΩ Fault, Rapid Fault, Hiccup, FAN53601

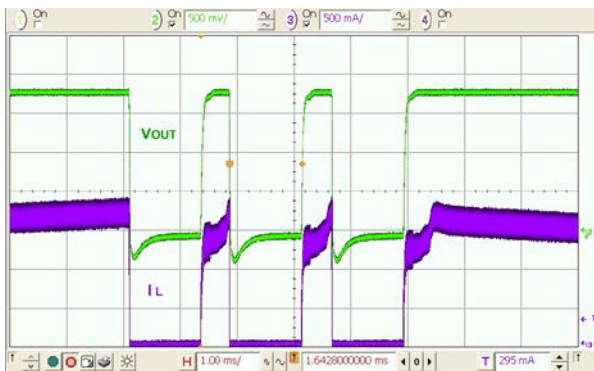

Figure 30. Over-Current, Load Increasing Past Current Limit, FAN53611

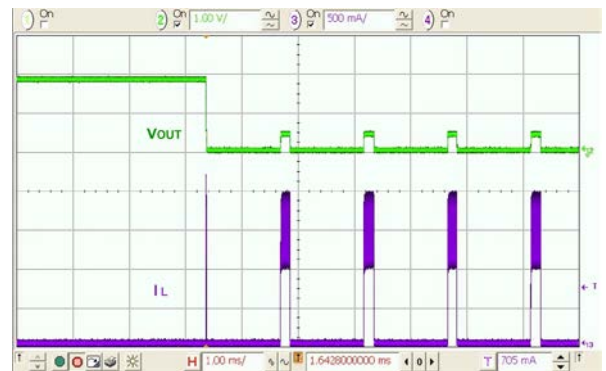

Figure 31. 250 mΩ Fault, Rapid Fault, Hiccup, FAN53611

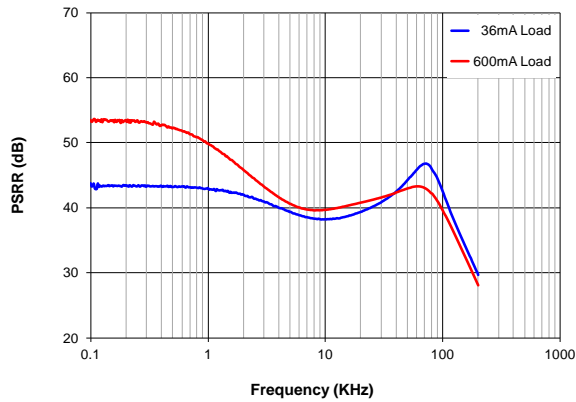

Figure 32. PSRR, 50 Ω and 3 Ω Load

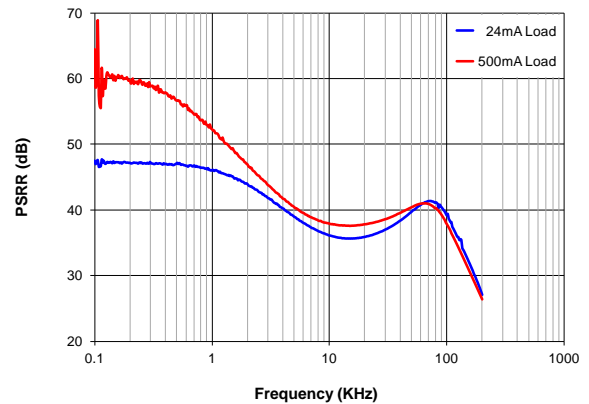

Figure 33. PSRR, 50 Ω and 3 Ω Load,  $V_{OUT} = 1.23\text{ V}$

## Operation Description

The FAN53601/11 is a 6 MHz, step-down switching voltage regulator available in 600 mA or 1 A options that delivers a fixed output from an input voltage supply of 2.3 V to 5.5 V. Using a proprietary architecture with synchronous rectification, the FAN53601/11 is capable of delivering a peak efficiency of 92%, while maintaining efficiency over 80% at load currents as low as 1 mA.

The regulator operates at a nominal fixed frequency of 6 MHz, which reduces the value of the external components to as low as 470 nH for the output inductor and 4.7  $\mu$ F for the output capacitor. In addition, the PWM modulator can be synchronized to an external frequency source.

## Control Scheme

The FAN53601/11 uses a proprietary, non-linear, fixed-frequency PWM modulator to deliver a fast load transient response, while maintaining a constant switching frequency over a wide range of operating conditions. The regulator performance is independent of the output capacitor ESR, allowing for the use of ceramic output capacitors. Although this type of operation normally results in a switching frequency that varies with input voltage and load current, an internal frequency loop holds the switching frequency constant over a large range of input voltages and load currents.

For very light loads, the FAN53601/11 operates in Discontinuous Current Mode (DCM) single-pulse PFM Mode, which produces low output ripple compared with other PFM architectures. Transition between PWM and PFM is seamless, allowing for a smooth transition between DCM and CCM.

Combined with exceptional transient response characteristics, the very low quiescent current of the controller maintains high efficiency; even at very light loads; while preserving fast transient response for applications requiring tight output regulation.

## Enable and Soft-Start

When EN is LOW, all circuits are off and the IC draws ~250 nA of current. When EN is HIGH and  $V_{IN}$  is above its UVLO threshold, the regulator begins a soft-start cycle. The output ramp during soft-start is a fixed slew rate of 50 mV/ $\mu$ s from  $V_{out} = 0$  to 1 V, then 12.5 mV/ $\mu$ s until the output reaches its setpoint. Regardless of the state of the MODE pin, PFM Mode is enabled to prevent current from being discharged from  $C_{OUT}$  if soft-start begins when  $C_{OUT}$  is charged.

In addition, all voltage options can be ordered with a feature that actively discharges FB to ground through a 230  $\Omega$  path when EN is LOW. Raising EN above its threshold voltage activates the part and starts the soft-start cycle. During soft-start, the internal reference is ramped using an exponential RC shape to prevent overshoot of the output voltage. Current limiting minimizes inrush during soft-start.

The current-limit fault response protects the IC in the event of an over-current condition present during soft-start. As a result, the IC may fail to start if heavy load is applied during startup and/or if excessive  $C_{OUT}$  is used.

The current required to charge  $C_{OUT}$  during soft-start commonly referred to as “displacement current” is given as:

$$I_{DISP} = C_{OUT} \cdot \frac{dV}{dt} \quad (1)$$

where  $\frac{dV}{dt}$  refers to the soft-start slew rate.

To prevent shutdown during soft-start, the following condition must be met:

$$I_{DISP} + I_{LOAD} < I_{MAX(DC)} \quad (2)$$

where  $I_{MAX(DC)}$  is the maximum load current the IC is guaranteed to support.

## Startup into Large $C_{OUT}$

Multiple soft-start cycles are required for no-load startup if  $C_{OUT}$  is greater than 15  $\mu$ F. Large  $C_{OUT}$  requires light initial load to ensure the FAN53601/11 starts appropriately. The IC shuts down for 1.3 ms when  $I_{DISP}$  exceeds  $I_{LIMIT}$  for more than 200  $\mu$ s of current limit. The IC then begins a new soft-start cycle. Since  $C_{OUT}$  retains its charge when the IC is off, the IC reaches regulation after multiple soft-start attempts.

## MODE Pin

Logic 1 on this pin forces the IC to stay in PWM Mode. A logic 0 allows the IC to automatically switch to PFM during light loads. If the MODE pin is toggled with a frequency between 1.3 MHz and 1.7 MHz, the converter synchronizes its switching frequency to four times the frequency on the MODE pin.

The MODE pin is internally buffered with a Schmitt trigger, which allows the MODE pin to be driven with slow rise and fall times. An asymmetric duty cycle for frequency synchronization is also permitted as long as the minimum time below  $V_{IL(MAX)}$  or above  $V_{IH(MAX)}$  is 100 ns.

## Current Limit, Fault Shutdown, and Restart

A heavy load or short circuit on the output causes the current in the inductor to increase until a maximum current threshold is reached in the high-side switch. Upon reaching this point, the high-side switch turns off, preventing high currents from causing damage. The regulator continues to limit the current cycle-by-cycle. After 16 cycles of current limit, the regulator triggers an over-current fault, causing the regulator to shutdown for about 1.3 ms before attempting a restart.

If the fault is caused by short circuit, the soft-start circuit attempts to restart and produces an over-current fault after about 200  $\mu$ s, which results in a duty cycle of less than 15%, limiting power dissipation.

The closed-loop peak-current limit is not the same as the open-loop tested current limit,  $I_{LM(OL)}$ , in the Electrical Characteristics table. This is primarily due to the effect of propagation delays of the IC current limit comparator.

## Under-Voltage Lockout (UVLO)

When EN is HIGH, the under-voltage lockout keeps the part from operating until the input supply voltage rises high enough to properly operate. This ensures no misbehavior of the regulator during startup or shutdown.

### Thermal Shutdown (TSD)

When the die temperature increases, due to a high load condition and/or a high ambient temperature; the output switching is disabled until the die temperature falls sufficiently. The junction temperature at which the thermal shutdown activates is nominally 150°C with a 15°C hysteresis.

### Minimum Off-Time Effect on Switching Frequency

$t_{OFF(MIN)}$  is 40 ns. This imposes constraints on the maximum  $\frac{V_{OUT}}{V_{IN}}$  that the FAN53601/11 can provide or the maximum output voltage it can provide at low  $V_{IN}$  while maintaining a fixed switching frequency in PWM Mode.

When  $V_{IN}$  is LOW, fixed switching is maintained as long as:

$$\frac{V_{OUT}}{V_{IN}} \leq 1 - t_{OFF(MIN)} \cdot f_{SW} \approx 0.7.$$

The switching frequency drops when the regulator cannot provide sufficient duty cycle at 6 MHz to maintain regulation. This occurs when  $V_{OUT}$  is 1.82 V and  $V_{IN}$  is below 2.7 V at high load currents (see Figure 34).

The calculation for switching frequency is given by:

$$f_{SW} = \min\left(\frac{1}{t_{SW(MAX)}}, 6MHz\right) \tag{3}$$

where:

$$t_{SW(MAX)} = 40ns \cdot \left(1 + \frac{V_{OUT} + I_{OUT} \cdot R_{OFF}}{V_{IN} - I_{OUT} \cdot R_{ON} - V_{OUT}}\right) \tag{4}$$

where:

$$R_{OFF} = R_{DSON\_N} + DCR_L$$

$$R_{ON} = R_{DSON\_P} + DCR_L$$

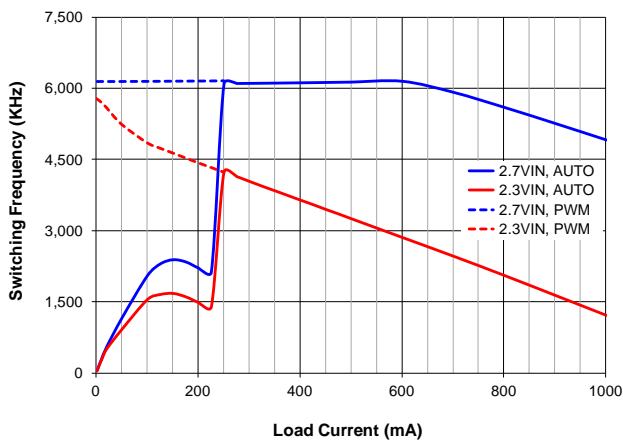

**Figure 34. Frequency vs. Load Current to Demonstrate  $t_{OFF(MIN)}$  Effect,  $V_{IN} = 2.3$  V and 2.7 V,  $V_{OUT} = 1.82$  V, Auto Mode, FPWM Dotted**

## Applications Information

### Selecting the Inductor

The output inductor must meet both the required inductance and the energy-handling capability of the application. The inductor value affects average current limit, the PWM-to-PFM transition point, output voltage ripple, and efficiency.

The ripple current ( $\Delta I$ ) of the regulator is:

$$\Delta I \approx \frac{V_{OUT}}{V_{IN}} \cdot \left( \frac{V_{IN} - V_{OUT}}{L \cdot f_{SW}} \right) \quad (5)$$

The maximum average load current,  $I_{MAX(Load)}$ , is related to the peak current limit,  $I_{LIM(PK)}$ , by the ripple current, given by:

$$I_{MAX(Load)} = I_{LIM(PK)} - \frac{\Delta I}{2} \quad (6)$$

The transition between PFM and PWM operation is determined by the point at which the inductor valley current crosses zero. The regulator DC current when the inductor current crosses zero,  $I_{DCM}$ , is:

$$I_{DCM} = \frac{\Delta I}{2} \quad (7)$$

The FAN53601/11 is optimized for operation with  $L = 470$  nH, but is stable with inductances up to  $1 \mu\text{H}$  (nominal). The inductor should be rated to maintain at least 80% of its value at  $I_{LIM(PK)}$ .

Efficiency is affected by the inductor DCR and inductance value. Decreasing the inductor value for a given physical size typically decreases the DCR; but because  $\Delta I$  increases, the RMS current increases, as do the core and skin effect losses.

$$I_{RMS} = \sqrt{I_{OUT(DC)}^2 + \frac{\Delta I^2}{12}} \quad (8)$$

The increased RMS current produces higher losses through the  $R_{DS(ON)}$  of the IC MOSFETs, as well as the inductor DCR.

Increasing the inductor value produces lower RMS currents, but degrades transient response. For a given physical inductor size, increased inductance usually results in an inductor with lower saturation current and higher DCR.

Table 1 shows the effects of inductance higher or lower than the recommended  $1 \mu\text{H}$  on regulator performance.

### Output Capacitor

Table 2 suggests 0402 capacitors. 0603 capacitors may further improve performance in that the effective capacitance is higher. This improves transient response and output ripple.

Increasing  $C_{OUT}$  has no effect on loop stability and can therefore be increased to reduce output voltage ripple or to improve transient response. Output voltage ripple,  $\Delta V_{OUT}$ , is:

$$\Delta V_{OUT} = \Delta I_L \left[ \frac{f_{SW} \cdot C_{OUT} \cdot ESR^2}{2 \cdot D \cdot (1-D)} + \frac{1}{8 \cdot f_{SW} \cdot C_{OUT}} \right] \quad (9)$$

### Input Capacitor

The  $2.2 \mu\text{F}$  ceramic input capacitor should be placed as close as possible between the  $V_{IN}$  pin and GND to minimize the parasitic inductance. If a long wire is used to bring power to the IC, additional "bulk" capacitance (electrolytic or tantalum) should be placed between  $C_{IN}$  and the power source lead to reduce the ringing that can occur between the inductance of the power source leads and  $C_{IN}$ .

The effective capacitance value decreases as  $V_{IN}$  increases due to DC bias effects.

**Table 1. Effects of Changes in Inductor Value (from 470 nH Recommended Value) on Regulator Performance**

Inductor Value	$I_{MAX(Load)}$	$\Delta V_{OUT}$	Transient Response
Increase	Increase	Decrease	Degraded
Decrease	Decrease	Increase	Improved

**Table 2. Recommended Passive Components and their Variation Due to DC Bias**

Component	Description	Vendor	Min.	Typ.	Max.
L1	470 nH, 2012,90 mΩ, 1.1 A	Murata LQM21PNR47MC0 Murata LQM21PNR54MG0 Hitachi Metals HLSI 201210R47	300 nH	470 nH	520 nH
$C_{IN}$	2.2 $\mu\text{F}$ , 6.3 V, X5R, 0402	Murata or Equivalent GRM155R60J225ME15 GRM188R60J225KE19D	1.0 $\mu\text{F}$	2.2 $\mu\text{F}$	
$C_{OUT}$	4.7 $\mu\text{F}$ , X5R, 0402	Murata or Equivalent GRM155R60G475M GRM155R60E475ME760	1.6 $\mu\text{F}$	4.7 $\mu\text{F}$	

## PCB Layout Guidelines

There are only three external components: the inductor and the input and output capacitors. For any buck switcher IC, including the FAN53601/11, it is important to place a low-ESR input capacitor very close to the IC, as shown in Figure 35. The input capacitor ensures good input decoupling, which helps reduce noise appearing at the output terminals and ensures that the control sections of the IC do not behave

erratically due to excessive noise. This reduces switching cycle jitter and ensures good overall performance. It is important to place the common GND of  $C_{IN}$  and  $C_{OUT}$  as close as possible to the C2 terminal. There is some flexibility in moving the inductor further away from the IC; in that case,  $V_{OUT}$  should be considered at the  $C_{OUT}$  terminal.

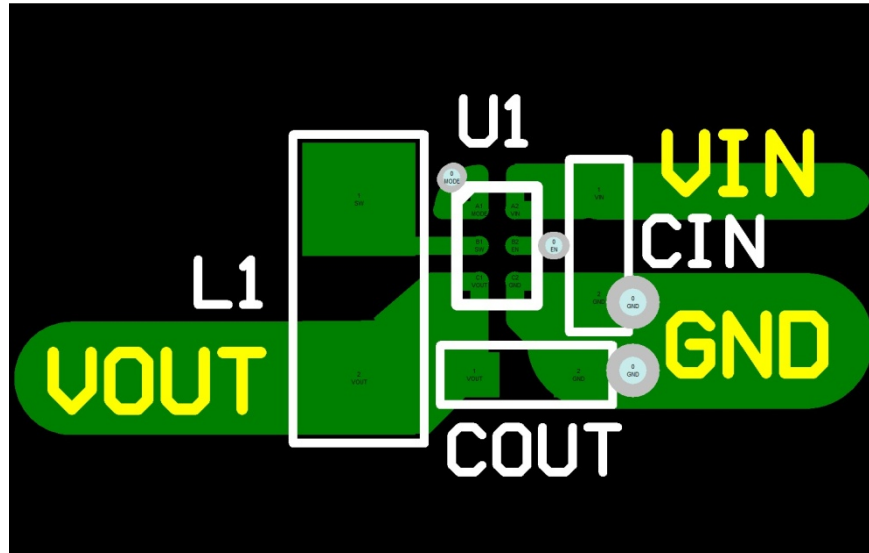

Figure 35. PCB Layout Guidance

The following information applies to the WLCSP package dimensions on the next page:

### Product-Specific Dimensions

D	E	X	Y
1.160 ±0.030	0.860 ±0.030	0.230	0.180

### Physical Dimensions

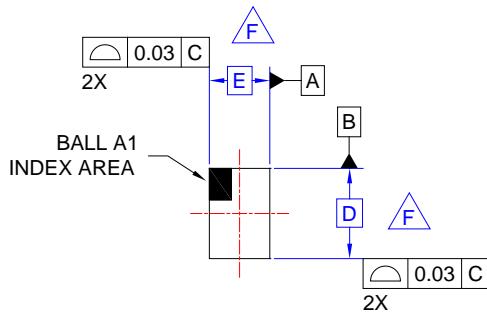

TOP VIEW

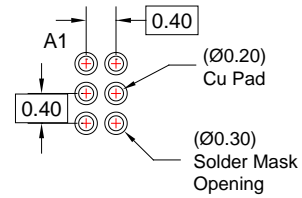

RECOMMENDED LAND PATTERN  
(NSMD PAD TYPE)

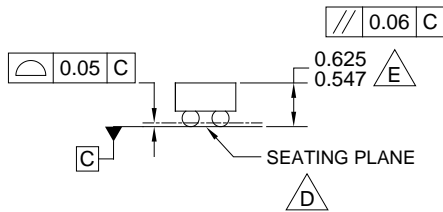

SIDE VIEWS

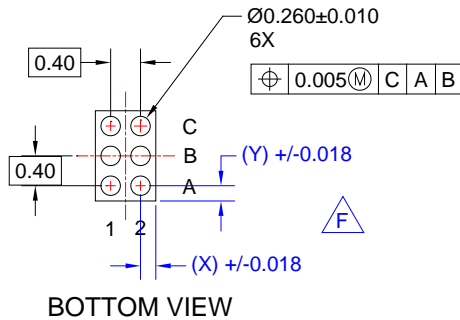

BOTTOM VIEW

#### NOTES:

- A. NO JEDEC REGISTRATION APPLIES.
- B. DIMENSIONS ARE IN MILLIMETERS.
- C. DIMENSIONS AND TOLERANCES PER ASMEY14.5M, 1994.
- D. DATUM C, THE SEATING PLANE IS DEFINED BY THE SPHERICAL CROWNS OF THE BALLS.
- E. PACKAGE TYPICAL HEIGHT IS 586 MICRONS ±39 MICRONS (547-625 MICRONS).
- F. FOR DIMENSIONS D, E, X, AND Y SEE PRODUCT DATASHEET.
- G. DRAWING FILENAME: UC006ACrev4.

Figure 36. 6-Bump WLCSP, 0.4 mm Pitch



ON Semiconductor and the ON Semiconductor logo are trademarks of Semiconductor Components Industries, LLC dba ON Semiconductor or its subsidiaries in the United States and/or other countries. ON Semiconductor owns the rights to a number of patents, trademarks, copyrights, trade secrets, and other intellectual property. A listing of ON Semiconductor's product/patent coverage may be accessed at [www.onsemi.com/site/pdf/PatentMarking.pdf](http://www.onsemi.com/site/pdf/PatentMarking.pdf). ON Semiconductor reserves the right to make changes without further notice to any products herein. ON Semiconductor makes no warranty, representation or guarantee regarding the suitability of its products for any particular purpose, nor does ON Semiconductor assume any liability arising out of the application or use of any product or circuit, and specifically disclaims any and all liability, including without limitation special, consequential or incidental damages. Buyer is responsible for its products and applications using ON Semiconductor products, including compliance with all laws, regulations and safety requirements or standards, regardless of any support or applications information provided by ON Semiconductor. "Typical" parameters which may be provided in ON Semiconductor data sheets and/or specifications can and do vary in different applications and actual performance may vary over time. All operating parameters, including "Typicals" must be validated for each customer application by customer's technical experts. ON Semiconductor does not convey any license under its patent rights nor the rights of others. ON Semiconductor products are not designed, intended, or authorized for use as a critical component in life support systems or any FDA Class 3 medical devices or medical devices with a same or similar classification in a foreign jurisdiction or any devices intended for implantation in the human body. Should Buyer purchase or use ON Semiconductor products for any such unintended or unauthorized application, Buyer shall indemnify and hold ON Semiconductor and its officers, employees, subsidiaries, affiliates, and distributors harmless against all claims, costs, damages, and expenses, and reasonable attorney fees arising out of, directly or indirectly, any claim of personal injury or death associated with such unintended or unauthorized use, even if such claim alleges that ON Semiconductor was negligent regarding the design or manufacture of the part. ON Semiconductor is an Equal Opportunity/Affirmative Action Employer. This literature is subject to all applicable copyright laws and is not for resale in any manner.

## PUBLICATION ORDERING INFORMATION

### LITERATURE FULFILLMENT:

Literature Distribution Center for ON Semiconductor  
19521 E. 32nd Pkwy, Aurora, Colorado 80011 USA  
Phone: 303-675-2175 or 800-344-3860 Toll Free USA/Canada  
Fax: 303-675-2176 or 800-344-3867 Toll Free USA/Canada  
Email: [orderlit@onsemi.com](mailto:orderlit@onsemi.com)

**N. American Technical Support:** 800-282-9855 Toll Free  
USA/Canada.  
**Europe, Middle East and Africa Technical Support:**  
Phone: 421 33 790 2910  
**Japan Customer Focus Center**  
Phone: 81-3-5817-1050

**ON Semiconductor Website:** [www.onsemi.com](http://www.onsemi.com)  
**Order Literature:** <http://www.onsemi.com/orderlit>

For additional information, please contact your local  
Sales Representative

# Mouser Electronics

Authorized Distributor

Click to View Pricing, Inventory, Delivery & Lifecycle Information:

[onsemi:](#)

[FAN53601UC182X](#) [FAN53611UC123X](#) [FAN53611AUC11X](#) [FAN53611AUC13X](#) [FAN53601AUC10X](#)  
[FAN53611AUC135X](#) [FAN53611AUC115X](#) [FAN53601AUC105X](#) [FAN53611AUC123X](#) [FAN53611AUC12X](#)  
[FAN53611AUC18X](#) [FAN53611AUC205X](#)