

Mitutoyo

Digital ABS Caliper Nib Style/Std. Jaws

0-1000mm

Item number: 551-207-10



Description

This is a Digimatic caliper with nib-style and standard jaws. It offers you the following benefits:

- Knife-shaped measuring surfaces allow you to take outside measurements.
- Rounded measuring surfaces enable you to measure inside dimensions.
- ABSOLUTE System delivers reliable measurements.

Features

Inside measuring from:	20.1 mm
Max. Permissible Error E MPE:	±0,07 mm
Max. Permissible Error S MPE:	±0,07 mm
Mass:	3430 g
Max. response speed:	Unlimited
OFFSET:	10 mm
Battery life:	Approx. 5 years, 3,5 years (>300 mm)
ORIGIN (ABS-Zero):	Yes
ON/OFF:	Yes
Low voltage alarm:	Yes
Data output:	Yes



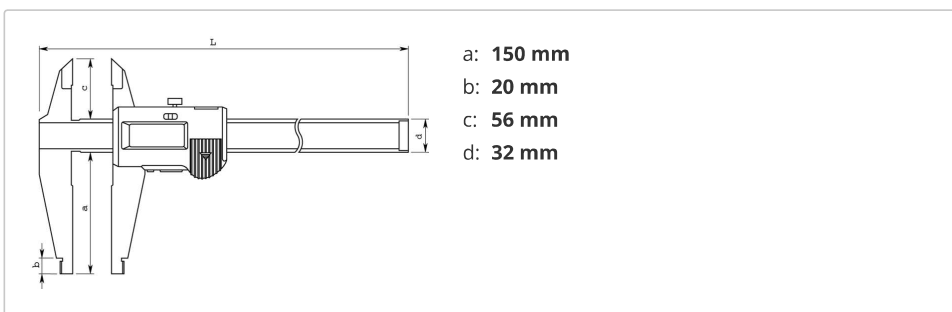

Dimensions



Accessories

Standard accessories:



	Suggested retail price: 43.00 €*
	Digimatic Cable, Straight, Data Button, 2m 959150 Suggested retail price: 50.00 €*
	U-WAVE-T Connection Cable C Straight, with Data Button 02AZD790C Suggested retail price: 93.00 €*
	USB Input Tool Direct (Digimatic USB) Digi/Digi2, Straight, with Data Button 06ADV380C Suggested retail price: 104.00 €*
	USB Input Tool Direct (Digimatic USB) Digi/Digi2, Straight, with Data Button 06AFM380C Suggested retail price: 109.00 €*

Spare parts

Consumable spares:	
	Battery SR44 1.5V 938882