

REVISIONS					
P	LTR	DESCRIPTION	DATE	DWN	APVD
	BA2	ECR-17-013465	13SEP2017	RK	TN

NOTES:

- FOR FURTHER INFORMATION SEE DATA SHEET FOR C SERIES-HIGH POWER RESISTORS.
- WEIGHT 0.600 Kg PER 100 PIECES.

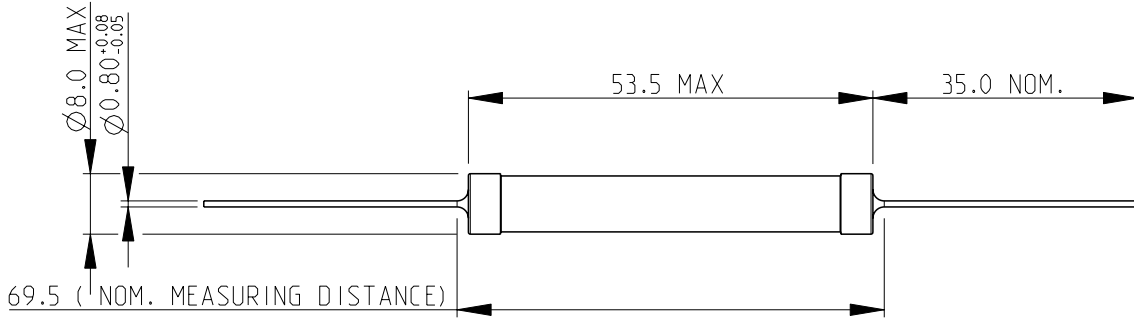

RoHS Compliant

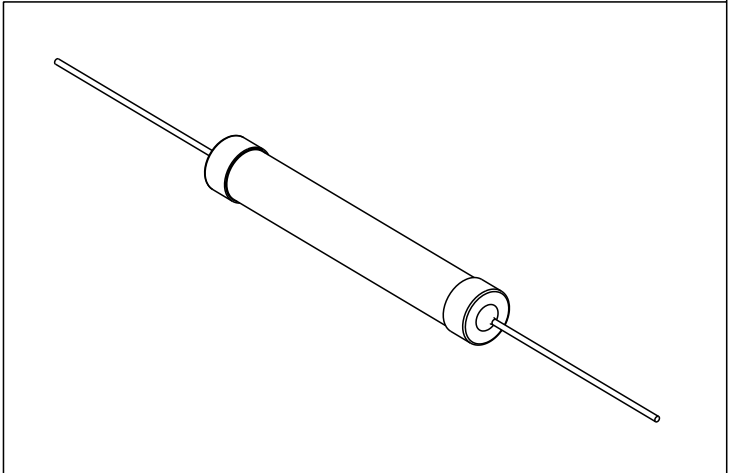

2008

RELEASED FOR PUBLICATION

THIS DRAWING IS UNPUBLISHED.

ALL RIGHTS RESERVED.

BY -

© COPYRIGHT 2008



DIMENSIONS:		DWN	16-Sep-08	MATERIAL	-	FINISH	-
mm		CHK	16-Sep-08				
TOLERANCES UNLESS OTHERWISE SPECIFIED:		APVD	16-Sep-08				
0 PLC	±0.2	STEPHEN.P		NAME HIGH POWER RESISTORS			
1 PLC	±0.1	PRODUCT SPEC	-	SERIES C14			
2 PLC	±	APPLICATION SPEC	-	SIZE	CAGE CODE	DRAWING NO	RESTRICTED TO
3 PLC	±	WEIGHT	-	A 4	00779	C=1623774	-
4 PLC	±	CUSTOMER DRAWING					
ANGLES	±5°			SCALE	1:1	SHEET	1 OF 1
						REV	BA2

Mouser Electronics

Authorized Distributor

Click to View Pricing, Inventory, Delivery & Lifecycle Information:

[TE Connectivity:](#)

[C1422RJL](#)