

INTERCONNECTS

SERIES 830, 831, 832, 833 • 2mm GRID HEADERS AND SOCKETS • SINGLE AND DOUBLE ROW STRIPS

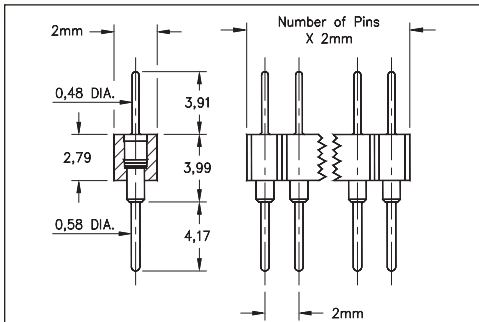

FIG. 1

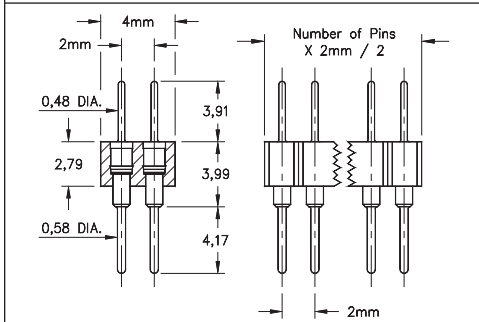

FIG. 2

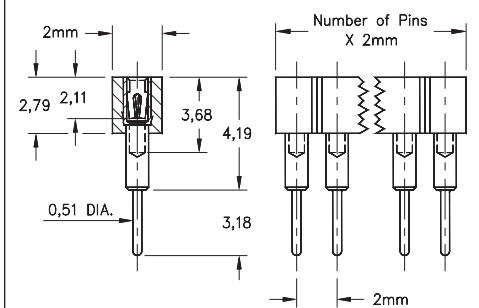

FIG. 3

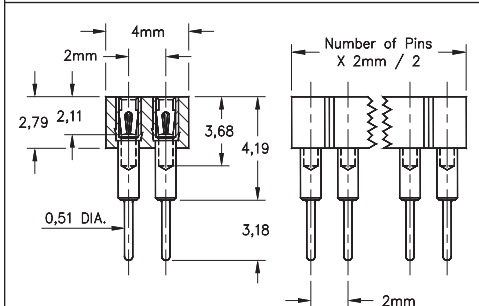
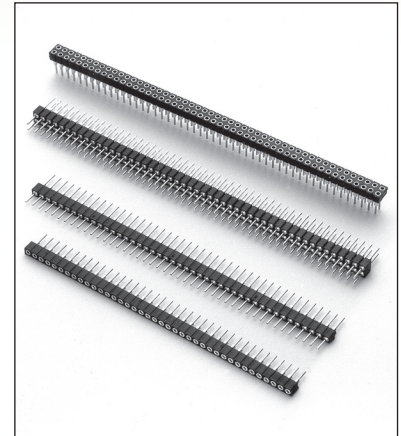

FIG. 4

- Series 830 single & double row interconnects have 2mm pin spacing and permit board stacking as low as 8,18
- Pin headers (830 & 832 series) use MM #5012 pins. See page 208 for details
- Sockets (831 & 833 series) use MM #1802 receptacles and accept pin diameters from 0,38 - 0,64. See page 169 for details
- Contact is rated at 3 amps
- Insulators are high temperature thermoplastic, suitable for all soldering operations



ORDERING INFORMATION









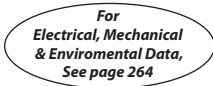



FIG. 1	Series 830...001	Single Row Pin Header		
	830-XX-0	-10-001000	Specify number of pins → 01-50	
FIG. 2	Series 832...001	Double Row Pin Header		
	832-XX-	-10-001000	Specify number of pins → 002-100	
  				
SPECIFY PLATING CODE XX=				
Pin Plating 				
	10 	90	40 	
	0,25µm Au	5,08µm Sn/Pb	5,08µm Sn	

FIG. 3	Series 831...001	Single Row Socket			
	831-XX-0	-10-001000	Specify number of pins → 01-50		
FIG. 4	Series 833...001	Double Row Socket			
	833-XX-	-10-001000	Specify number of pins → 002-100		
  					
SPECIFY PLATING CODE XX=					
Sleeve (Pin) 					
Contact (Clip) 					
	91	93	41 	43 	
	5,08µm Sn/Pb	5,08µm Sn/Pb	5,08µm Sn	5,08µm Sn	
	0,25µm Au	0,76µm Au	0,25µm Au	0,76µm Au	

Mouser Electronics

Authorized Distributor

Click to View Pricing, Inventory, Delivery & Lifecycle Information:

Mill-Max:

[833-43-046-10-001000](#) [833-43-050-10-001000](#) [833-43-054-10-001000](#) [832-10-020-10-001000](#) [833-43-044-10-001000](#) [833-43-048-10-001000](#) [833-43-052-10-001000](#) [832-10-034-10-001000](#) [833-43-028-10-001000](#) [833-41-012-10-001000](#) [833-41-046-10-001000](#) [833-41-062-10-001000](#) [833-41-070-10-001000](#) [833-41-080-10-001000](#) [833-41-088-10-001000](#) [833-43-020-10-001000](#) [833-41-032-10-001000](#) [833-41-042-10-001000](#) [833-41-050-10-001000](#) [833-41-058-10-001000](#) [833-41-084-10-001000](#) [833-43-010-10-001000](#) [833-43-014-10-001000](#) [833-43-018-10-001000](#) [833-43-022-10-001000](#) [833-41-014-10-001000](#) [833-41-030-10-001000](#) [833-41-072-10-001000](#) [833-43-034-10-001000](#) [833-93-024-10-001000](#) [833-93-042-10-001000](#) [833-93-066-10-001000](#) [833-41-040-10-001000](#) [833-41-048-10-001000](#) [833-41-056-10-001000](#) [833-41-098-10-001000](#) [833-43-030-10-001000](#) [833-93-068-10-001000](#) [833-93-084-10-001000](#) [833-41-004-10-001000](#) [833-41-054-10-001000](#) [833-41-078-10-001000](#) [833-43-024-10-001000](#) [833-41-002-10-001000](#) [833-41-018-10-001000](#) [833-41-026-10-001000](#) [833-41-036-10-001000](#) [833-41-044-10-001000](#) [833-41-052-10-001000](#) [833-93-008-10-001000](#) [833-93-060-10-001000](#) [833-93-076-10-001000](#) [833-93-058-10-001000](#) [833-93-074-10-001000](#) [833-93-082-10-001000](#) [833-41-006-10-001000](#) [833-41-022-10-001000](#) [833-41-064-10-001000](#) [833-41-082-10-001000](#) [833-41-090-10-001000](#) [833-43-038-10-001000](#) [833-43-042-10-001000](#) [833-91-100-10-001000](#) [833-93-016-10-001000](#) [833-93-026-10-001000](#) [833-93-052-10-001000](#) [833-93-092-10-001000](#) [833-41-020-10-001000](#) [833-41-028-10-001000](#) [833-41-038-10-001000](#) [833-41-096-10-001000](#) [833-43-004-10-001000](#) [833-43-008-10-001000](#) [833-43-016-10-001000](#) [833-43-096-10-001000](#) [833-91-026-10-001000](#) [833-91-036-10-001000](#) [833-91-094-10-001000](#) [833-93-028-10-001000](#) [833-93-036-10-001000](#) [833-93-062-10-001000](#) [833-93-086-10-001000](#) [833-93-094-10-001000](#) [833-41-060-10-001000](#) [833-41-068-10-001000](#) [833-41-076-10-001000](#) [833-41-094-10-001000](#) [833-43-002-10-001000](#) [833-93-038-10-001000](#) [833-93-056-10-001000](#) [833-93-072-10-001000](#) [833-41-086-10-001000](#) [833-43-032-10-001000](#) [833-43-036-10-001000](#) [833-43-068-10-001000](#) [833-43-072-10-001000](#) [833-91-038-10-001000](#) [833-91-062-10-001000](#) [833-91-080-10-001000](#) [833-91-088-10-001000](#)