

Feed-through header - MSTB 2,5/ 4-G-5,08 - 1759033

Please be informed that the data shown in this PDF Document is generated from our Online Catalog. Please find the complete data in the user's documentation. Our General Terms of Use for Downloads are valid (<http://phoenixcontact.com/download>)

PCB headers, nominal current: 12 A, rated voltage (III/2): 320 V, Nominal cross section: 2.5 mm², number of positions: 4, pitch: 5.08 mm, color: green, contact surface: Tin, mounting: Wave soldering, Pin layout: Linear pinning, solder pin [P]: 3.5 mm



The figure shows a 10-position version of the product

Your advantages

- ✓ Maximum flexibility when it comes to device design – one header for connectors with different connection technologies
- ✓ Easy PCB replacement thanks to plug-in modules
- ✓ Well-known mounting principle allows worldwide use
- ✓ Plug-in direction parallel to the PCB
- ✓ Items that can be aligned in various pitches support flexible and space-saving PCB assembly



Key Commercial Data

Packing unit	1 pc
Minimum order quantity	250 pc
GTIN	 4 017918 030506
GTIN	4017918030506
Weight per Piece (excluding packing)	1.880 g
Custom tariff number	85366930
Country of origin	Germany

Technical data

Item properties

Brief article description	Feed-through header
Plug-in system	CLASSIC COMBICON
Type of contact	Male connector

Feed-through header - MSTB 2,5/ 4-G-5,08 - 1759033

Technical data

Item properties

Range of articles	MSTB 2,5/..-G
Pitch	5.08 mm
Number of positions	4
Mounting type	Wave soldering
Pin layout	Linear pinning
Locking	without
Number of levels	1
Number of connections	4
Number of potentials	4

Material data - contact

Note	WEEE/RoHS-compliant, free of whiskers according to IEC 60068-2-82/ JEDEC JESD 201
Contact material	Cu alloy
Surface characteristics	Tin-plated
Metal surface contact area (top layer)	Tin (3 - 5 µm Sn)
Metal surface contact area (middle layer)	Nickel (1.3 - 3 µm Ni),
Metal surface soldering area (top layer)	Tin (3 - 5 µm Sn)
Metal surface soldering area (middle layer)	Nickel (1.3 - 3 µm Ni)

Material data - housing

Insulating material	PA
Insulating material group	I
CTI according to IEC 60112	600
Flammability rating according to UL 94	V0
Glow wire flammability index GWFI according to EN 60695-2-12	850
Glow wire ignition temperature GWIT according to EN 60695-2-13	775
Temperature for the ball pressure test according to EN 60695-10-2	125 °C

Dimensions for the product

Length [l]	12 mm
Width [w]	20.32 mm
Height [h]	12.1 mm
Pitch	5.08 mm
Height (without solder pin)	8.6 mm
Solder pin [P]	3.5 mm
Pin dimensions	1 x 1 mm
Dimension a	15.24 mm

Dimensions for PCB design

Feed-through header - MSTB 2,5/ 4-G-5,08 - 1759033

Technical data

Dimensions for PCB design

Hole diameter	1.4 mm
---------------	--------

Packaging information

Type of packaging	packed in cardboard
Pieces per package	250
Denomination packing units	Pcs.

Ambient conditions

Ambient temperature (storage/transport)	-40 °C ... 70 °C
Ambient temperature (assembly)	-5 °C ... 100 °C
Ambient temperature (operation)	-40 °C ... 100 °C (dependent on the derating curve)

Air clearances and creepage distances

Specification	IEC 60664-1:2007-04
Rated insulation voltage (III/3)	320 V
Rated insulation voltage (III/2)	320 V
Rated insulation voltage (II/2)	630 V
Rated surge voltage (III/3)	4 kV
Rated surge voltage (III/2)	4 kV
Rated surge voltage (II/2)	4 kV
Minimum clearance - inhomogeneous field (III/3)	3 mm
Minimum clearance - inhomogeneous field (III/2)	3 mm
Minimum clearance - inhomogeneous field (II/2)	3 mm
Minimum creepage distance value (III/3)	4 mm
Minimum creepage distance value (III/2)	3 mm
Minimum creepage distance value (II/2)	3.2 mm

Mechanical tests (A)

Insertion strength per pos. approx.	8 N
Withdraw strength per pos. approx.	6 N
Polarization when inserted requirement >20 N	Test passed
Contact holder in insert requirements >20 N	Test passed

Durability tests (B)

Specification	IEC 60512-9-1:2010-03
Contact resistance R ₁	1.4 mΩ
Insertion/withdrawal cycles	25
Contact resistance R ₂	1.4 mΩ
Impulse withstand voltage at sea level	4.8 kV
Power-frequency withstand voltage	2.21 kV

Feed-through header - MSTB 2,5/ 4-G-5,08 - 1759033

Technical data

Durability tests (B)

Insulation resistance, neighboring positions	> 0.3 TΩ
--	----------

Climatic tests (D)

Specification	ISO 6988:1985-02
Cold stress	-40 °C/2 h
Thermal stress	100 °C/168 h
Corrosive stress	0.2 dm ³ SO ₂ on 300 dm ³ /40 °C/1 cycle
Impulse withstand voltage at sea level	4.8 kV
Power-frequency withstand voltage	2.21 kV

Environmental and durability tests (E)

Specification	IEC 61984:2008-10
Result, degree of protection, IP code	Finger safety with IP20 test finger

Vibration test

Specification	IEC 60068-2-6:2007-12
Result	Test passed
Frequency	10 - 150 - 10 Hz
Sweep speed	1 octave/min
Amplitude	0.35 mm (10 - 60.1 Hz)
Acceleration	5 g (60.1 - 150 Hz)
Test duration per axis	2.5 h

Standards and Regulations

Connection in acc. with standard	EN-VDE
	CSA
Flammability rating according to UL 94	V0

Environmental Product Compliance

China RoHS	Environmentally friendly use period: unlimited = EFUP-e
	No hazardous substances above threshold values

Drawings

Feed-through header - MSTB 2,5/ 4-G-5,08 - 1759033

Diagram

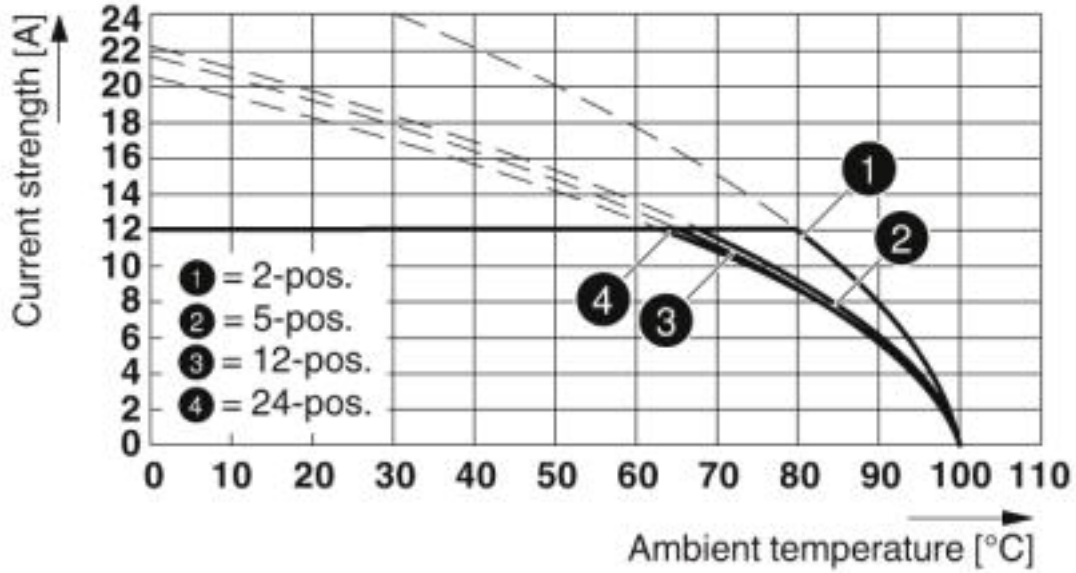

Type: MSTB 2,5/...-ST-5,08 with MSTB 2,5/...-G-5,08

Diagram

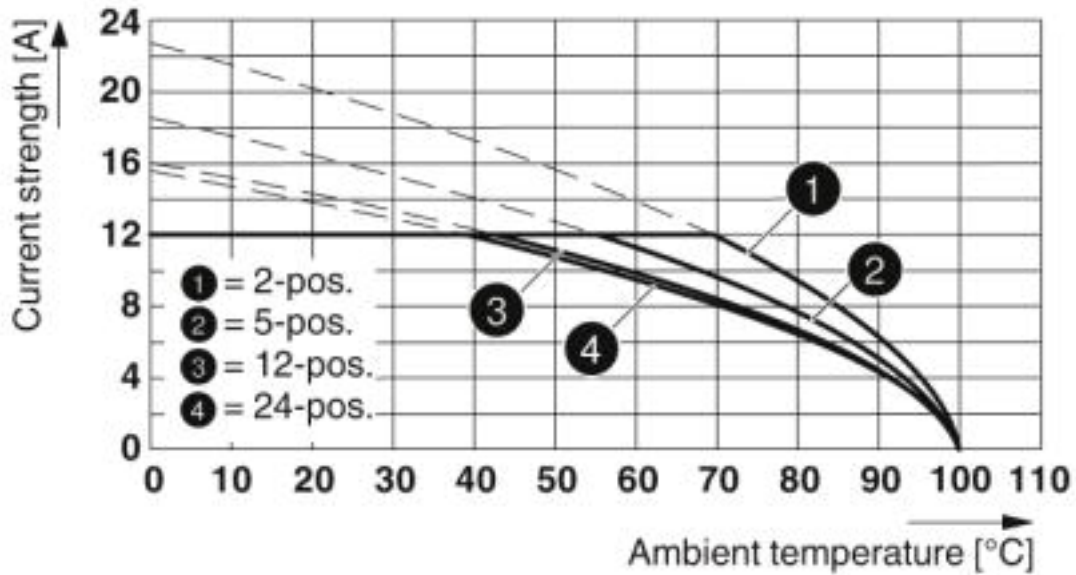

Type: MSTBU 2,5/...-STD-5,08 with MSTB 2,5/...-G-5,08

Feed-through header - MSTB 2,5/ 4-G-5,08 - 1759033

Diagram

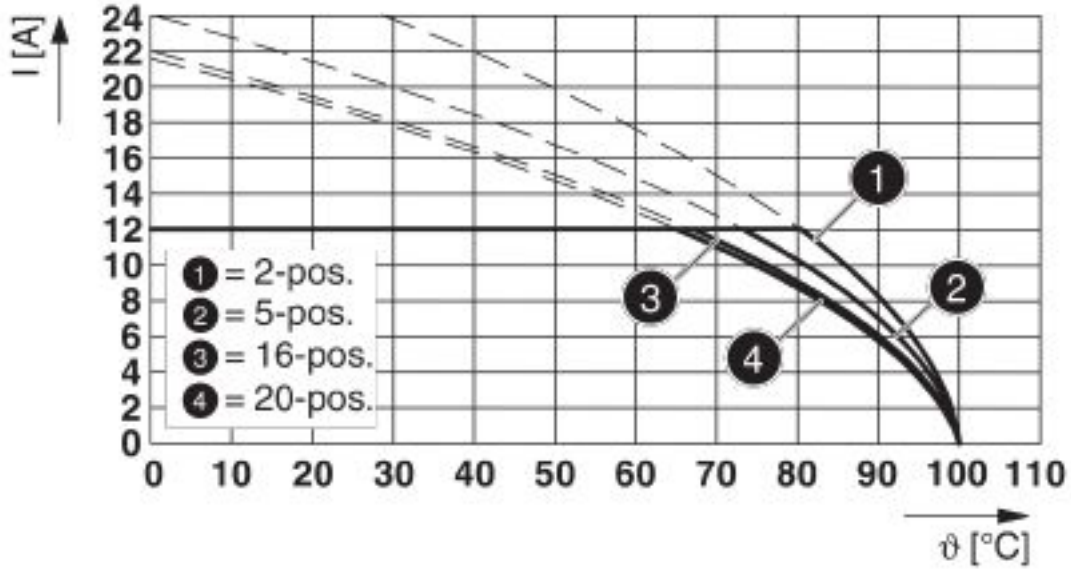

Type: FKCT 2,5/...-ST-5,08 with MSTB 2,5/...-G-5,08

Diagram

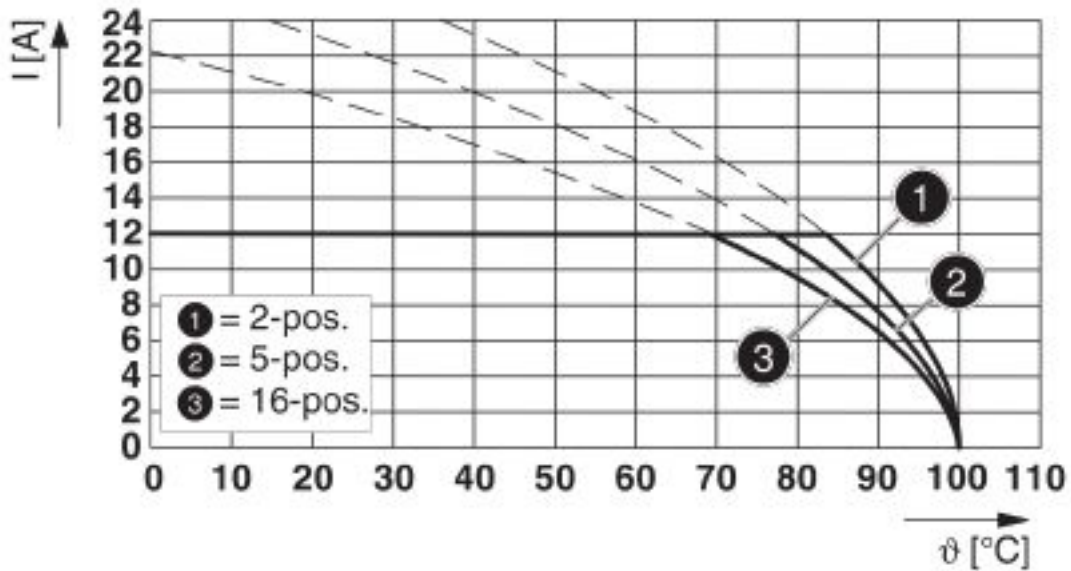

Type: FKCV(W/R) 2,5/...-ST-5,08 with MSTB 2,5/...-G-5,08

Feed-through header - MSTB 2,5/ 4-G-5,08 - 1759033

Diagram

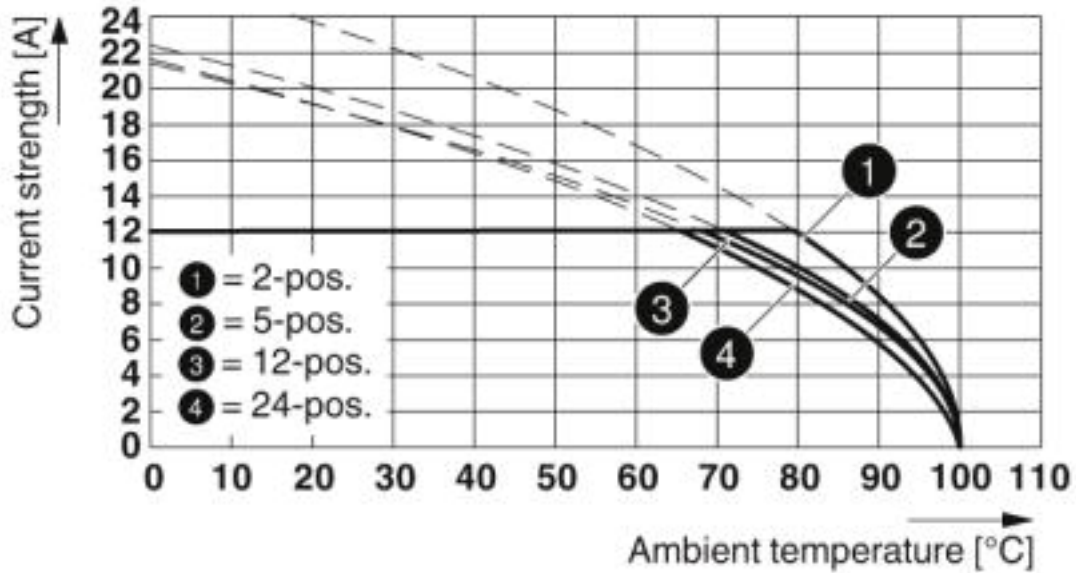

Type: MSTBP 2,5/...-ST-5,08 with MSTB 2,5/...-G-5,08

Diagram

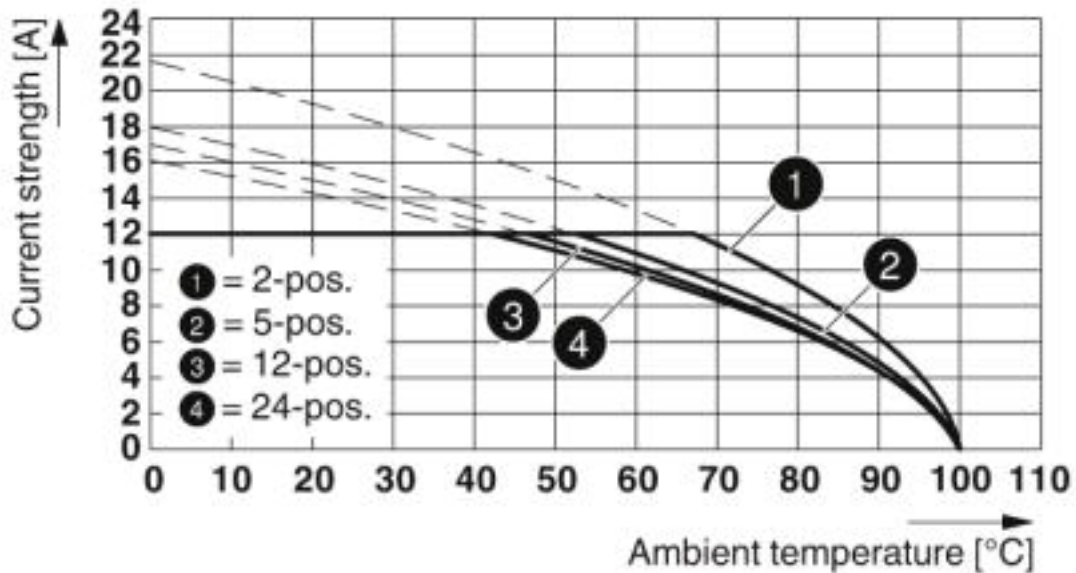

Type: SMSTB 2,5/...-ST-5,08 with MSTB 2,5/...-G-5,08

Feed-through header - MSTB 2,5/ 4-G-5,08 - 1759033

Diagram

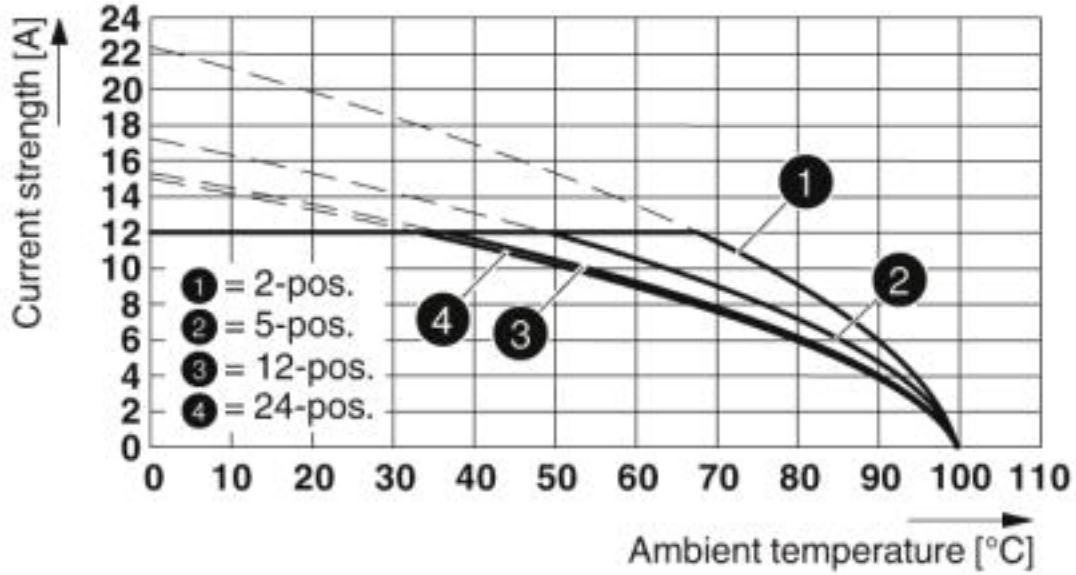

Type: MVSTB(R/W) 2,5/...-ST with MDSTBVA 2,5/...-G-5,08

Diagram

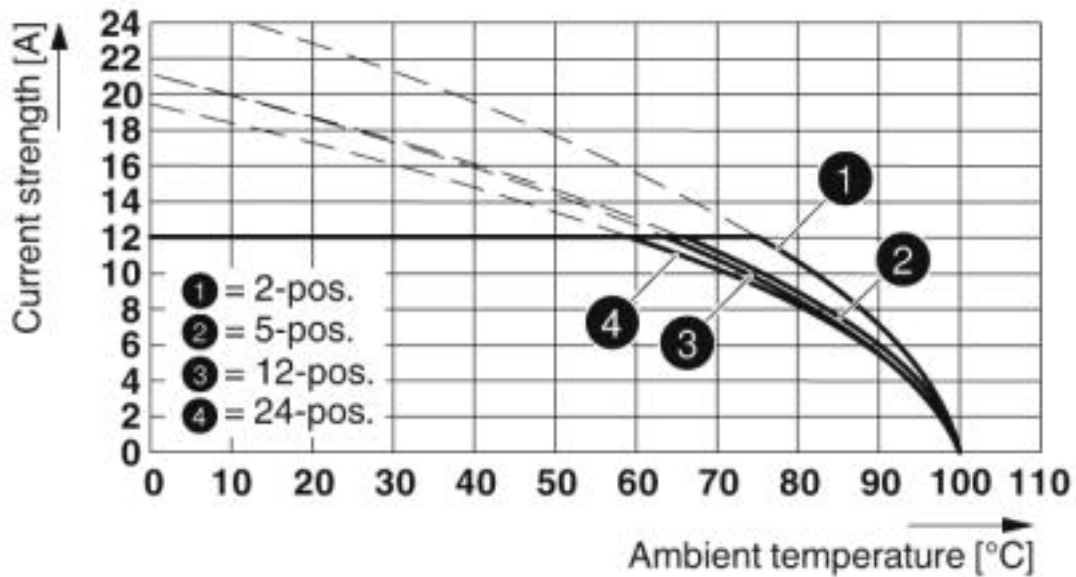

Type: FRONT-MSTB 2,5/...-ST-5,08 with MSTB 2,5/...-G-5,08

Feed-through header - MSTB 2,5/ 4-G-5,08 - 1759033

Diagram

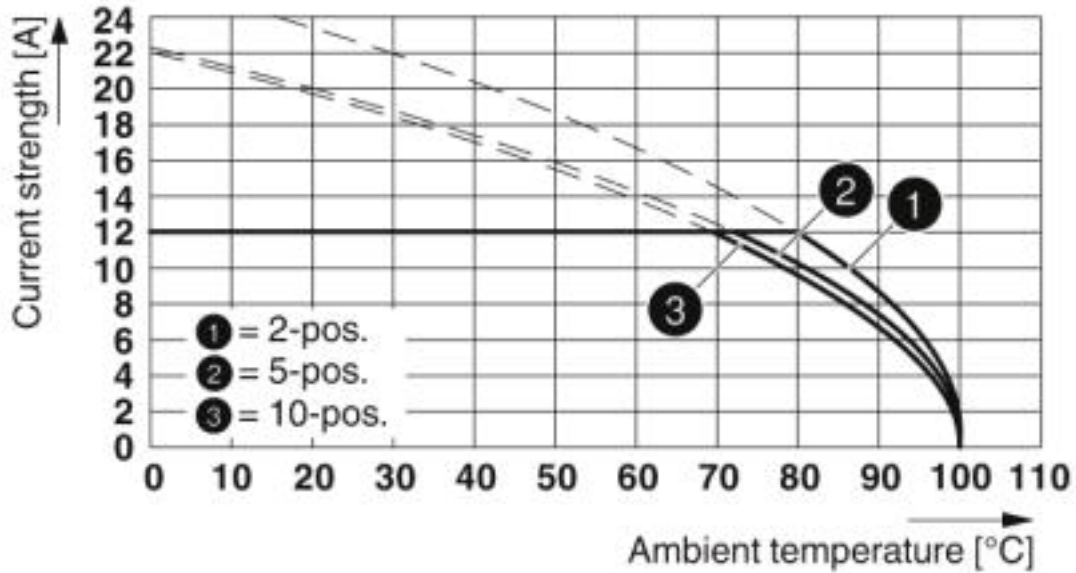

Type: TMSTBP 2,5/...-ST-5,08 with MSTB 2,5/...-G-5,08

Diagram

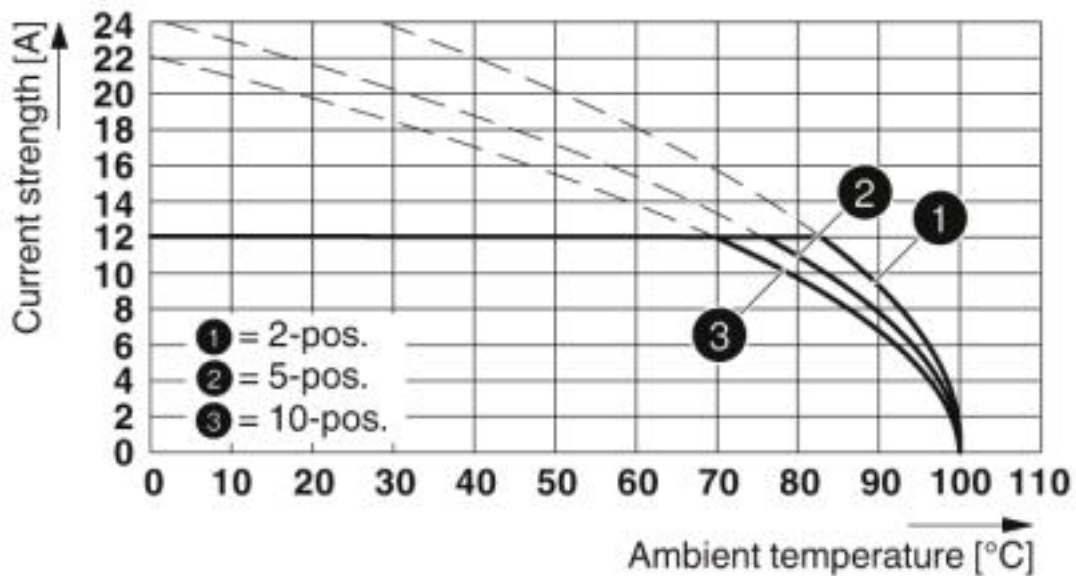

Type: TVMSTB 2,5/...-ST-5,08 with MSTB 2,5/...-G-5,08

Feed-through header - MSTB 2,5/ 4-G-5,08 - 1759033

Diagram

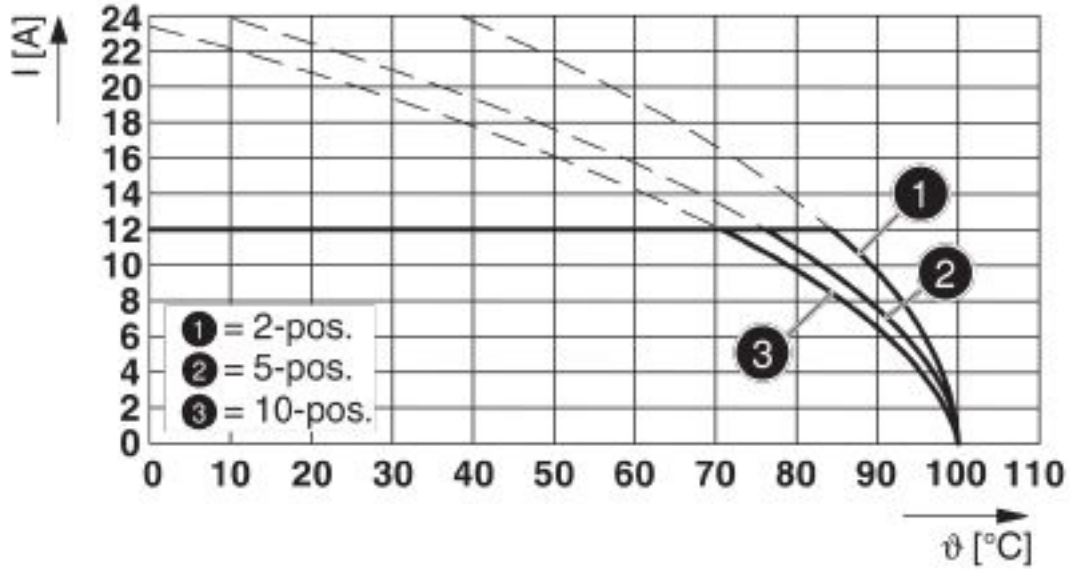

Type: TFKC 2,5/...-ST-5,08 with MSTB 2,5/...-G-5,08

Dimensional drawing

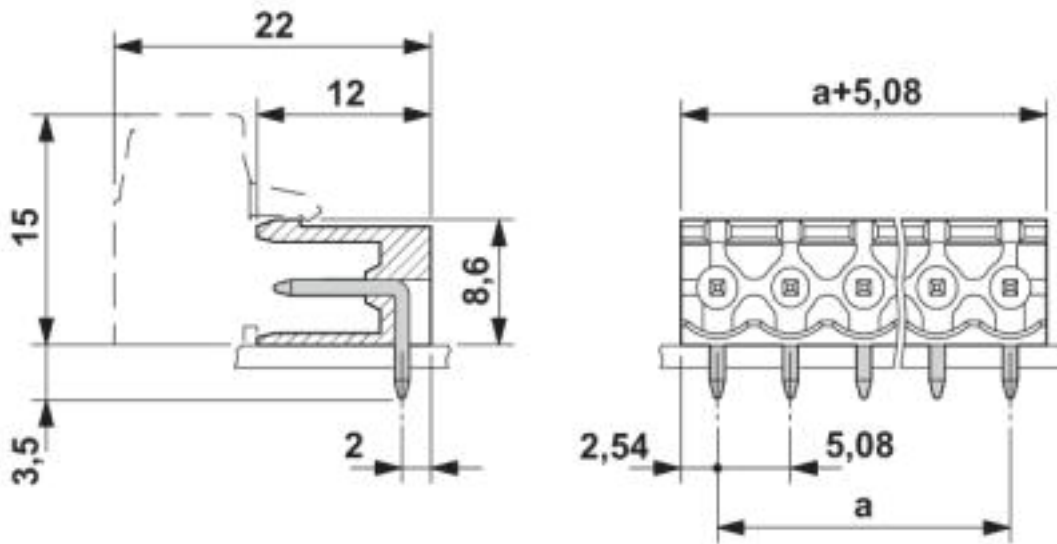

Classifications

eCl@ss

eCl@ss 4.0	27260700
------------	----------

Feed-through header - MSTB 2,5/ 4-G-5,08 - 1759033

Classifications

eCl@ss

eCl@ss 4.1	27260700
eCl@ss 5.0	27260700
eCl@ss 5.1	27260700
eCl@ss 6.0	27260700
eCl@ss 7.0	27440402
eCl@ss 8.0	27440402
eCl@ss 9.0	27440402

ETIM

ETIM 3.0	EC001121
ETIM 4.0	EC002637
ETIM 5.0	EC002637
ETIM 6.0	EC002637
ETIM 7.0	EC002637

UNSPSC

UNSPSC 6.01	30211810
UNSPSC 7.0901	39121409
UNSPSC 11	39121409
UNSPSC 12.01	39121409
UNSPSC 13.2	39121409

Approvals

Approvals

Approvals

CSA / IECCEB CB Scheme / VDE Gutachten mit Fertigungsüberwachung / EAC / cULus Recognized

Ex Approvals

Approval details

Feed-through header - MSTB 2,5/ 4-G-5,08 - 1759033

Approvals

CSA		http://www.csagroup.org/services-industries/product-listing/	13631
	B	D	
Nominal voltage UN	300 V	300 V	
Nominal current IN	10 A	10 A	

IECEE CB Scheme		http://www.iecee.org/	DE1-60988-B1B2
Nominal voltage UN	250 V		
Nominal current IN	12 A		

VDE Gutachten mit Fertigungsüberwachung		http://www2.vde.com/de/Institut/Online-Service/VDE-gepruefteProdukte/Seiten/Online-Suche.aspx	40004701
Nominal voltage UN	250 V		
Nominal current IN	12 A		

EAC			B.01742
-----	---	--	---------

cULus Recognized		http://database.ul.com/cgi-bin/XYV/template/LISEXT/1FRAME/index.htm	E60425-19931011
	B	D	
Nominal voltage UN	300 V	150 V	
Nominal current IN	15 A	15 A	

Accessories

Accessories

Coding element

Feed-through header - MSTB 2,5/ 4-G-5,08 - 1759033

Accessories

Coding section - CR-MSTB - 1734401



Coding section, inserted into the recess in the header or the inverted plug, red insulating material

Filler plug

Accessories - MSTB-BL - 1755477



Keying cap, for forming sections, plugs onto header pin, green insulating material

Flange

Accessories - MSTB-BF - 1759981



Mounting flange, for fixing both ends of the header onto the PCB, green insulating material, with M 2 x 14 screws and nuts.

Labeled terminal marker

Marker card - SK 5,08/3,8:FORTL.ZAHLEN - 0804293



Marker card, Card, white, labeled, Horizontal: consecutive numbers 1 ... 10, 11 ... 20, etc. up to 91 ... (99)100, mounting type: adhesive, for terminal block width: 5.08 mm, lettering field size: 5.08 x 3.8 mm

Marker pen

Feed-through header - MSTB 2,5/ 4-G-5,08 - 1759033

Accessories

Marker pen - B-STIFT - 1051993



Marker pen, for manual labeling of unprinted Zack strips, smear-proof and waterproof, line thickness 0.5 mm

Terminal marking

Marker card - SK 5,08/3,8:UNBEDRUCKT - 0805412



Marker card, Card, white, unlabeled, can be labeled with: Marker pen, mounting type: adhesive, for terminal block width: 5.08 mm, lettering field size: 5.08 x 3.8 mm

Additional products

Printed-circuit board connector - TVMSTB 2,5/ 4-ST-5,08 - 1719024



PCB connector, nominal current: 12 A, rated voltage (III/2): 400 V, Nominal cross section: 2.5 mm², number of positions: 4, pitch: 5.08 mm, connection method: Screw connection with tension sleeve, color: green, contact surface: Tin

Printed-circuit board connector - FKCN 2,5/ 4-ST-5,08 - 1754584



PCB connector, nominal current: 12 A, rated voltage (III/2): 320 V, Nominal cross section: 2.5 mm², number of positions: 4, pitch: 5.08 mm, connection method: Push-in spring connection, color: green, contact surface: Tin

Printed-circuit board connector - MSTB 2,5/ 4-ST-5,08 - 1757035



PCB connector, nominal current: 12 A, rated voltage (III/2): 320 V, Nominal cross section: 2.5 mm², number of positions: 4, pitch: 5.08 mm, connection method: Screw connection with tension sleeve, color: green, contact surface: Tin

Feed-through header - MSTB 2,5/ 4-G-5,08 - 1759033

Accessories

Printed-circuit board connector - MSTBP 2,5/ 4-ST-5,08 - 1769036



PCB connector, nominal current: 12 A, rated voltage (III/2): 320 V, Nominal cross section: 2.5 mm², number of positions: 4, pitch: 5.08 mm, connection method: Screw connection with tension sleeve, color: green, contact surface: Tin

Printed-circuit board connector - MSTB 2,5/ 4-STZ-5,08 - 1776155



PCB connector, nominal current: 12 A, rated voltage (III/2): 320 V, Nominal cross section: 2.5 mm², number of positions: 4, pitch: 5.08 mm, connection method: Screw connection with tension sleeve, color: green, contact surface: Tin

Printed-circuit board connector - FRONT-MSTB 2,5/ 4-ST-5,08 - 1777303



PCB connector, nominal current: 12 A, rated voltage (III/2): 320 V, Nominal cross section: 2.5 mm², number of positions: 4, pitch: 5.08 mm, connection method: Front screw connection, color: green, contact surface: Tin

Printed-circuit board connector - MSTBT 2,5/ 4-ST-5,08 - 1780002



PCB connector, nominal current: 12 A, rated voltage (III/2): 320 V, Nominal cross section: 2.5 mm², number of positions: 4, pitch: 5.08 mm, connection method: Screw connection with tension sleeve, color: green, contact surface: Tin

Printed-circuit board connector - MVSTBR 2,5/ 4-ST-5,08 - 1792265



PCB connector, nominal current: 12 A, rated voltage (III/2): 320 V, Nominal cross section: 2.5 mm², number of positions: 4, pitch: 5.08 mm, connection method: Screw connection with tension sleeve, color: green, contact surface: Tin

Feed-through header - MSTB 2,5/ 4-G-5,08 - 1759033

Accessories

Printed-circuit board connector - MVSTBW 2,5/ 4-ST-5,08 - 1792773



PCB connector, nominal current: 12 A, rated voltage (III/2): 320 V, Nominal cross section: 2.5 mm², number of positions: 4, pitch: 5.08 mm, connection method: Screw connection with tension sleeve, color: green, contact surface: Tin

Printed-circuit board connector - MSTBC 2,5/ 4-ST-5,08 - 1808832



PCB connector, nominal current: 12 A, rated voltage (III/2): 320 V, Nominal cross section: 2.5 mm², number of positions: 4, pitch: 5.08 mm, connection method: Crimp connection, color: green, Corresponding female crimp contacts with current [A] and conductor cross section range [mm²] data: 10A/MSTBC-MT 0,5-1,0 (3190564); 10A/MSTBC-MT 0,5-1,0 BA (3190645); 12A/MSTBC-MT 1,5-2,5 (3190551); 12A/MSTBC-MT 1,5-2,5 BA (3190658). BA = Bandkontakte

Printed-circuit board connector - MSTBC 2,5/ 4-STZ-5,08 - 1809527



PCB connector, nominal current: 12 A, rated voltage (III/2): 320 V, Nominal cross section: 2.5 mm², number of positions: 4, pitch: 5.08 mm, connection method: Crimp connection, color: green, Corresponding female crimp contacts with current [A] and conductor cross section range [mm²] data: 10A/MSTBC-MT 0,5-1,0 (3190564); 10A/MSTBC-MT 0,5-1,0 BA (3190645); 12A/MSTBC-MT 1,5-2,5 (3190551); 12A/MSTBC-MT 1,5-2,5 BA (3190658). BA = Bandkontakte

Printed-circuit board connector - MSTBU 2,5/ 4-STD-5,08 - 1824146



Direct plug-in block, nominal current: 12 A, rated voltage (III/2): 320 V, Nominal cross section: 2.5 mm², number of positions: 4, pitch: 5.08 mm, connection method: Screw connection with tension sleeve, color: green, contact surface: Tin, mounting: Direct mounting

Printed-circuit board connector - MSTBU 2,5/ 4-ST-5,08-FL - 1824379



Direct plug-in block, nominal current: 12 A, rated voltage (III/2): 320 V, Nominal cross section: 2.5 mm², number of positions: 4, pitch: 5.08 mm, connection method: Screw connection with tension sleeve, color: green, contact surface: Tin, mounting: Direct mounting

Feed-through header - MSTB 2,5/ 4-G-5,08 - 1759033

Accessories

Printed-circuit board connector - SMSTB 2,5/ 4-ST-5,08 - 1826306

PCB connector, nominal current: 12 A, rated voltage (III/2): 320 V, Nominal cross section: 2.5 mm², number of positions: 4, pitch: 5.08 mm, connection method: Screw connection with tension sleeve, color: green, contact surface: Tin



Printed-circuit board connector - TMSTBP 2,5/ 4-ST-5,08 - 1853036

PCB connector, nominal current: 12 A, rated voltage (III/2): 320 V, Nominal cross section: 2.5 mm², number of positions: 4, pitch: 5.08 mm, connection method: Screw connection with tension sleeve, color: green, contact surface: Tin, The plug allows conductors to be looped through from module to module.



Printed-circuit board connector - FKC 2,5/ 4-ST-5,08 - 1873074

PCB connector, nominal current: 12 A, rated voltage (III/2): 320 V, Nominal cross section: 2.5 mm², number of positions: 4, pitch: 5.08 mm, connection method: Push-in spring connection, color: green, contact surface: Tin



Printed-circuit board connector - FKCVW 2,5/ 4-ST-5,08 - 1873676

PCB connector, nominal current: 12 A, rated voltage (III/2): 320 V, Nominal cross section: 2.5 mm², number of positions: 4, pitch: 5.08 mm, connection method: Push-in spring connection, color: green, contact surface: Tin



Printed-circuit board connector - FKCVR 2,5/ 4-ST-5,08 - 1873977

PCB connector, nominal current: 12 A, rated voltage (III/2): 320 V, Nominal cross section: 2.5 mm², number of positions: 4, pitch: 5.08 mm, connection method: Push-in spring connection, color: green, contact surface: Tin



Feed-through header - MSTB 2,5/ 4-G-5,08 - 1759033

Accessories

Printed-circuit board connector - QC 1/ 4-ST-5,08 - 1883271



PCB connector, nominal current: 10 A, rated voltage (III/2): 630 V, Nominal cross section: 1 mm², number of positions: 4, pitch: 5.08 mm, connection method: Displacement connection, color: green, contact surface: Tin

Printed-circuit board connector - FKCT 2,5/ 4-ST-5,08 - 1902136



PCB connector, nominal current: 12 A, rated voltage (III/2): 320 V, Nominal cross section: 2.5 mm², number of positions: 4, pitch: 5.08 mm, connection method: Push-in spring connection, color: green, contact surface: Tin

Printed-circuit board connector - TFKC 2,5/ 4-ST-5,08 - 1962626



PCB connector, nominal current: 12 A, rated voltage (III/2): 320 V, Nominal cross section: 2.5 mm², number of positions: 4, pitch: 5.08 mm, connection method: Push-in spring connection, color: green, contact surface: Tin

Printed-circuit board connector - FKCS 2,5/ 4-ST-5,08 - 1975095



PCB connector, nominal current: 12 A, rated voltage (III/2): 320 V, Nominal cross section: 2.5 mm², number of positions: 4, pitch: 5.08 mm, connection method: Push-in spring connection, color: green, contact surface: Tin