

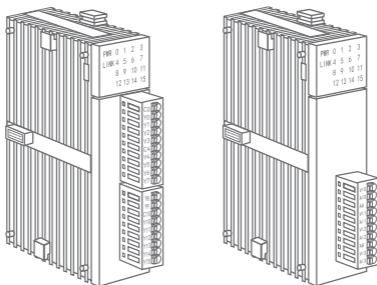

EKF



TECHNICAL MANUAL

Digital and analog modules
PRO-Logic EKF

1 DESCRIPTION

The digital/analog modules for the programmable controller PRO-Logic are designed to expand the number of inputs/outputs and connect digital and analog signals to the head module (controller). The digital/analog modules for the programmable controller PRO-Logic comply with IEC 61131-2:2017.

2 TECHNICAL DATA

Table 1 - Power supply characteristics

Characteristics	Value
Voltage	24 V DC (20,4...28,8 V)
Power consumption	<4,8 W
Max. operating time with power failure	10 ms

Table 2 - Operation conditions

Characteristics	Value
Operating temperature	0...55 °C
Storage temperature	-20...+70 °C
Humidity	5...95% RH (no condensate)
Noise immunity	±2500 V AC, ±1000 V DC
Degree of protection	IP20

Table 3 - DI

Characteristics	Value
Signal type	Digital, PNP / NPN
Resistance	4,3 kOhm
Max. current	10 mA
Filter	6,4 ms (default), ranges from 0,8 to 51,2 ms
Insulation type	Optic coupler for every channel
Indication	LED (for every signal)
Power	24 V DC

Table 4 - DO

Characteristics		Value	
Signal type		Electromagnetic relay	NPN-transistor
Load	Resistive	2 A	0,5 A
	Inductive	50 VA	5 W (24 V)
	Lighting	100 W	12 W (24 V)
Voltage		≤ 250 V AC ≤ 30 V DC	≤ 30 V DC
Max. load		5 A (250 V AC)	1 A (for 10 s)
Response time		ON 10 ms OFF 5 ms	ON 10 μs OFF 120 μs
Insulation		Electro-mechanical	Optic coupler for every channel
Indication		LED (for every signal)	

Table 5 - High-speed inputs/outputs (HSI/HSO)

Characteristics	Value
Max. frequency	200 kHz

Table 6 - AI

Characteristics	Value			
Signal type	0...10 V	0...5 V	1...5 V	0...20 mA and 4...20 mA
Resolution	2,5 mV	1,25 mV	1,25 mV	5 μ A
Resistance	6 MOhm			250 Ohm
Max. signal value	\pm 13 V			\pm 30 mA
Indication	LED (for every signal)			
Response time	5 ms / 4 channels			
Signal form	12 bit (0...32000)			
Relative error	0,2%			
Insulation	Optic coupler for every channel			

Table 7 - AO

Characteristics	Value			
Signal type	0...10 V	0...5 V	1...5 V	0...20 mA and 4...20 mA
Resolution	2,5 mV	1,25 mV	1,25 mV	5 μ A
Resistance	1 kOhm (10 V)	\geq 500 Ohm (10 V)		\leq 500 Ohm
Max. signal value	\pm 13 V			\pm 30 mA
Indication	LED (for every signal)			
Response time	3 ms			
Signal form	12 bit (0...32000)			
Relative error	0,2%			
Insulation	Optic coupler for every channel			

3 DIGITAL AND ANALOG MODULE VERSIONS

Table 8

Item code	Name
EMF-D-8X	Digital input module EMF 8 PRO-Logic EKF
EMF-D-8Y-R	Digital output module EMF 8 PRO-Logic EKF
EMF-D-8Y-N	Digital output module EMF 8 N PRO-Logic EKF
EMF-D-4X4Y-R	Digital I/O module EMF 4/4 PRO-Logic EKF
EMF-D-4X4Y-N	Digital I/O module EMF 4/4 N PRO-Logic EKF
EMF-D-16X	Digital input module EMF 16 PRO-Logic EKF
EMF-D-16Y-R	Digital output module EMF 16 PRO-Logic EKF
EMF-D-16Y-N	Digital output module EMF 16 N PRO-Logic EKF
EMF-D-8X8Y-R	Digital I/O module EMF 8/8 PRO-Logic EKF
EMF-D-8X8Y-N	Digital I/O module EMF 8/8 N PRO-Logic EKF
EMF-A-4AI	Analog input module EMF 4 PRO-Logic EKF
EMF-A-4AO	Analog output module EMF 4 PRO-Logic EKF
EMF-A-2AI2AO	Analog I/O module EMF 2/2 PRO-Logic EKF
EMF-A-8AI	Analog input module EMF 8 PRO-Logic EKF
EMF-A-8AO	Analog output module EMF 8 PRO-Logic EKF
EMF-A-4AI4AO	Analog I/O module EMF 4/4 PRO-Logic EKF

4 DETAILS OF DIGITAL AND ANALOG MODULE VERSIONS

Table 9

Item code	DI	DO	AI	AO
EMF-D-8X	8			
EMF-D-8Y-R		8 EM relays		
EMF-D-8Y-N		8 NPN		
EMF-D-4X4Y-R	4	4 EM relays		
EMF-D-4X4Y-N	4	4 NPN		
EMF-D-16X	16			
EMF-D-16Y-R		16 EM relays		
EMF-D-16Y-N		16 NPN		
EMF-D-8X8Y-R	8	8 EM relays		
EMF-D-8X8Y-N	8	8 NPN		
EMF-A-4AI			4	
EMF-A-4AO				4
EMF-A-2AI2AO			2	2
EMF-A-8AI			8	
EMF-A-8AO				8
EMF-A-4AI4AO			4	4

5 OVERALL DIMENSIONS

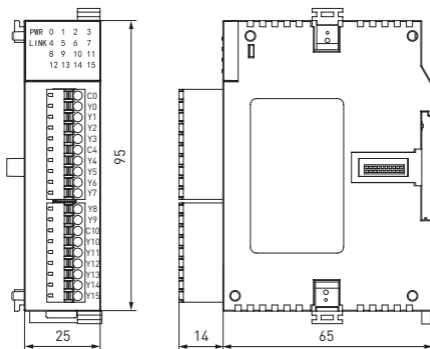

Fig. 1 - Overall dimensions of digital I/O module

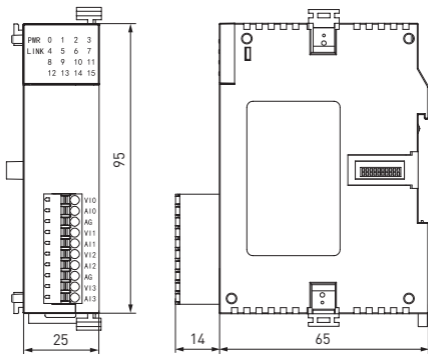

Fig. 2 - Overall dimensions of analog I/O module

6 MAIN ELEMENTS

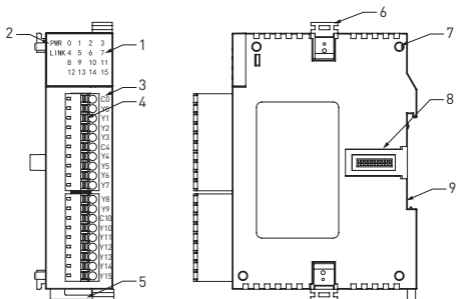
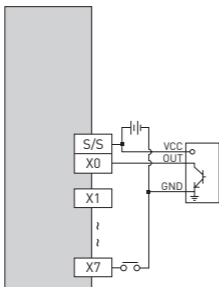

Fig. 3 - Main elements of digital I/O module

- 1 - Indication panel
- 2 - Operating mode LED
- 3 - Inputs/Outputs
- 4 - Removable terminal blocks
- 5 - DIN rail mounting clamp
- 6 - Expansion module lock
- 7 - Holes for expansion module/controller connection
- 8 - Port for expansion module connection
- 9 - DIN rail mounting seat

7 DIGITAL I/O CONNECTION



Inputs: NPN-transistors

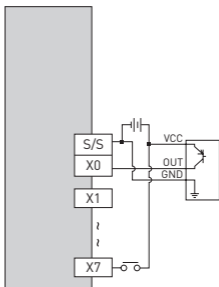

Inputs: PNP-transistors

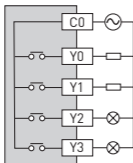

Outputs:
electromagnetic
relays

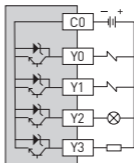

Outputs:
NPN-transistors

Fig. 4 - Digital I/O connection

8 ANALOG INPUT CONNECTION

Two-wire circuit

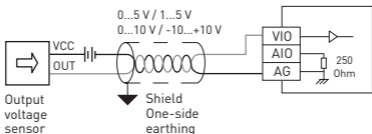

Three-wire circuit

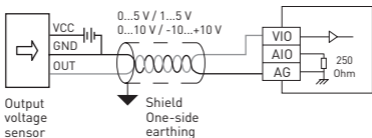

Four-wire circuit

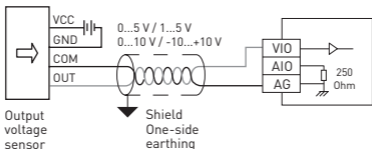
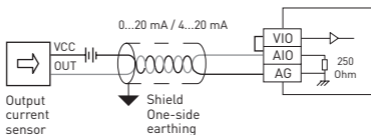
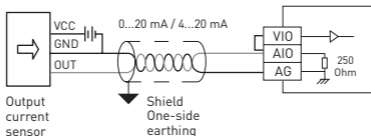

Fig. 5 - Analog input connection (input signal - voltage)

Two-wire circuit



Three-wire circuit



Four-wire circuit

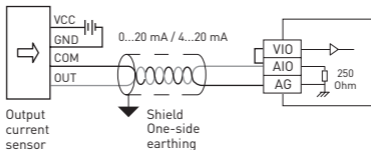

Fig. 6 - Analog input connection
(input signal - current)

9 ANALOG OUTPUT CONNECTION

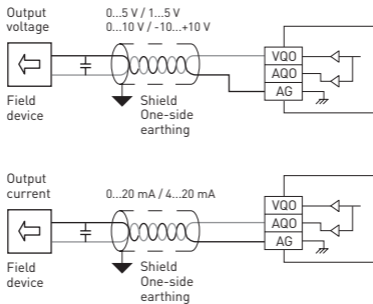

Fig. 7 - Analog output connection

10 I/O SPECIFICATION

Digital expansion modules

EMF-D-8X

S/S	S/S	X0	X1	X2	X3	X4	X5	X6	X7
-----	-----	----	----	----	----	----	----	----	----

EMF-D-8Y-x

C0	Y0	Y1	Y2	Y3	C4	Y4	Y5	Y6	Y7
----	----	----	----	----	----	----	----	----	----

EMF-D-4X4Y-x

C0	Y0	Y1	Y2	Y3	S/S	X0	X1	X2	X3
----	----	----	----	----	-----	----	----	----	----

EMF-D-16X

S/S	X0	X1	X2	X3	X4	X5	X6	X7	X8	S/S	X9	X10	X11	X12	X13	X14	X15	•
-----	----	----	----	----	----	----	----	----	----	-----	----	-----	-----	-----	-----	-----	-----	---

EMF-D-16Y-x

C0	Y0	Y1	Y2	Y3	C4	Y4	Y5	Y6	Y7	Y8	Y9	C10	Y10	Y11	Y12	Y13	Y14	Y15
----	----	----	----	----	----	----	----	----	----	----	----	-----	-----	-----	-----	-----	-----	-----

EMF-D-8X8Y-x

C0	Y0	Y1	Y2	Y3	C4	Y4	Y5	Y6	Y7	S/S	X0	X1	X2	X3	X4	X5	X6	X7
----	----	----	----	----	----	----	----	----	----	-----	----	----	----	----	----	----	----	----

Analog expansion modules

EMF-A-4AO

VQ0	AQ0	AG	VQ1	AQ1	VQ2	AQ2	AG	VQ3	AQ3
-----	-----	----	-----	-----	-----	-----	----	-----	-----

EMF-A-4AI

VI0	AI0	AG	VI1	AI1	VI2	AI2	AG	VI3	AI3
-----	-----	----	-----	-----	-----	-----	----	-----	-----

EMF-A-2AI2AO

VI0	AI0	AG	VI1	AI1	VQ0	AQ0	AG	VQ1	AQ1
-----	-----	----	-----	-----	-----	-----	----	-----	-----

EMF-A-8AI

VI0	AI0	AG	VI1	AI1	VI2	AI2	AG	VI3	AI3	VI4	AI4	VI5	AI5	AG	VI6	AI6	VI7	AI7
-----	-----	----	-----	-----	-----	-----	----	-----	-----	-----	-----	-----	-----	----	-----	-----	-----	-----

EMF-A-8AO

VQ0	AQ0	AG	VQ1	AQ1	VQ2	AQ2	AG	VQ3	AQ3	VQ4	AQ4	VQ5	AQ5	AG	VQ6	AQ6	VQ7	AQ7
-----	-----	----	-----	-----	-----	-----	----	-----	-----	-----	-----	-----	-----	----	-----	-----	-----	-----

EMF-A-4AI4AO

VI0	AI0	AG	VI1	AI1	VI2	AI2	AG	VI3	AI3	VQ0	AQ0	VQ1	AQ1	AG	VQ2	AQ2	VQ3	AQ3
-----	-----	----	-----	-----	-----	-----	----	-----	-----	-----	-----	-----	-----	----	-----	-----	-----	-----

11 INDICATION

PWR: power, green. Steady ON - power ON. OFF - power OFF.

LINK: multi-status indicator (red/yellow/green). For details, refer to the table below.

Table 10

Troubleshooting	Value	LINK LED status
Normal operation. No actions required	No link with module	OFF
	Controller has detected module, but is not communicating with it	Steady green
	Controller is communicating with module	Flashing green
Connect a higher power supply	Higher power supply is required	Flashing yellow
Correct the program and reload it to the controller	Module firmware error	Flashing red
Contact the manufacturer	Device error	Steady red

12 INSTALLATION AND CONNECTION

Install the programmable controller and digital/analog modules in the enclosed cabinet. Leave 50 mm gaps between the device and all sides of the cabinet for heat dissipation.

Mount the digital/analog modules to a standard 35 mm DIN rail. Connect the programmable controller to the expansion modules concurrently via the built-in port (to the controller's right).

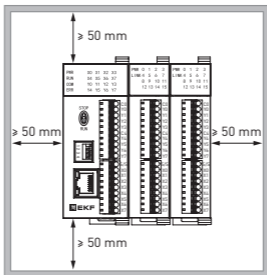

Power supply, input and output signals shall be connected with clamp terminals, max. wire cross-section of 1 mm².



WARNING! Follow the sequence for connecting the digital/analog modules to the controller!
The interface modules shall be installed first in line.

13 DELIVERY SCOPE

Digital/analog module - 1 pc.

Terminal block - 1 or 2 pcs. (depends on version)

Technical manual - 1 pc.

14 SAFETY REQUIREMENTS

Do not operate digital/analog modules with visual mechanical damage. Expansion modules shall be operated and serviced only by qualified personnel.

Failure to follow the guidelines herein may result in severe injuries and equipment damage.

15 TRANSPORTATION AND STORAGE

The digital/analog modules can be transported by any means of enclosed transport that ensures protection of packed products from mechanical and atmospheric impacts.

The digital/analog modules shall be stored in the original package indoors at the ambient temperature from -20° C to +70° C and relative humidity of max. 98% at +25°C.

17 DISPOSAL

Life-expired and failed products shall be disposed of in compliance with the laws and regulations in force in the territory of product sale. To dispose of the product, send it to an authorized company for recycling in compliance with the national and local laws and regulations in force.

16 MANUFACTURER'S WARRANTY

The manufacturer guarantees the products comply with the declared characteristics, provided that the consumer follows the operation, transportation and storage conditions.

Warranty period: 3 years from the date of sale.

Shelf life: 3 years from the date of manufacture.

Service life: 10 years.

Manufacturer: for information, refer to the product package.

Importer and EKF trademark service representative:

EKF ELECTRICAL SOLUTION – FZCO, Dubai Silicon Oasis, DDP, Building A2, Dubai, United Arab Emirates.

Importer and EKF trademark service representative on the territory of the Russian Federation: OOO «Electroresheniya», Otradnaya st., 2b bld. 9, 5th floor, 127273, Moscow, Russia. Tel.: +7 (495) 788-88-15.

Importer and EKF trademark service representative on the territory of the Republic of Kazakhstan: TOO «Energosheniya Kazakhstan», Kazakhstan, Almaty, Bostandyk district, Turgut Ozal st., 247, apt 4.

15 CERTIFICATE OF ACCEPTANCE

The digital/analog module has been manufactured in compliance with laws and regulations in force and has been approved for operation.

Date of manufacture:

For information, refer to the product package.

Quality control stamp



ekfgroup.com

v2