

## Accessories - IC-DFR 2 - 1852024

Please be informed that the data shown in this PDF Document is generated from our Online Catalog. Please find the complete data in the user's documentation. Our General Terms of Use for Downloads are valid (<http://phoenixcontact.com/download>)



Panel mounting frame, nominal cross section: 2.5 mm<sup>2</sup>, number of positions: 2, pitch: 5.08 mm, color: green, This assembly frame can only be used in combination with IC 2,5/...-STGF-5,08

### Your advantages

- Feed-through assembly frame for inverted COMBICON connector IC 2,5/-STGF-5,08
- Cable connection on the inside of the device enables flexible positioning of the panel feed-through
- Mounting flanges reduce the mechanical strain on the soldering spots
- Can be combined with the MSTB 2,5 range



### Key Commercial Data

Packing unit	50 pc
GTIN	
GTIN	4017918108908

### Technical data

#### Dimensions

Length	19 mm
Height	16.75 mm
Width	33.83 mm
Pitch	5.08 mm
Dimension a	11.98 mm

#### General

Range of articles	IC-DFR
Insulating material group	I
Nominal cross section	2.5 mm <sup>2</sup>
Insulating material	PA
Flammability rating according to UL 94	V0
Number of positions	2

# Accessories - IC-DFR 2 - 1852024

## Technical data

### Standards and Regulations

Flammability rating according to UL 94	V0
--	----

### Environmental Product Compliance

China RoHS	Environmentally friendly use period: unlimited = EFUP-e
	No hazardous substances above threshold values

## Drawings

Drilling diagram

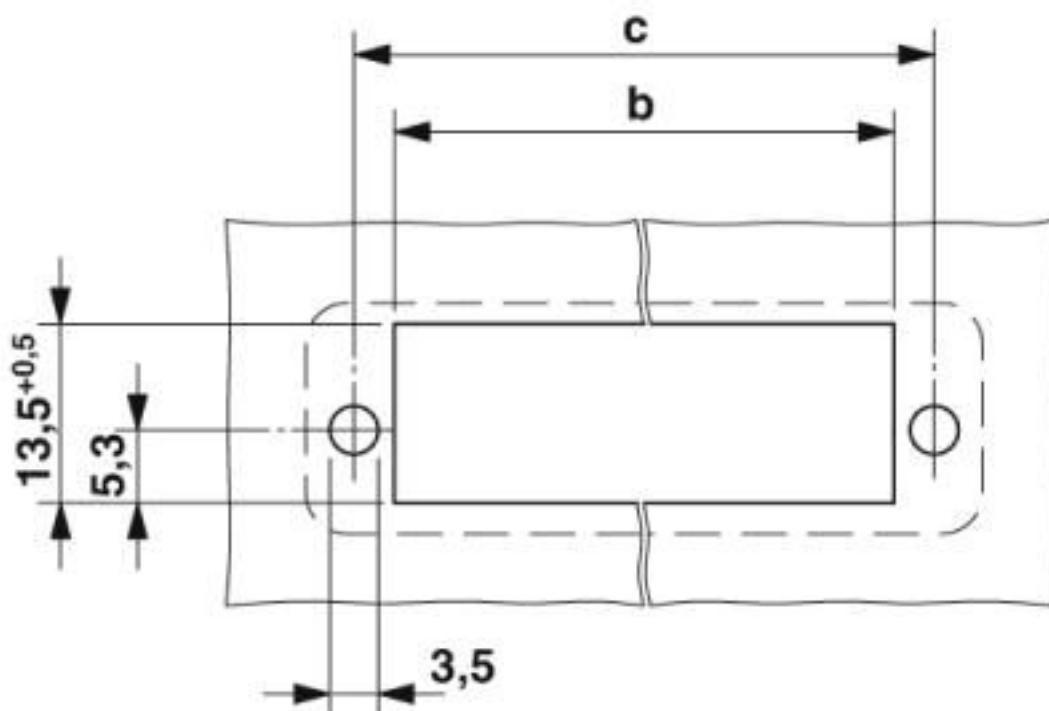

Dimension b: 10.84 mm + (no. of pos. x 5.08 mm)

Dimension c: Dim. b + 5.83 mm

## Classifications

eCl@ss

eCl@ss 10.0.1	27440390
eCl@ss 4.0	27260700
eCl@ss 4.1	27260700
eCl@ss 5.0	27260700
eCl@ss 5.1	27260700
eCl@ss 6.0	27261200
eCl@ss 7.0	27440210

# Accessories - IC-DFR 2 - 1852024

## Classifications

### eCl@ss

eCl@ss 8.0	27440390
eCl@ss 9.0	27440392

### ETIM

ETIM 3.0	EC000879
ETIM 4.0	EC000879
ETIM 5.0	EC002310
ETIM 6.0	EC002310
ETIM 7.0	EC002310

### UNSPSC

UNSPSC 6.01	30211810
UNSPSC 7.0901	39121409
UNSPSC 11	39121409
UNSPSC 12.01	39121409
UNSPSC 13.2	39121421
UNSPSC 18.0	39121421
UNSPSC 19.0	39121421
UNSPSC 20.0	39121421
UNSPSC 21.0	39121421

## Approvals

### Approvals

---

### Approvals

EAC

---

### Ex Approvals

---

### Approval details

EAC		B.01687
-----	--	---------

## Accessories

Accessories

Mounting material

## Accessories - IC-DFR 2 - 1852024

### Accessories

Screw set - DFK-MSTB-SS - 0708263



Screw set, for securing the header to the device wall, consists of an M3 x 10 screw, with a spring washer and a nut

---

### PCB plug

Printed-circuit board connector - IC 2,5/ 2-STGF-5,08 - 1825501



PCB connector, nominal current: 12 A, rated voltage (III/2): 320 V, nominal cross section: 2.5 mm<sup>2</sup>, number of positions: 2, pitch: 5.08 mm, connection method: Screw connection with tension sleeve, color: green, contact surface: Tin

---

Phoenix Contact 2020 © - all rights reserved  
<http://www.phoenixcontact.com>

PHOENIX CONTACT GmbH & Co. KG  
Flachsmarktstr. 8  
32825 Blomberg  
Germany  
Tel. +49 5235 300  
Fax +49 5235 3 41200  
<http://www.phoenixcontact.com>

# Mouser Electronics

Authorized Distributor

Click to View Pricing, Inventory, Delivery & Lifecycle Information:

[Phoenix Contact:](#)

[1852024](#)