

APPROVED BY: DATE: MFG. ENG. QA

NOTES:

1. ALL PARTS ARE BULK PACKED.
2. REFER TO DRAWING HPMCSTD FOR CONTACT PATTERNS.
3. ALL DIMENSIONS ARE REFERENCE ONLY IN INCHES [mm], WITHIN ±0.015 UNLESS OTHERWISE NOTED.

ASS'Y P/N	CONTACT QTY.	CABLE O.D. RANGE
W18982-5SG-P-518	5	0.18 - 0.20 [4.6 - 5.1]
W18982-5SG-P-521	5	0.21 - 0.22 [5.3 - 5.6]
W18982-5SG-P-522	5	0.22 - 0.23 [5.6 - 5.8]
W18982-6SG-P-518	6	0.18 - 0.20 [4.6 - 5.1]
W18982-6SG-P-521	6	0.21 - 0.22 [5.3 - 5.6]
W18982-6SG-P-522	6	0.22 - 0.23 [5.6 - 5.8]
W18982-7SG-P-518	7	0.18 - 0.20 [4.6 - 5.1]
W18982-7SG-P-521	7	0.21 - 0.22 [5.3 - 5.6]
W18982-7SG-P-522	7	0.22 - 0.23 [5.6 - 5.8]
W18982-XSG-P-5XX		

CUSTOMER PRINT

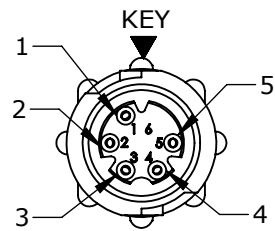

FACE VIEW
W18982-5SG-P-5XX
5 POSITION

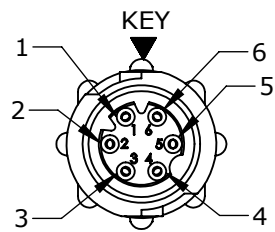

FACE VIEW
W18982-6SG-P-5XX
6 POSITION

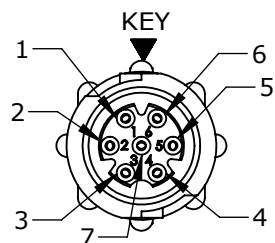

FACE VIEW
W18982-7SG-P-5XX
7 POSITION

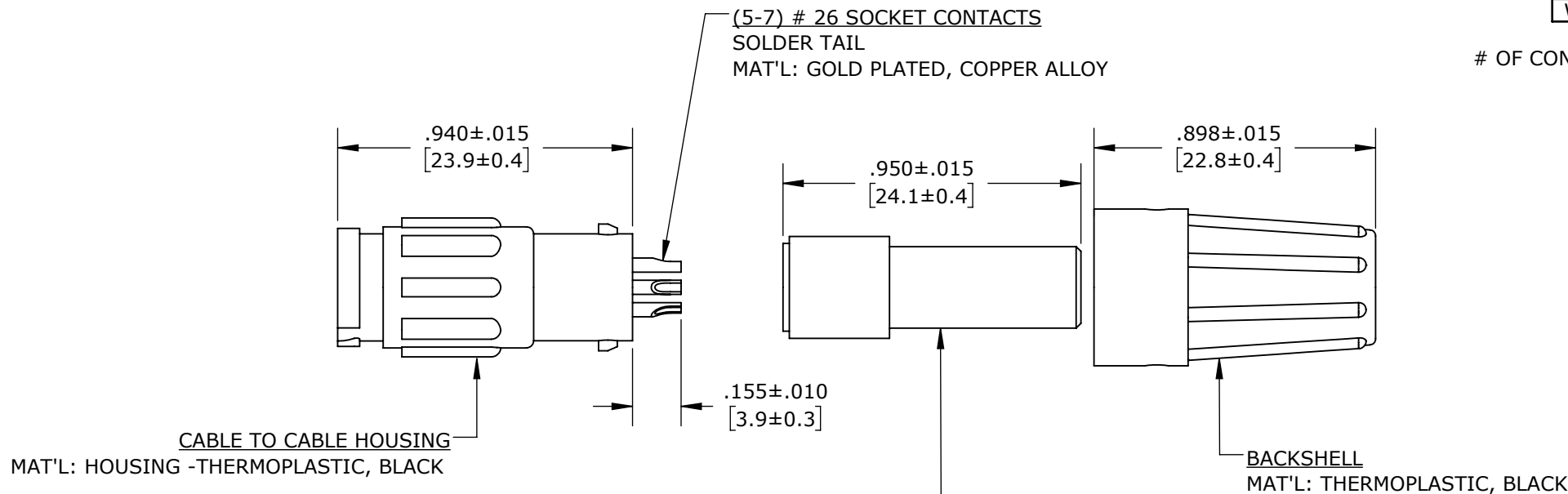

OF CONTACTS

GROMMET SIZE = CABLE O.D. RANGE:
518 = 0.18 - 0.20 [4.6 - 5.1]
521 = 0.21 - 0.22 [5.3 - 5.6]
522 = 0.22 - 0.23 [5.6 - 5.8]

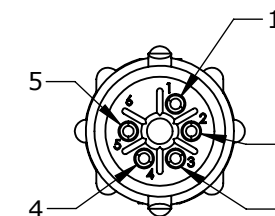

WIRING VIEW
W18982-5SG-P-5XX

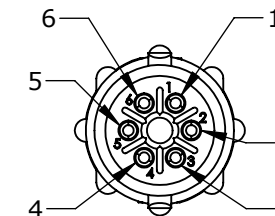

WIRING VIEW
W18982-6SG-P-5XX

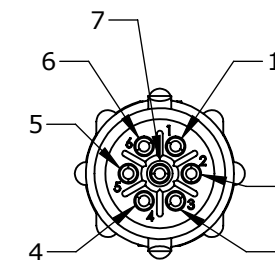

WIRING VIEW
W18982-7SG-P-5XX

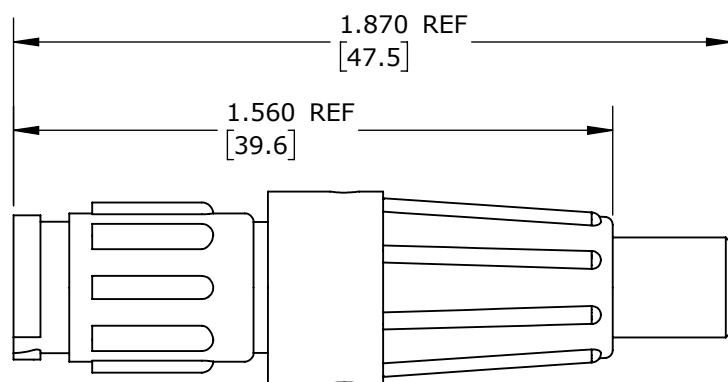

ASSEMBLED VIEW
FOR CUSTOMER REF. ONLY

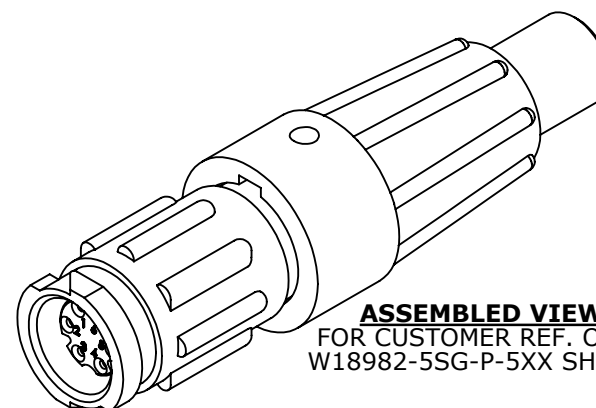

ASSEMBLED VIEW
FOR CUSTOMER REF. ONLY
W18982-5SG-P-5XX SHOWN

CUSTOMER APPROVAL

THIS DOCUMENT CONTAINS CONFIDENTIAL INFORMATION PROPRIETARY TO CONXALL CORPORATION. ANY REPRODUCTION, DISCLOSURE, OR USE OF THIS DOCUMENT /INFORMATION IS EXPRESSLY PROHIBITED UNLESS AUTHORIZED IN WRITING BY CONXALL CORPORATION.

APPROVED BY: _____

DATE: _____

RoHS COMPLIANT

DIMENSIONS IS BRACKETS [] ARE METRIC

PRELIMINARY

PART NUMBER: W18982-XSG-P-5XX

0A	JGK	8/29/19	DRAWING CREATED FOR PDR #18004.	
REV.	INIT.	DATE	DESCRIPTION	
			ORIG. DRAWN BY: JGK	DATE: 8/29/19
ALL INFORMATION ILLUSTRATED IS THE PROPERTY OF "CONXALL CORPORATION". UNAUTHORIZED DUPLICATION OR DISTRIBUTION OF THIS DOCUMENT IS PROHIBITED.			<p>601 E. WILDWOOD VILLA PARK, IL 60181</p>	
ALL UNITS ARE IN FEET, INCHES, FRACTION OF INCHES AND DECIMALS.			TITLE: CABLE TO CABLE CONN. ASS'Y (5-7) #26 SOCKET CONTACTS, SOLDER INSTA-CLICK, MICRO-CON-X STANDARD PRODUCT	
UNLESS OTHERWISE SPECIFIED TOLERANCES: 3 PLACE DECIMALS ±.005 ANGLES ±1° FRACTIONS ±1/16			APPROVED BY:	CUSTOMER:
SCALE	SIZE	SHEET		
NTS	B	1 OF 1		
FILE:	DIRECTORY:	PART NUMBER:	REV	
W18982-XSG-P-5XX	SLW	W18982-XSG-P-5XX	0A	