

$I_{F(AV)} = 3.0\text{Amp}$   
 $V_R = 40\text{V}$

**Major Ratings and Characteristics**

Characteristics	Value	Units
$I_{F(AV)}$ Rectangular waveform	3.0	A
$V_{RRM}$	40	V
$I_{FSM}$ @ $t_p = 5\mu\text{s}$ sine	1580	A
$V_F$ @ $3.0\text{Apk}, T_J = 125^\circ\text{C}$	0.43	V
$T_J$ range	- 55 to 150	$^\circ\text{C}$



**Description/ Features**

The MBRS340TR surface-mount Schottky rectifier has been designed for applications requiring low forward drop and small foot prints on PC boards. Typical applications are in disk drives, switching power supplies, converters, free-wheeling diodes, battery charging, and reverse battery protection.

- Small foot print, surface mountable
- Very low forward voltage drop
- High frequency operation
- Guard ring for enhanced ruggedness and long term reliability

**Case Styles**

MBRS340TR

SMC

## Voltage Ratings

Part number	MBRS340TR
$V_R$ Max. DC Reverse Voltage (V)	40
$V_{RWM}$ Max. Working Peak Reverse Voltage (V)	

## Absolute Maximum Ratings

Parameters	Value	Units	Conditions
$I_{F(AV)}$ Max. Average Forward Current	3.0	A	50% duty cycle @ $T_L = 118^\circ\text{C}$ , rectangular wave form
	4.0		50% duty cycle @ $T_L = 110^\circ\text{C}$ , rectangular wave form
$I_{FSM}$ Max. Peak One Cycle Non-Repetitive Surge Current	1580	A	5 $\mu\text{s}$ Sine or 3 $\mu\text{s}$ Rect. pulse
	80		10ms Sine or 6ms Rect. pulse
$E_{AS}$ Non Repetitive Avalanche Energy	6	mJ	$T_J = 25^\circ\text{C}$ , $I_{AS} = 1.0\text{A}$ , $L = 12\text{mH}$
$I_{AR}$ Repetitive Avalanche Current	1.0	A	Current decaying linearly to zero in 1 $\mu\text{sec}$ Frequency limited by $T_J$ max. $V_a = 1.5 \times V_r$ typical

## Electrical Specifications

Parameters	Value	Units	Conditions
$V_{FM}$ Max. Forward Voltage Drop (1)	0.525	V	@ 3A
	0.68	V	@ 6A
	0.43	V	@ 3A
	0.57	V	@ 6A
$I_{RM}$ Max. Reverse Leakage Current	2.0	mA	$T_J = 25^\circ\text{C}$
	20	mA	$T_J = 100^\circ\text{C}$
	35	mA	$T_J = 125^\circ\text{C}$
$C_T$ Max. Junction Capacitance	230	pF	$V_R = 5V_{DC}$ (test signal range 100KHz to 1Mhz) $25^\circ\text{C}$
$L_S$ Typical Series Inductance	3.0	nH	Measured lead to lead 5mm from package body
dv/dt Max. Voltage Rate of Change	10000	V/ $\mu\text{s}$	(Rated $V_R$ )

(1) Pulse Width < 300 $\mu\text{s}$ , Duty Cycle < 2%

## Thermal-Mechanical Specifications

Parameters	Value	Units	Conditions
$T_J$ Max. Junction Temperature Range (*)	-55 to 150	$^\circ\text{C}$	
$T_{stg}$ Max. Storage Temperature Range	-55 to 150	$^\circ\text{C}$	
$R_{thJL}$ Max. Thermal Resistance Junction to Lead (**)	12	$^\circ\text{C/W}$	DC operation
$R_{thJA}$ Max. Thermal Resistance Junction to Ambient	46	$^\circ\text{C/W}$	DC operation
wt Approximate Weight	0.24(0.008)	g(oz.)	
Case Style	SMC		Similar to DO-214AB
Device Marking	IR34		

(\*)  $\frac{dP_{tot}}{dT_J} < \frac{1}{R_{th(j-a)}}$  thermal runaway condition for a diode on its own heatsink

(\*\*) Mounted 1 inch square PCB

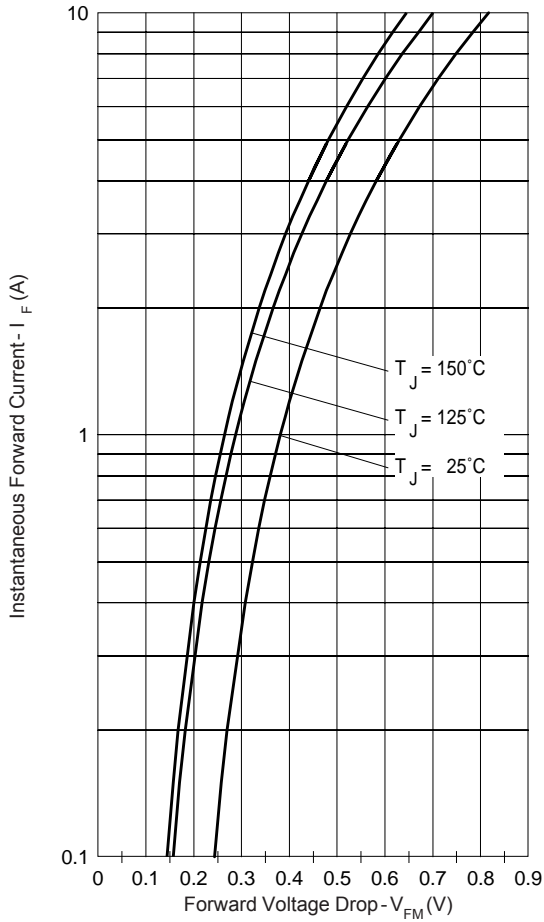

Fig. 1 - Max. Forward Voltage Drop Characteristics (Per Leg)

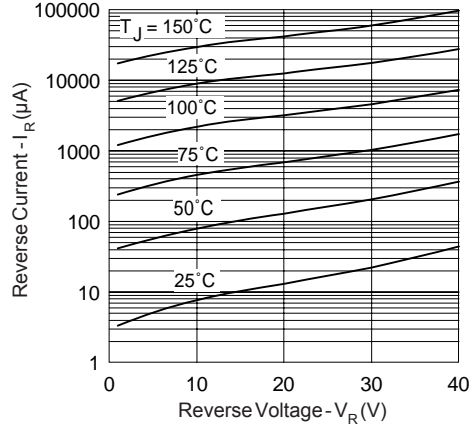

Fig. 2 - Typical Values Of Reverse Current Vs. Reverse Voltage (Per Leg)

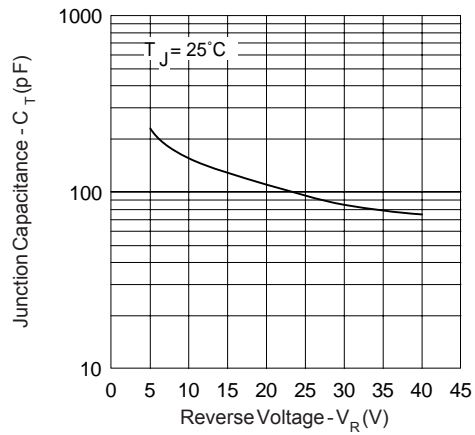

Fig. 3 - Typical Junction Capacitance Vs. Reverse Voltage (Per Leg)

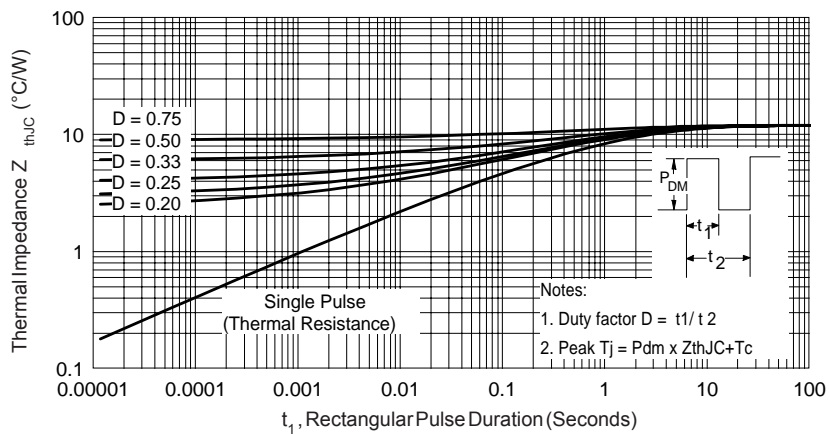

Fig. 4 - Max. Thermal Impedance  $Z_{thJC}$  Characteristics (Per Leg)

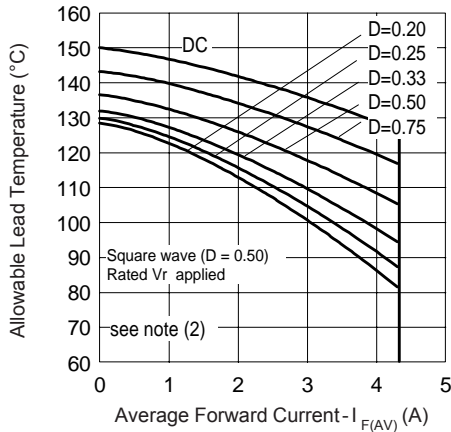

Fig. 4 - Maximum Average Forward Current Vs. Allowable Lead Temperature

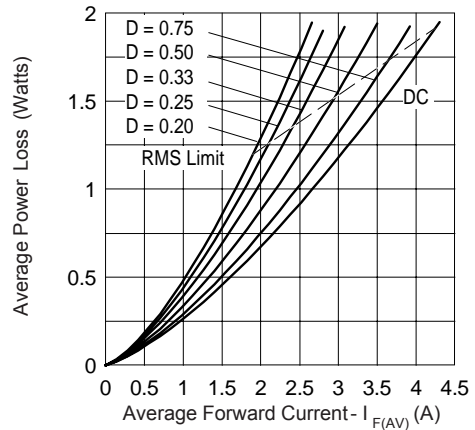

Fig. 5 - Maximum Average Forward Dissipation Vs. Average Forward Current

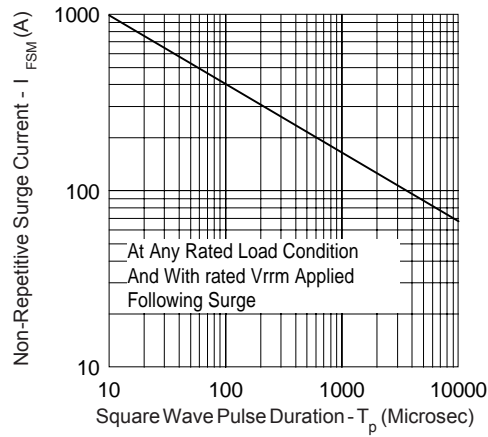
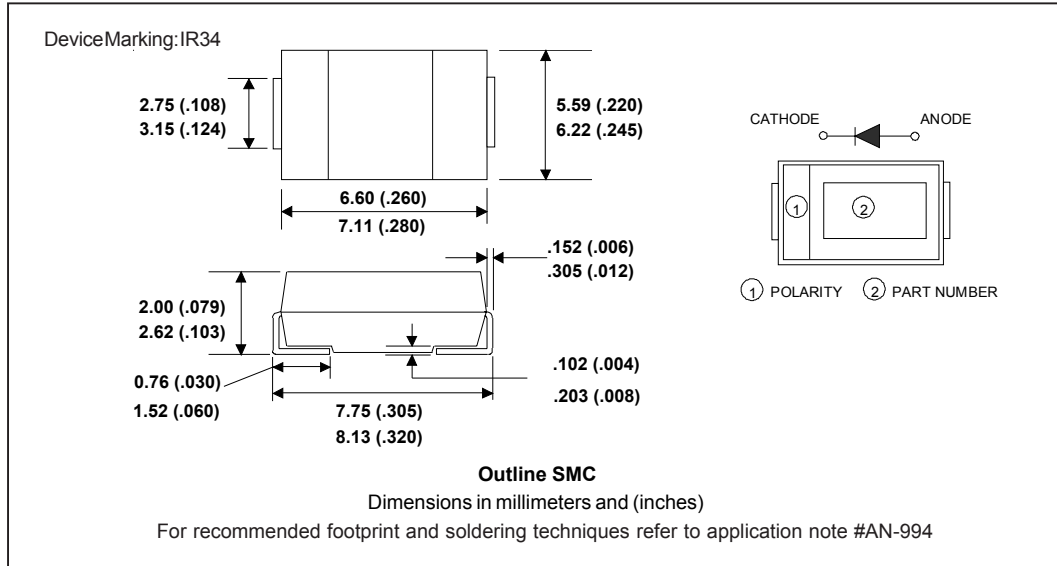

Fig. 6 - Maximum Peak Surge Forward Current Vs. Pulse Duration

- (2) Formula used:  $T_C = T_J - (Pd + Pd_{REV}) \times R_{thJC}$ ;  
 $Pd$  = Forward Power Loss =  $I_{F(AV)} \times V_{FM} @ (I_{F(AV)} / D)$  (see Fig. 6);  
 $Pd_{REV}$  = Inverse Power Loss =  $V_{R1} \times I_R (1 - D)$ ;  $I_R @ V_{R1} = 80\%$  rated  $V_R$

Outline Table



Marking & Identification

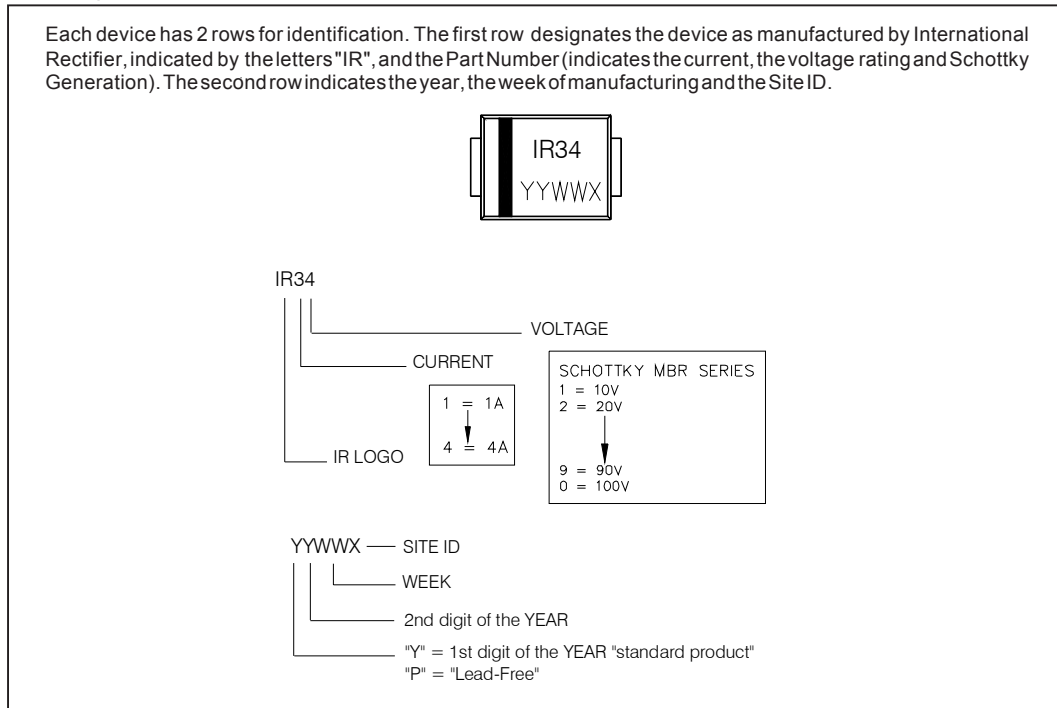

Tape & Reel Information

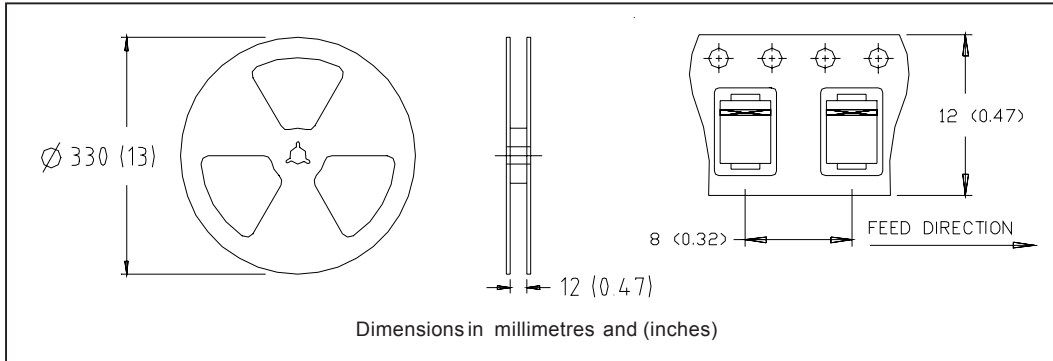

Ordering Information Table

Device Code	
<b>MBR</b>	<b>S</b>
<b>3</b>	<b>40</b>
<b>TR</b>	<b>-</b>
①	②
③	④
⑤	⑥

<p><b>1</b> - Schottky MBR Series</p> <p><b>2</b> - S = SMC</p> <p><b>3</b> - Current Rating (3 = 3 A)</p> <p><b>4</b> - Voltage Rating (40 = 40V)</p> <p><b>5</b> - TR = Tape &amp; Reel (3000 pieces)</p> <p><b>6</b></p>	<ul style="list-style-type: none"> <li>• none = Standard Production</li> <li>• PbF = Lead-Free</li> </ul>
---	---

Data and specifications subject to change without notice.  
This product has been designed and qualified for Industrial Level.  
Qualification Standards can be found on IR's Web site.