

Major Ratings and Characteristics

Characteristics	90SQ...	Units
$I_{F(AV)}$ Rectangular waveform	9	A
V_{RRM} range	30 to 45	V
I_{FSM} @tp = 5 μ s sine	2150	A
V_F @9 Apk, $T_J = 125^\circ\text{C}$	0.42	V
T_J range	-55 to 150	$^\circ\text{C}$

Description/Features

The 90SQ axial leaded Schottky rectifier series has been optimized for very low forward voltage drop, with moderate leakage. The proprietary barrier technology allows for reliable operation up to 150°C junction temperature. Typical applications are in switching power supplies, converters, free-wheeling diodes, and reverse battery protection.

- 150° C T_J operation
- High purity, high temperature epoxy encapsulation for enhanced mechanical strength and moisture resistance
- Very low forward voltage drop
- High frequency operation
- Guard ring for enhanced ruggedness and long term reliability

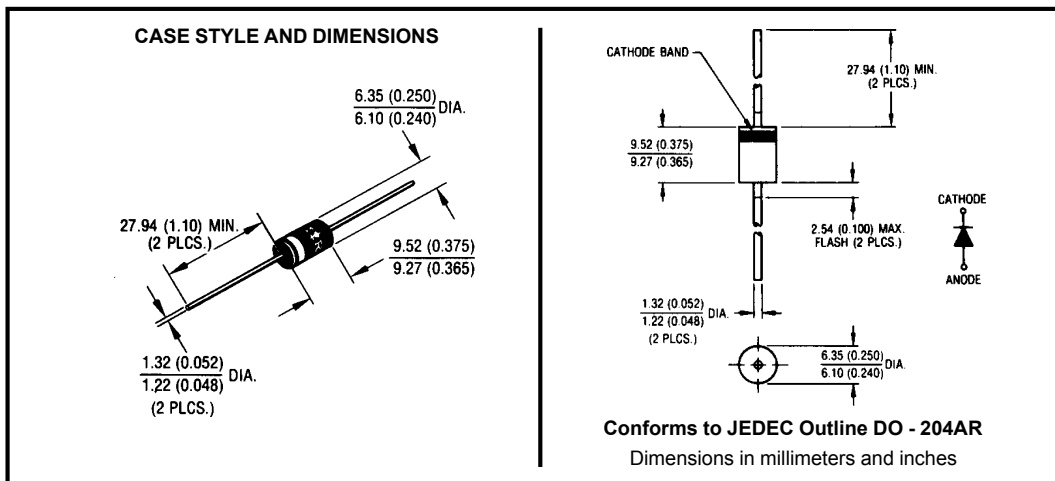

Voltage Ratings

Part number	90SQ030	90SQ035	90SQ040	90SQ045
V_R Max. DC Reverse Voltage (V)	30	35	40	45
V_{RWM} Max. Working Peak Reverse Voltage (V)				

Absolute Maximum Ratings

Parameters	90SQ	Units	Conditions
$I_{F(AV)}$ Max. Average Forward Current * See Fig. 5	9	A	50% duty cycle @ $T_C = 69^\circ\text{C}$, rectangular wave form
I_{FSM} Max. Peak One Cycle Non-Repetitive Surge Current * See Fig. 7	2150	A	Following any rated load condition and with rated V_{RWM} applied
	340		
E_{AS} Non-Repetitive Avalanche Energy	12	mJ	$T_J = 25^\circ\text{C}$, $I_{AS} = 1.8\text{Amps}$, $L = 7.4\text{mH}$
I_{AR} Repetitive Avalanche Current	1.8	A	Current decaying linearly to zero in 1 μsec Frequency limited by T_J max. $V_A = 1.5 \times V_R$ typical

Electrical Specifications

Parameters	90SQ	Units	Conditions
V_{FM} Max. Forward Voltage Drop (1) * See Fig. 1	0.48	V	@ 9A
	0.57	V	@ 18A
	0.42	V	@ 9A
	0.52	V	@ 18A
I_{RM} Max. Reverse Leakage Current (1) * See Fig. 2	1.75	mA	$T_J = 25^\circ\text{C}$
	70	mA	$T_J = 125^\circ\text{C}$
C_T Max. Junction Capacitance	900	pF	$V_R = 5V_{DC}$, (test signal range 100Khz to 1Mhz) 25°C
L_S Typical Series Inductance	10.0	nH	Measured lead to lead 5mm from body
dv/dt Max. Voltage Rate of Change (Rated V_R)	10000	V/ μs	

(1) Pulse Width < 300 μs , Duty Cycle < 2%

Thermal-Mechanical Specifications

Parameters	90SQ	Units	Conditions
T_J Max. Junction Temperature Range	-55 to 150	$^\circ\text{C}$	
T_{stg} Max. Storage Temperature Range	-55 to 150	$^\circ\text{C}$	
R_{thJL} Max. Thermal Resistance Junction to Lead	8.0	$^\circ\text{C/W}$	DC operation * See Fig. 4 1/8 inch lead length
R_{thJA} Typical Thermal Resistance, Junction to Air	44	$^\circ\text{C/W}$	
wt Approximate Weight	1.4(0.049)	g(oz.)	
Case Style	DO-204AR	JEDEC	

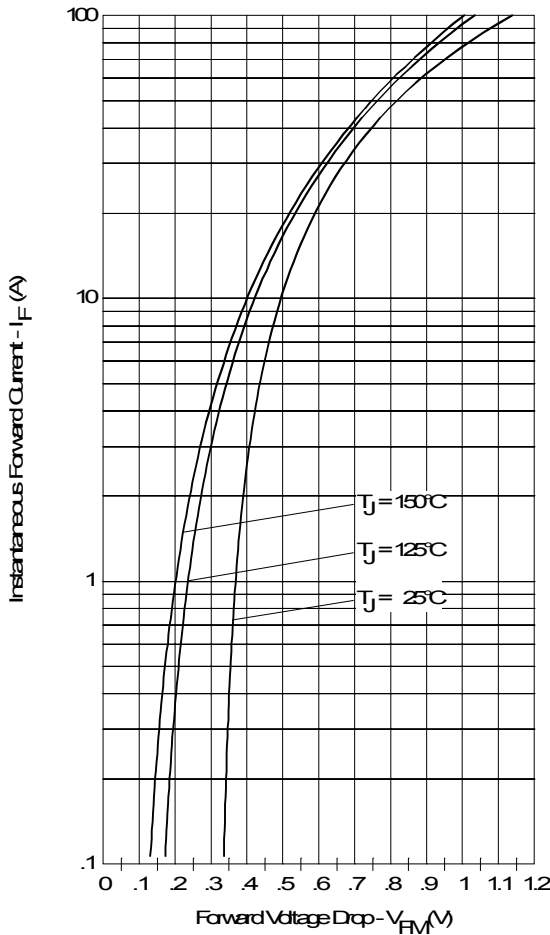

Fig. 1 - Maximum Forward Voltage Drop Characteristics

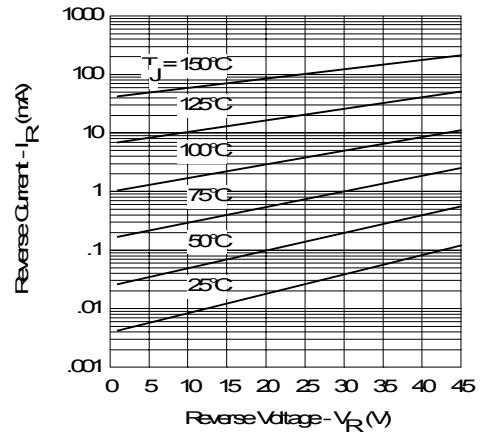

Fig. 2 - Typical Values of Reverse Current Vs. Reverse Voltage

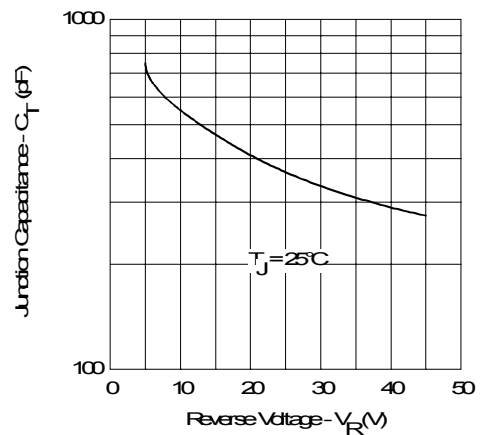

Fig. 3 - Typical Junction Capacitance Vs. Reverse Voltage

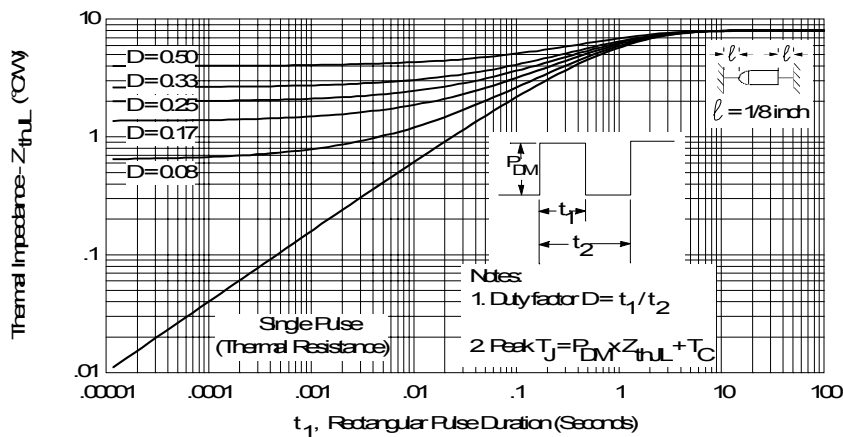

Fig. 4 - Maximum Thermal Impedance Z_{thL} Characteristics

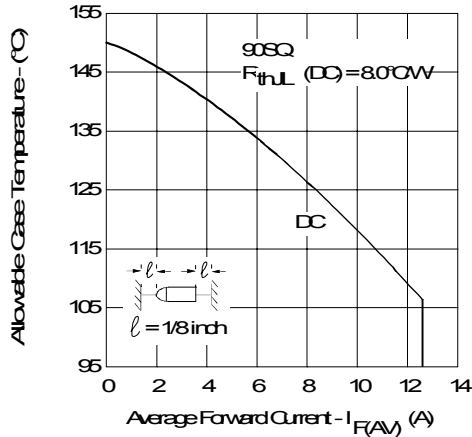

Fig. 5 - Maximum Allowable Case Temperature Vs. Average Forward Current

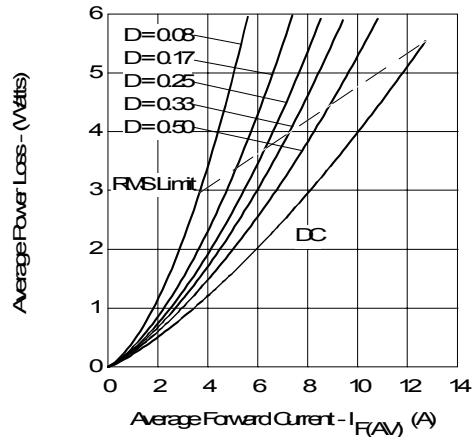

Fig. 6 - Forward Power Loss Characteristics

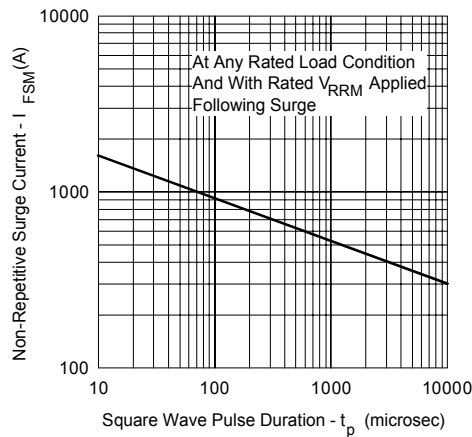

Fig. 7 - Maximum Non-Repetitive Surge Current

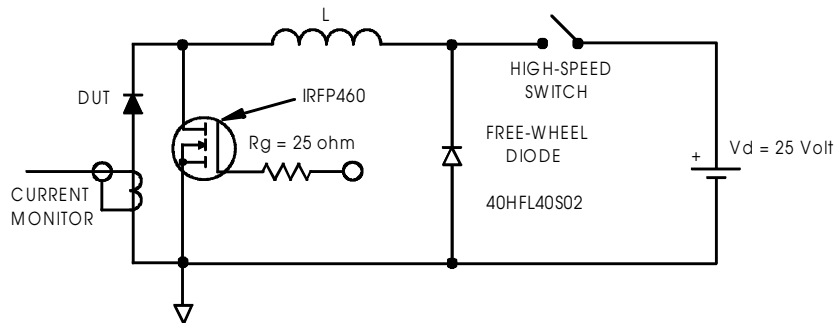

Fig. 8 - Unclamped Inductive Test Circuit

Ordering Information Table

Device Code											
	<table border="1" style="margin: auto;"> <tr> <td style="padding: 5px;">90</td> <td style="padding: 5px;">S</td> <td style="padding: 5px;">Q</td> <td style="padding: 5px;">045</td> <td style="padding: 5px;">TR</td> </tr> <tr> <td style="text-align: center;">①</td> <td style="text-align: center;">②</td> <td style="text-align: center;">③</td> <td style="text-align: center;">④</td> <td style="text-align: center;">⑤</td> </tr> </table>	90	S	Q	045	TR	①	②	③	④	⑤
90	S	Q	045	TR							
①	②	③	④	⑤							
1	- 90 = current x 10										
2	- S = DO-204AR										
3	- Q = Schottky Q Series										
4	- Voltage Rating										
5	- TR = Tape & Reel package (1500 pcs) - = Box package (200 pcs)										
	030 = 30V 035 = 35V 040 = 40V 045 = 45V										

Data and specifications subject to change without notice.
 This product has been designed and qualified for Industrial Level.
 Qualification Standards can be found on IR's Web site.