

International IR Rectifier

HEXFRED™

Features

- Ultrafast Recovery
- Ultrasoft Recovery
- Very Low I_{RRM}
- Very Low Q_{rr}
- Guaranteed Avalanche
- Specified at Operating Conditions
- Lead-Free

Benefits

- Reduced RFI and EMI
- Reduced Power Loss in Diode and Switching Transistor
- Higher Frequency Operation
- Reduced Snubbing
- Reduced Parts Count

Description

International Rectifier's HFA16PB120 is a state of the art center tap ultra fast recovery diode. Employing the latest in epitaxial construction and advanced processing techniques it features a superb combination of characteristics which result in performance which is unsurpassed by any rectifier previously available. With basic ratings of 1200 volts and 16 amps continuous current, the HFA16PB120 is especially well suited for use as the companion diode for IGBTs and MOSFETs. In addition to ultra fast recovery time, the HEXFRED product line features extremely low values of peak recovery current (I_{RRM}) and does not exhibit any tendency to "snap-off" during the t_b portion of recovery. The HEXFRED features combine to offer designers a rectifier with lower noise and significantly lower switching losses in both the diode and the switching transistor. These HEXFRED advantages can help to significantly reduce snubbing, component count and heatsink sizes. The HEXFRED HFA16PB120 is ideally suited for applications in power supplies and power conversion systems (such as inverters), motor drives, and many other similar applications where high speed, high efficiency is needed.

Absolute Maximum Ratings

	Parameter	Max.	Units
V_R	Cathode-to-Anode Voltage	1200	V
$I_F @ T_C = 100^\circ\text{C}$	Continuous Forward Current	30	A
I_{FSM}	Single Pulse Forward Current	120	
I_{FRM}	Maximum Repetitive Forward Current	90	
$P_D @ T_C = 25^\circ\text{C}$	Maximum Power Dissipation	350	W
$P_D @ T_C = 100^\circ\text{C}$	Maximum Power Dissipation	140	
T_J T_{STG}	Operating Junction and Storage Temperature Range	-55 to + 150	$^\circ\text{C}$

* 125°C

www.irf.com

PD -95686A

HFA30PB120PbF

Ultrafast, Soft Recovery Diode

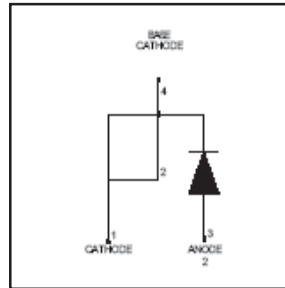

$V_R = 1200\text{V}$
$V_F(\text{typ.})^* = 2.3\text{V}$
$I_{F(AV)} = 30\text{A}$
$Q_{rr}(\text{typ.}) = 120\text{nC}$
$I_{RRM}(\text{typ.}) = 4.7\text{A}$
$t_{rr}(\text{typ.}) = 47\text{ns}$
$di_{(rec)M}/dt(\text{typ.})^* = 240\text{A}/\mu\text{s}$

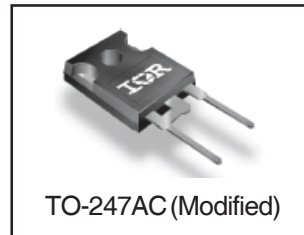

HFA30PB120PbF

International
IRF Rectifier

Electrical Characteristics @ $T_J = 25^\circ\text{C}$ (unless otherwise specified)

Symbol	Parameter	Min.	Typ.	Max.	Units	Conditions
V_{BR}	Cathode Anode Breakdown Voltage	1200	—	—	V	$I_R = 100\mu\text{A}$
V_{FM}	Max Forward Voltage	—	2.4	4.1	V	$I_F = 30\text{A}$
		—	3.1	5.7		$I_F = 60\text{A}$ See Fig. 1
		—	2.3	4.0		$I_F = 30\text{A}, T_J = 125^\circ\text{C}$
I_{RM}	Max Reverse Leakage Current	—	1.3	40	μA	$V_R = V_R$ Rated See Fig. 2
		—	1.1	4000		$T_J = 125^\circ\text{C}, V_R = 0.8 \times V_R$ Rated
C_T	Junction Capacitance	—	50	75	pF	$V_R = 200\text{V}$ See Fig. 3
L_S	Series Inductance	—	8.0	—	nH	Measured lead to lead 5mm from package body

Dynamic Recovery Characteristics @ $T_J = 25^\circ\text{C}$ (unless otherwise specified)

Symbol	Parameter	Min.	Typ.	Max.	Units	Conditions	
t_{rr}	Reverse Recovery Time	—	47	—	ns	$I_F = 1.0\text{A}, di_F/dt = 200\text{A}/\mu\text{s}, V_R = 30\text{V}$	
t_{rr1}	See Fig. 5, 10	—	110	170			$T_J = 25^\circ\text{C}$
t_{rr2}		—	170	260			$T_J = 125^\circ\text{C}$
I_{RRM1}	Peak Recovery Current	—	10	15	A	$I_F = 30\text{A}$	
I_{RRM2}	See Fig. 6	—	16	24			$T_J = 125^\circ\text{C}$
Q_{rr1}	Reverse Recovery Charge	—	650	980	nC	$V_R = 200\text{V}$	
Q_{rr2}	See Fig. 7	—	1540	2310			$T_J = 125^\circ\text{C}$
$di_{(rec)}/dt1$	Peak Rate of Fall of Recovery Current	—	270	—	$\text{A}/\mu\text{s}$	$di_F/dt = 200\text{A}/\mu\text{s}$	
$di_{(rec)}/dt1$	During t_b See Fig. 8	—	240	—			$T_J = 125^\circ\text{C}$

Thermal - Mechanical Characteristics

	Parameter	Min.	Typ.	Max.	Units
$T_{lead}^{(2)}$	Lead Temperature	—	—	300	$^\circ\text{C}$
R_{qJC}	Thermal Resistance, Junction-to-Case	—	—	0.36	$^\circ\text{C}/\text{W}$
$R_{qJA}^{(3)}$	Thermal Resistance, Junction-to-Ambient	—	—	80	
$R_{qCS}^{(4)}$	Thermal Resistance, Case-to-Heat Sink	—	0.50	—	
Wt	Weight	—	2.0 (0.07)	—	g (oz.)
	Mounting Torque	6.0	—	12	kg-cm
		5.0	—	10	lbf-in

Notes:

- ① $L = 100\mu\text{H}$, duty cycle limited by max T_J
- ② 0.063 in. from Case (1.6mm) for 10 sec
- ③ Typical Socket Mount
- ④ Mounting Surface, Flat, Smooth and Greased

HFA30PB120PbF

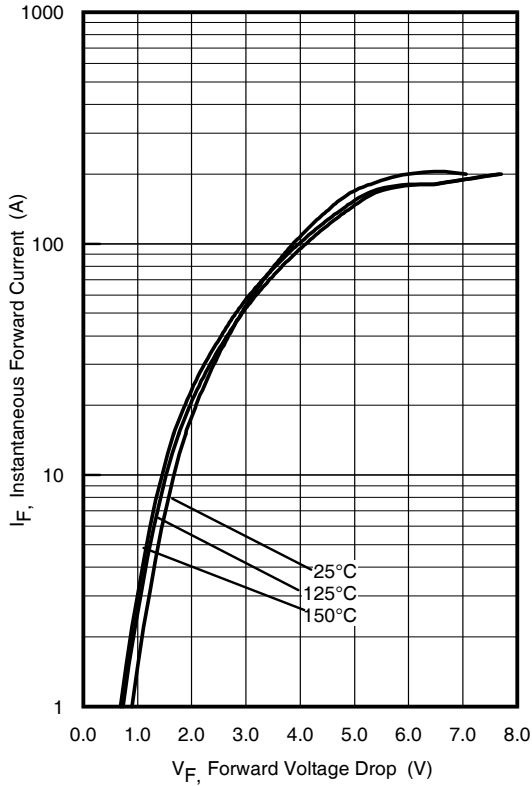

Fig. 1 - Maximum Forward Voltage Drop vs. Instantaneous Forward Current

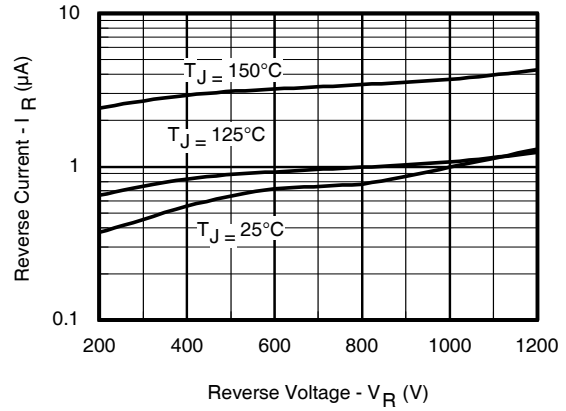

Fig. 2 - Typical Reverse Current vs. Reverse Voltage

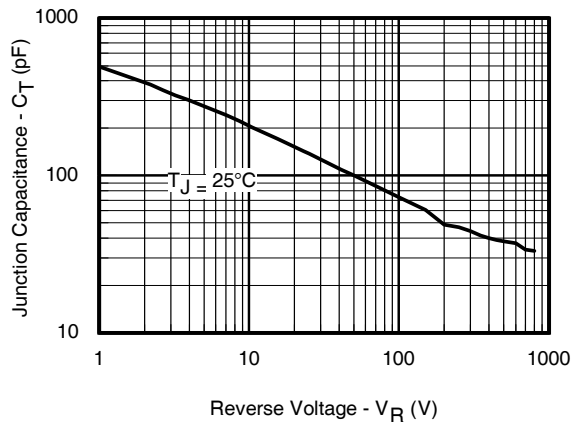

Fig. 3 - Typical Junction Capacitance vs. Reverse Voltage

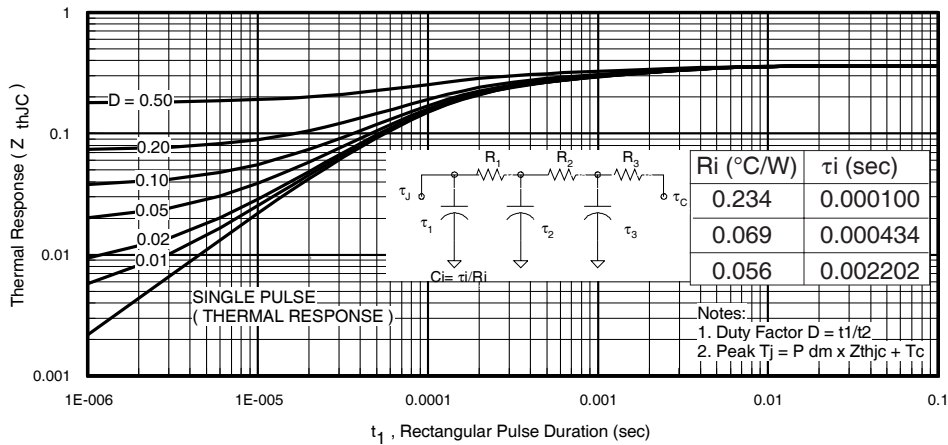

Fig. 4 - Maximum Thermal Impedance Z_{thjc} Characteristics

HFA30PB120PbF

International
IR Rectifier

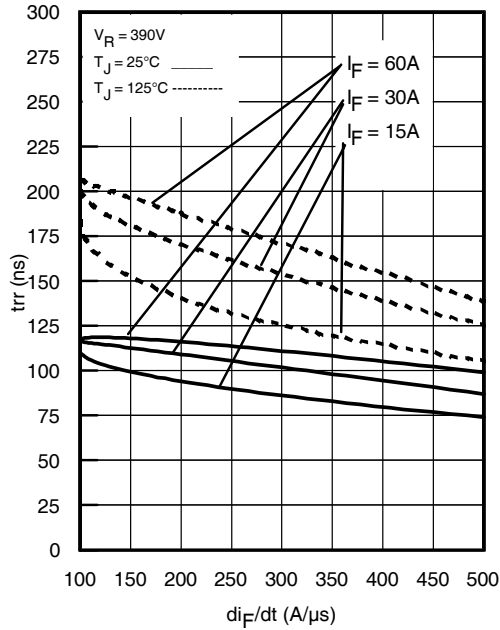

Fig. 5 - Typical Reverse Recovery vs. di_f/dt , (per Leg)

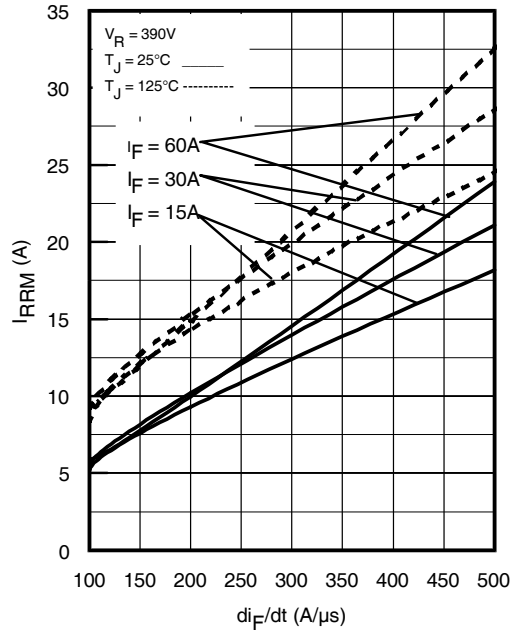

Fig. 6 - Typical Recovery Current vs. di_f/dt , (per Leg)

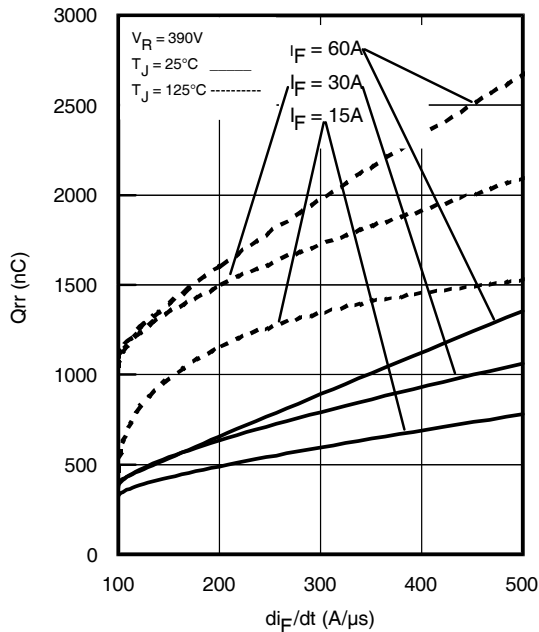

Fig. 7 - Typical Stored Charge vs. di_f/dt , (per Leg)

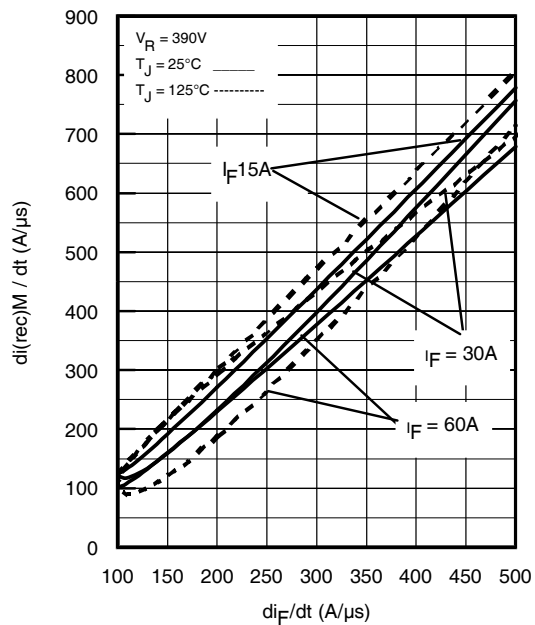

Fig. 8 - Typical $di_{(rec)M}/dt$ vs. di_f/dt , (per Leg)

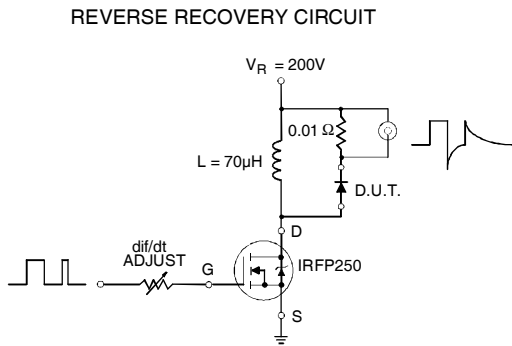

Fig. 9 - Reverse Recovery Parameter Test Circuit

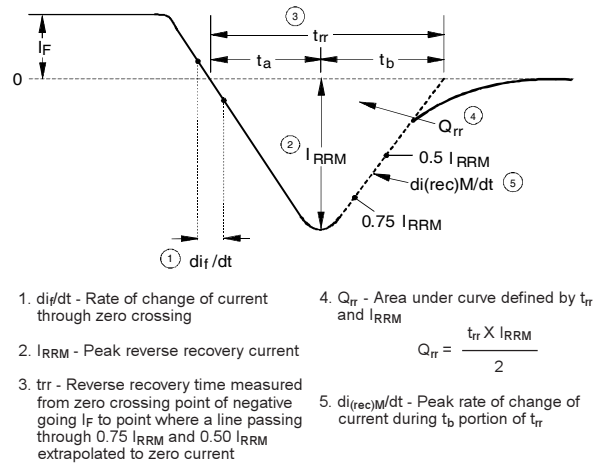

Fig. 10 - Reverse Recovery Waveform and Definitions

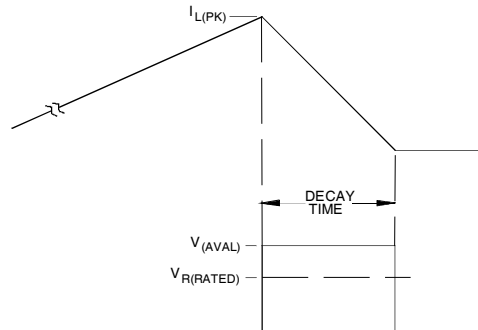
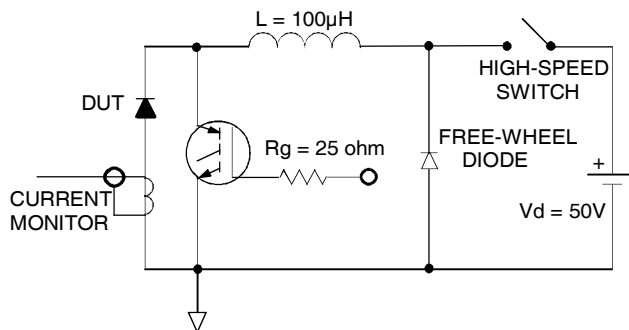

Fig. 11 - Avalanche Test Circuit and Waveforms

HFA30PB120PbF

International
IR Rectifier

TO-247AC (Modified) Package Outline Drawing

Dimensions are in millimeters (inches)

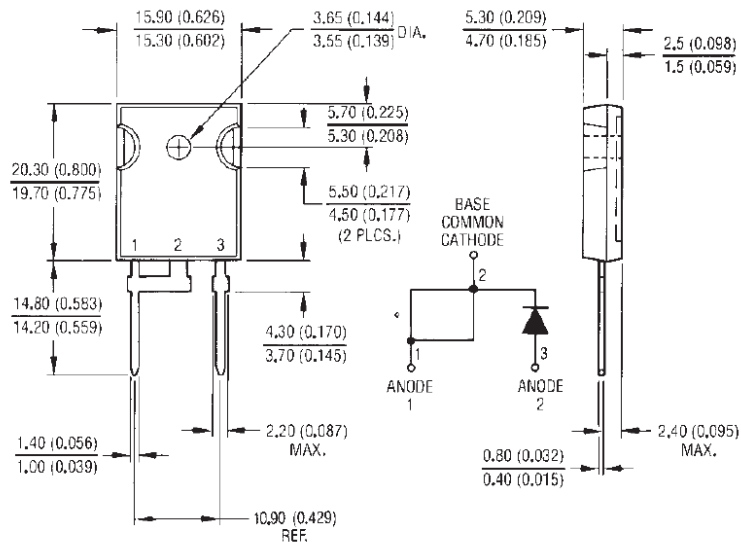

Conforms to JEDEC Outline TO-247AC(Modified)
Dimensions in millimeters and inches

Note: Marking "P" indicates Lead-Free

Data and specifications subject to change without notice.

International
IR Rectifier

IR WORLD HEADQUARTERS: 233 Kansas St., El Segundo, California 90245, USA Tel: (310) 252-7105
TAC Fax: (310) 252-7903

Visit us at www.irf.com for sales contact information.11/04

www.irf.com