

THIS DRAWING IS UNPUBLISHED. RELEASED FOR PUBLICATION
 © COPYRIGHT - By - ALL RIGHTS RESERVED.

REVISIONS				
P	LTR	DESCRIPTION	DATE	APVD
D		REVISED PER ECO-18-001882	12FEB2018	AP DG

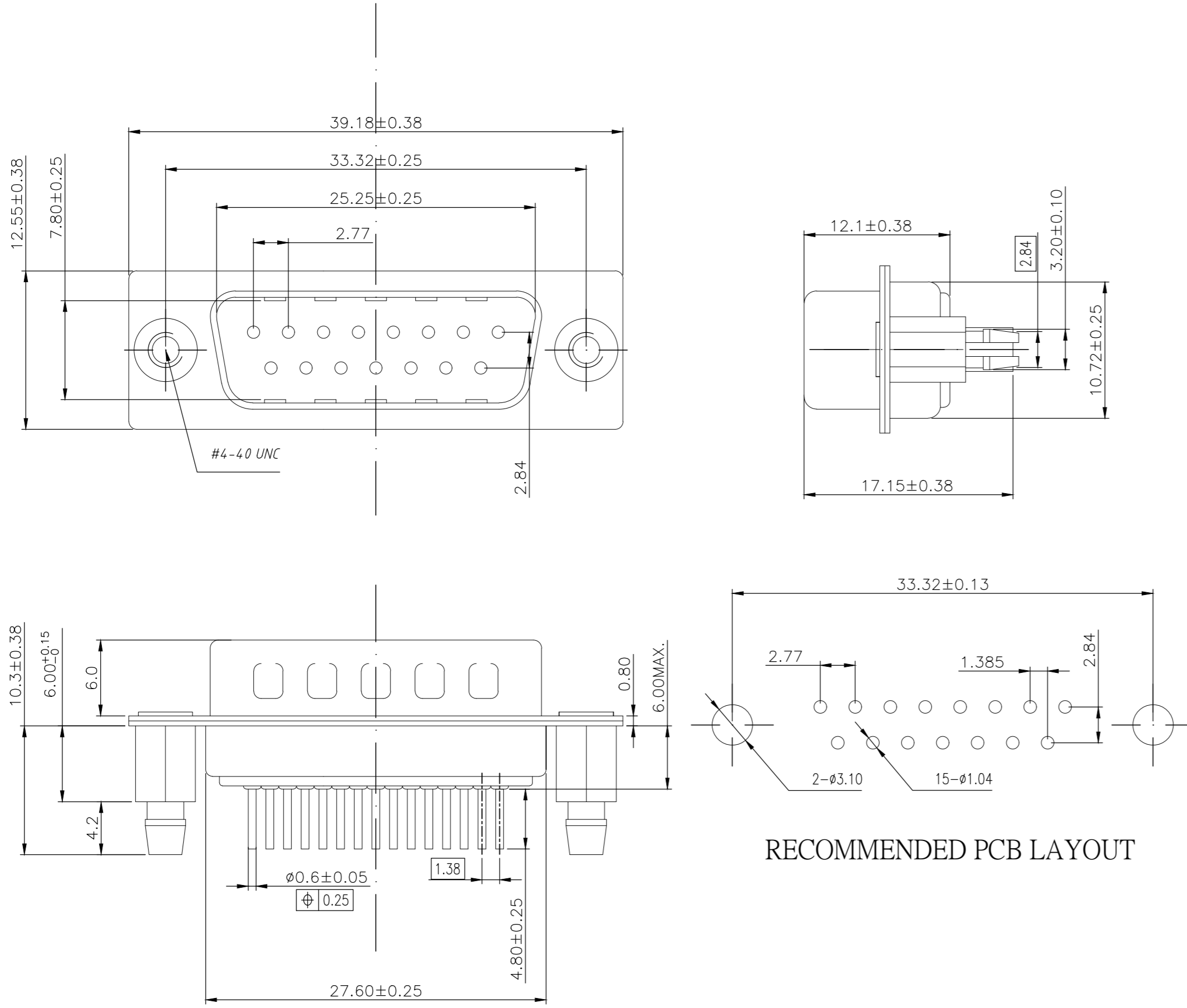

NOTE:

- MATERIAL:**
 HOUSING: PBT WITH 20% GF UL 94 V-0, BLACK COLOR
 CONTACTS: BRASS.
 SHELL: STEEL.
 SCREW: BRASS.
 SCREW LOCK: BRASS.
 SCREW TORQUE: 5kgf-cm MAX.
- FINISH:**
 CONTACTS: GOLD PLATED ON CONTACT AREA,
 0.375µm [15µ"] MIN. MATTE TIN ON SOLDER TAIL
 2.54µm [100µ"], WITH ENTIRE CONTACT
 UNDERPLATED 1.27µm [50µ"] MIN. NICKEL.
 FRONT SHELL: 2.54µm [100µ"] MIN. NICKEL PLATED.
 REAR SHELL: 1.27µm [50µ"] MIN NICKEL UNDERPLATE
 2.54µm [100µ"] MIN BRIGHT TIN PLATE
 SCREW LOCK: 1.27µm [50µ"] MIN. NICKEL PLATED.
 BOARDLOCK: 1.27µm [50µ"] MIN NICKEL UNDERPLATE
 1.27µm [50µ"] MIN MATTE TIN PLATE
- WAVE SOLDER CAPABLE TO 265°C PER TE TEST SPEC. 109-202, CONDITION B.**

RECOMMENDED PCB LAYOUT

THIS DRAWING IS A CONTROLLED DOCUMENT.		DWN	AJITH PAI	06FEB2017	15w D plg W B/L & 4-40 inserts 15u" gold		2301828-1
DIMENSIONS: mm		CHK	DAN GORENC	06FEB2017	DESCRIPTION		TE PART NO
TOLERANCES UNLESS OTHERWISE SPECIFIED:		APVD		06FEB2017			
0 PLC ± -	1 PLC ± 0.25	PRODUCT SPEC	108-130013		NAME		D-SUB VERTICAL
2 PLC ± 0.15	3 PLC ± 0.10	APPLICATION SPEC			DESCRIPTION		15P PLUG CONNECTOR
4 PLC ± -	ANGLES ± 2°	WEIGHT	0		SIZE	CAGE CODE	DRAWING NO
MATERIAL	FINISH	CUSTOMER DRAWING			A2	00779	C=2301828
		SCALE	3:1		SHEET	1 of 3	
		REV	D				

THIS DRAWING IS UNPUBLISHED. RELEASED FOR PUBLICATION
 © COPYRIGHT - By - ALL RIGHTS RESERVED.

REVISIONS					
P	LTR	DESCRIPTION	DATE	DWN	APVD
-	-	SEE SHEET 1	-	-	-

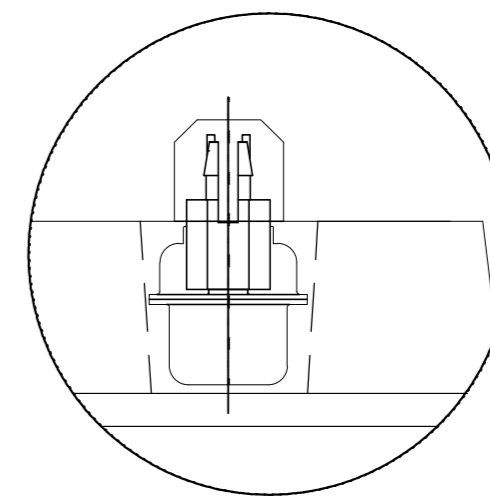
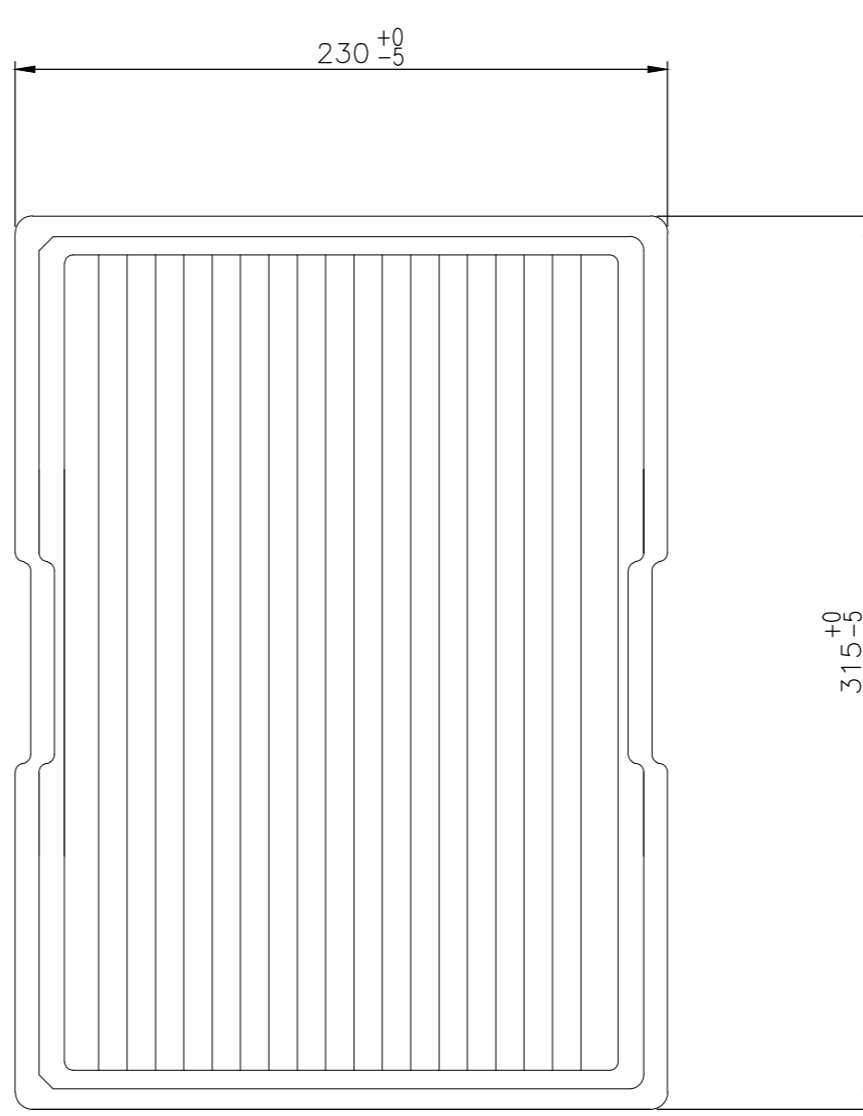
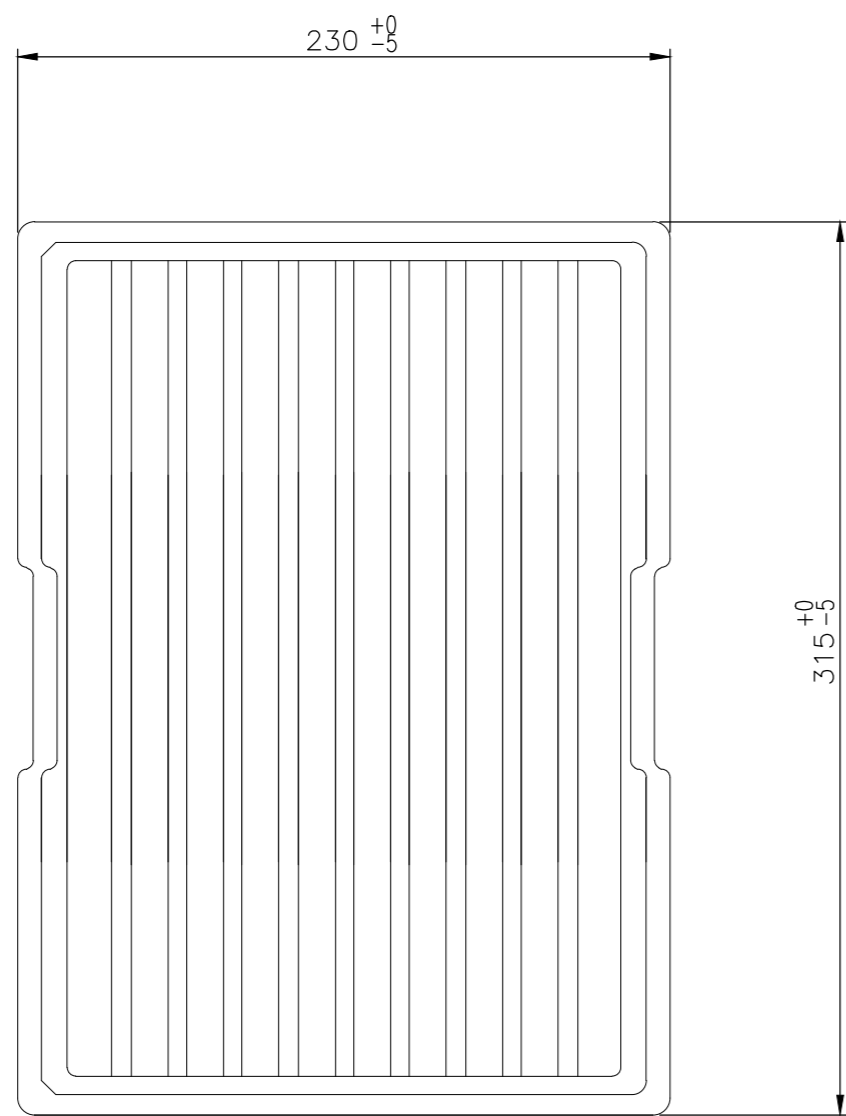
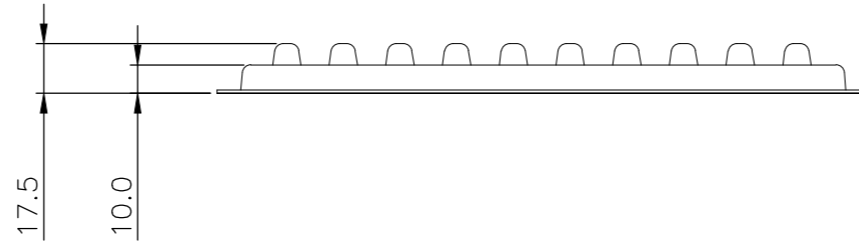
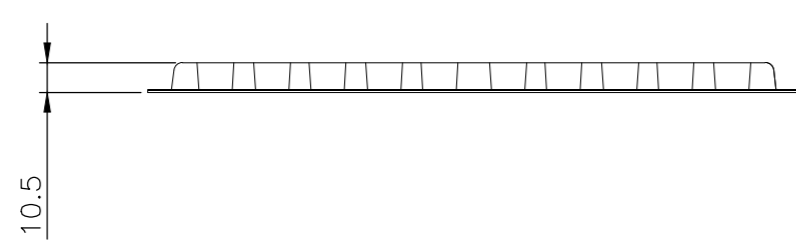

DETAIL A

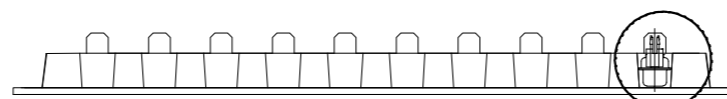

SEE DETAIL A

THIS DRAWING IS A CONTROLLED DOCUMENT.		DWN AJITH PAI 06FEB2017	TE TE Connectivity		
DIMENSIONS: mm		CHK DAN GORENC 06FEB2017			
TOLERANCES UNLESS OTHERWISE SPECIFIED:		APVD - 06FEB2017	NAME D-SUB VERTICAL 15P PLUG CONNECTOR		
0 PLC ± - 1 PLC ± 0.25 2 PLC ± 0.15 3 PLC ± 0.10 4 PLC ± - ANGLES ± -		PRODUCT SPEC 108-130013	SIZE A2	CAGE CODE 00779	DRAWING NO C=2301828
MATERIAL -		FINISH -	WEIGHT 0	RESTRICTED TO -	
CUSTOMER DRAWING			SCALE 1:1	SHEET 2 of 3	REV D

THIS DRAWING IS UNPUBLISHED. RELEASED FOR PUBLICATION
 © COPYRIGHT - By - ALL RIGHTS RESERVED.

REVISIONS					
P	LTR	DESCRIPTION	DATE	DWN	APVD
-	-	SEE SHEET 1	-	-	-

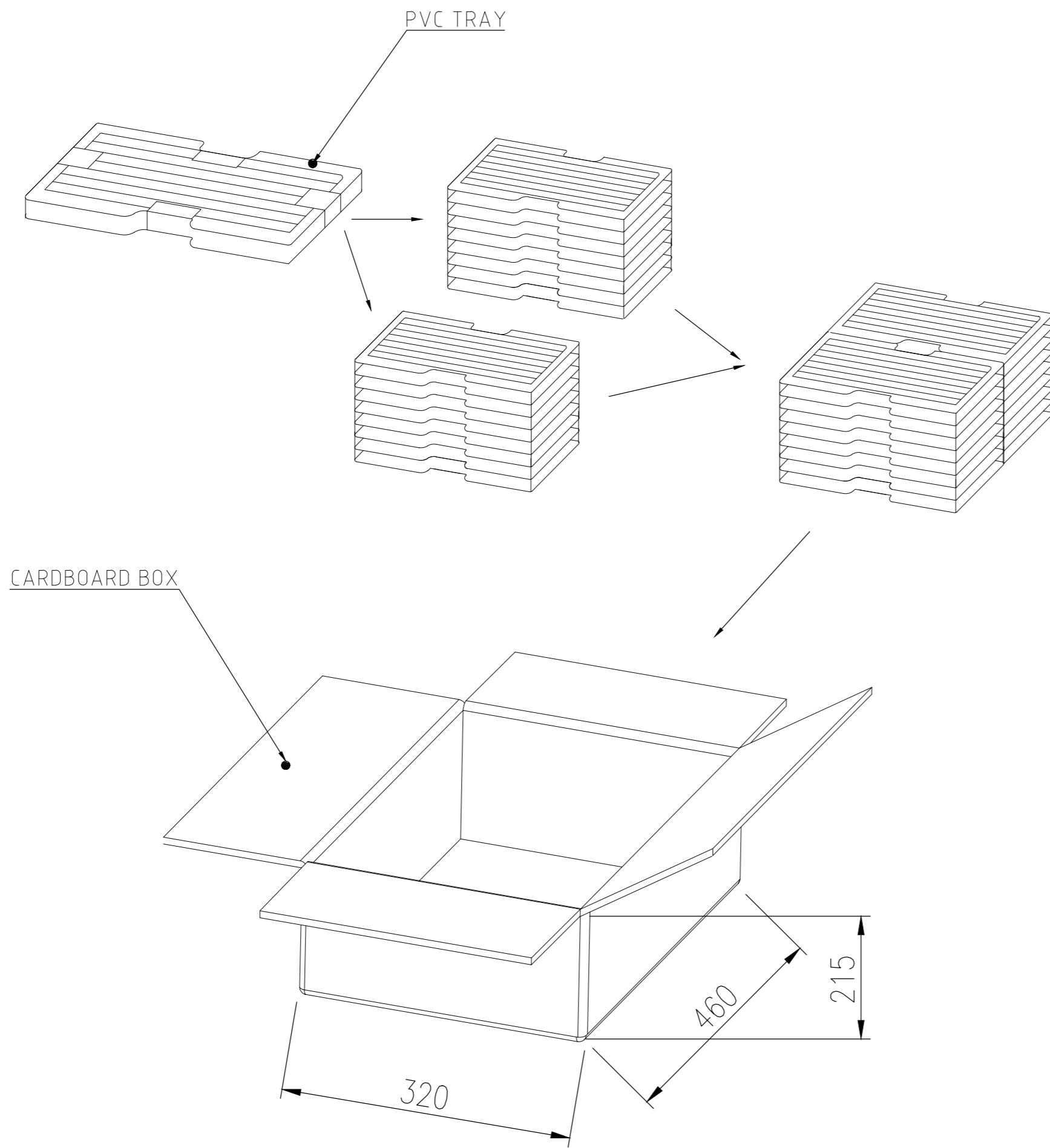

12.911	10.332	70	20	1400	2301828-1
GROSS WEIGHT (Kg)	NET WEIGHT (Kg)	PCS/TRAY	TRAYS /CARTON	QUANTITY PCS	PART NUMBER

THIS DRAWING IS A CONTROLLED DOCUMENT.		DWN 06FEB2017 AJITH PAI			
DIMENSIONS: mm		CHK 06FEB2017 DAN GORENC			
TOLERANCES UNLESS OTHERWISE SPECIFIED:		APVD 06FEB2017	NAME		
0 PLC ± -		PRODUCT SPEC	D-SUB VERTICAL		
1 PLC ± 0.25		108-130013	15P PLUG CONNECTOR		
2 PLC ± 0.15		APPLICATION SPEC	-		
3 PLC ± 0.10			SIZE	CAGE CODE	DRAWING NO
4 PLC ± -			A2	00779	C=2301828
ANGLES ± -		WEIGHT	RESTRICTED TO		
FINISH		0	-		
MATERIAL		CUSTOMER DRAWING	SCALE	SHEET	REV
			1:1	3 of 3	D

2301828

Mouser Electronics

Authorized Distributor

Click to View Pricing, Inventory, Delivery & Lifecycle Information:

[TE Connectivity:](#)

[2301828-1](#)