

LM48824 Boomer® Audio Power Amplifier Series **Class G Headphone Amplifier** with I²C Volume Control

Check for Samples: [LM48824](#)

FEATURES

- **Class G Power Savings**
- **Ground Referenced Headphone Outputs – Eliminates Output Coupling Capacitors**
- **Common-Mode Sense**
- **I²C Volume and Mode Control**
- **High Output Impedance in Shutdown**
- **Differential Inputs**
- **Advanced Click-and-Pop Suppression**
- **Low Supply Current**
- **Low THD Mode Option**

APPLICATIONS

- **Mobile Phones, PDAs, MP3 Players**
- **Portable Electronic Devices, Notebook PCs**

KEY SPECIFICATIONS

- **Quiescent Power Supply Current at 3.6V: 0.9mA (typ)**
- **Output Power/Channel at V_{DD} = 3.6V (R_L = 16Ω, THD+N ≤ 1%): 37 mW (Typ)**
- **Output Power/Channel at V_{DD} = 3.6V (R_L = 32Ω, THD+N ≤ 1%): 29 mW (Typ)**
- **PSRR at 217Hz: 100 dB (Typ)**
- **Shutdown Current: 2.5 μA (Typ)**

Simplified Block Diagram

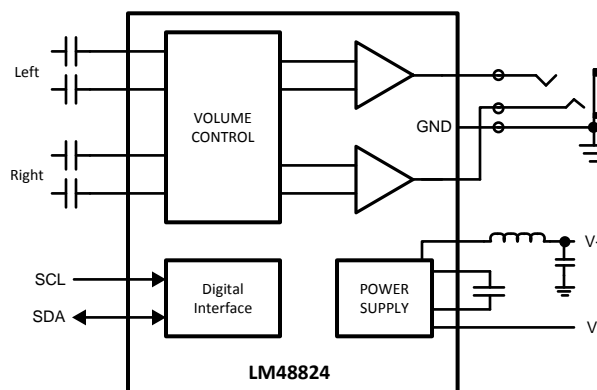

DESCRIPTION

The LM48824 is a Class G, ground-referenced stereo headphone amplifier designed for portable devices. The LM48824 features TI's ground-referenced architecture, which eliminates the large DC blocking capacitors required by traditional headphone amplifiers, saving board space and minimizing system cost.

The LM48824 takes advantage of TI's patent-pending Class G architecture offering power savings compared to a traditional Class AB headphone amplifier. Additionally, output noise is improved by common-mode sensing that corrects for any differences between the amplifier ground and the potential at the headphone return terminal, minimizing noise created by any ground mismatches.

A high output impedance mode allows the LM48824's outputs to be driven by an external source without degrading the signal. Other features include flexible power supply requirements, differential inputs for improved noise rejection, a low power (2.5μA) shutdown mode, and a 32-step I²C volume control with mute function.

The LM48824's superior click and pop suppression eliminates audible transients on power-up/down and during shutdown. The LM48824 is available in an ultra-small 16-bump, 0.4mm pitch DSBGA package (1.69mm x 1.69mm)



Please be aware that an important notice concerning availability, standard warranty, and use in critical applications of Texas Instruments semiconductor products and disclaimers thereto appears at the end of this data sheet.

All trademarks are the property of their respective owners.

Typical Application

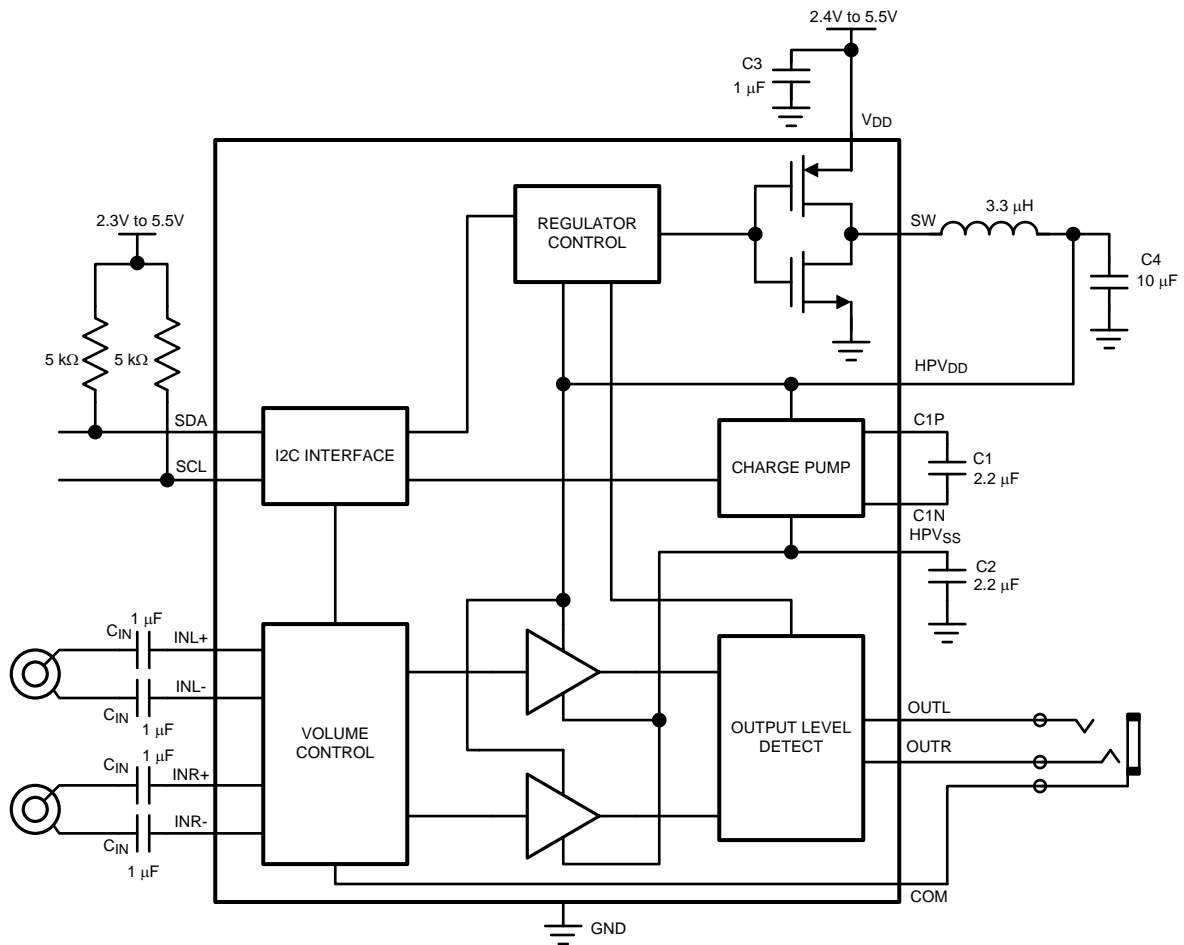

Figure 1. Typical Audio Amplifier Application Circuit

Connection Diagram

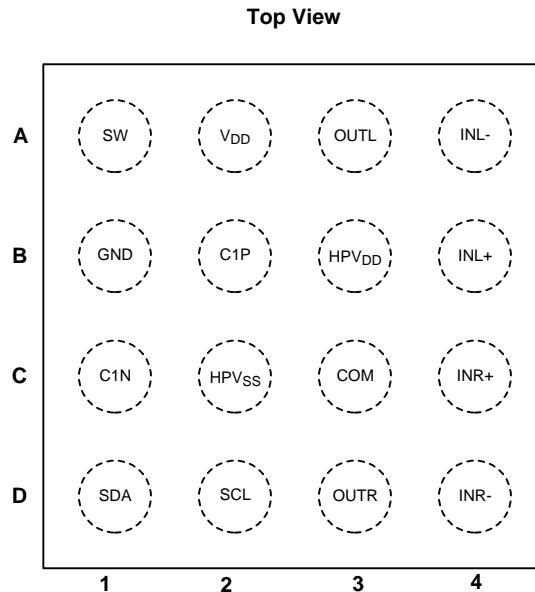

Figure 2.
DSBGA Package (1.7mm x 1.7mm x 0.6mm)
See Package Number YFQ0016DDA



These devices have limited built-in ESD protection. The leads should be shorted together or the device placed in conductive foam during storage or handling to prevent electrostatic damage to the MOS gates.

Absolute Maximum Ratings⁽¹⁾⁽²⁾⁽³⁾⁽⁴⁾

Supply Voltage ⁽¹⁾		6V
Storage Temperature		-65°C to +150°C
Input Voltage		-0.3V to V _{DD} + 0.3V
Power Dissipation ⁽⁵⁾		Internally Limited
ESD Rating ⁽⁶⁾		2000V
ESD Rating ⁽⁷⁾		200V
ESD Rating ⁽⁸⁾		500V
Junction Temperature		150°C
Soldering Information	Vapor Phase (60 sec.)	215°C
	Infrared (15 sec.)	220°C
Thermal Resistance	θ _{JA} (YFQ0016DDA)	60°C/W

- (1) Absolute Maximum Ratings indicate limits beyond which damage to the device may occur, including inoperability and degradation of device reliability and/or performance. Functional operation of the device and/or non-degradation at the Absolute Maximum Ratings or other conditions beyond those indicated in the Recommended Operating Conditions is not implied. The Recommended Operating Conditions indicate conditions at which the device is functional and the device should not be operated beyond such conditions. All voltages are measured with respect to the ground pin, unless otherwise specified.
- (2) The Electrical Characteristics tables list specified specifications under the listed Recommended Operating Conditions except as otherwise modified or specified by the Electrical Characteristics Conditions and/or Notes. Typical specifications are estimations only and are not ensured.
- (3) Soldering Information: See [AN-1112](#) "Micro SMD Wafer Level Chip Scale package"
- (4) If Military/Aerospace specified devices are required, please contact the Texas Instruments Sales Office/Distributors for availability and specifications.
- (5) The maximum power dissipation must be derated at elevated temperatures and is dictated by T_{JMAX}, θ_{JA}, and the ambient temperature, T_A. The maximum allowable power dissipation is P_{DMAX} = (T_{JMAX} - T_A) / θ_{JA} or the number given in Absolute Maximum Ratings, whichever is lower.
- (6) Human body model, applicable std. JESD22-A114C.
- (7) Machine model, applicable std. JESD22-A115-A.
- (8) Charged Device Model, applicable std. JESD22-C101-C.

Operating Ratings

Temperature Range ($T_{MIN} \leq T_A \leq T_{MAX}$)	$-40^{\circ}\text{C} \leq T_A \leq +85^{\circ}\text{C}$
Supply Voltage (V_{DD})	$2.4\text{V} \leq V_{DD} \leq 5.5\text{V}$

Electrical Characteristics $V_{DD} = 3.6\text{V}^{(1)(2)}$

The following specifications apply for $A_V = 0\text{dB}$, $R_L = 32\Omega$, $f = 1\text{kHz}$, unless otherwise specified. Limits apply to $T_A = 25^{\circ}\text{C}$.

Parameter		Test Conditions	LM48824		Units (Limits)
			Typ ⁽³⁾	Limit ⁽⁴⁾	
I_{DD}	Quiescent Power Supply Current	$V_{IN} = 0\text{V}$, both channels active, $R_L = \infty$	0.9	1.3	mA (max)
		$R_L = \infty$, Low THD mode	1.55		mA
$I_{DD(OP)}$	Operating Power Supply Current	$P_O = 100\mu\text{W}$, two channels in phase, 3dB Crest Factor, $R_L = 32\Omega + 15\Omega$	1.8	2.5	mA (max)
		$P_O = 100\mu\text{W}$, two channels in phase, 3dB Crest Factor, $R_L = 32\Omega + 15\Omega$, Low THD mode	2.2		mA
		$P_O = 500\mu\text{W}$, two channels in phase, 3dB Crest Factor $R_L = 32\Omega + 15\Omega$	3.1	3.8	mA (max)
		$P_O = 500\mu\text{W}$, two channels in phase, 3dB Crest Factor $R_L = 32\Omega + 15\Omega$, Low THD mode	3.4		mA
		$P_O = 1\text{mW}$, two channels in phase, 3dB Crest Factor, $R_L = 32\Omega + 15\Omega$	4.1	4.9	mA (max)
		$P_O = 1\text{mW}$, two channels in phase, 3dB Crest Factor, $R_L = 32\Omega + 15\Omega$, Low THD mode	4.4		mA
I_{SD}	Shutdown Current	Shutdown Enabled, $V_{SCL} = V_{SDA} = 1.8\text{V}$	2.5	3.9	μA (max)
V_{OS}	Output Offset Voltage	$V_{IN} = 0\text{V}$	0.15	0.65	mV (max)
T_{WU}	Wake Up Time	From Shutdown	2		ms
A_V	Gain	Minimum Gain Setting	-59	-58 -60	dB (max) dB (min)
		Maximum Gain Setting	4	4.5 3.5	dB (max) dB (min)
$A_{V(MUTE)}$	Mute Attenuation		-110		dB
R_{IN}	Input Resistance	$A_V = 4\text{dB}$	24	20	k Ω (min)
		$A_V = -59\text{dB}$	64	80	k Ω (max)
P_O	Output Power	$f = 1\text{kHz}$, THD+N = 1% Two channels in phase, $R_L = 16\Omega$	37	30	mW (min)
		$f = 1\text{kHz}$, THD+N = 1% Two channels in phase, $R_L = 32\Omega$	29	23	mW (min)
V_O	Output Swing	THD+N = 1%, Two Channels in Phase			
		$R_L = 16\Omega$	0.77	0.7	V_{RMS} (min)
		$R_L = 32\Omega$	0.96	0.86	V_{RMS} (min)
		$R_L = 32\Omega + 15\Omega$	1.05		V_{RMS}
		$R_L = 10\text{k}\Omega$	1.3	1.1	V_{RMS} (min)

- (1) Absolute Maximum Ratings indicate limits beyond which damage to the device may occur, including inoperability and degradation of device reliability and/or performance. Functional operation of the device and/or non-degradation at the Absolute Maximum Ratings or other conditions beyond those indicated in the Recommended Operating Conditions is not implied. The Recommended Operating Conditions indicate conditions at which the device is functional and the device should not be operated beyond such conditions. All voltages are measured with respect to the ground pin, unless otherwise specified.
- (2) The Electrical Characteristics tables list specified specifications under the listed Recommended Operating Conditions except as otherwise modified or specified by the Electrical Characteristics Conditions and/or Notes. Typical specifications are estimations only and are not ensured.
- (3) Typical values represent most likely parametric norms at $T_A = +25^{\circ}\text{C}$, and at the Recommended Operation Conditions at the time of product characterization and are not ensured.
- (4) Datasheet min/max specification limits are specified by test or statistical analysis.

Electrical Characteristics $V_{DD} = 3.6V^{(1)(2)}$ (continued)

 The following specifications apply for $A_V = 0dB$, $R_L = 32\Omega$, $f = 1kHz$, unless otherwise specified. Limits apply to $T_A = 25^\circ C$.

Parameter		Test Conditions	LM48824		Units (Limits)
			Typ ⁽³⁾	Limit ⁽⁴⁾	
THD+N	Total Harmonic Distortion + Noise	f = 1kHz, Single Channel			
		$V_O = 600mV_{RMS}$, $R_L = 16\Omega$	0.05		%
		$V_O = 600mV_{RMS}$, $R_L = 16\Omega$, Low THD Mode	0.03		%
		$V_O = 800mV_{RMS}$, $R_L = 32\Omega$	0.035		%
		$V_O = 800mV_{RMS}$, $R_L = 32\Omega$, Low THD Mode	0.02		%
		$V_O = 900mV_{RMS}$, $R_L = 32\Omega + 15\Omega$	0.027	0.04	%(max)
PSRR	Power Supply Rejection Ratio	$V_{RIPPLE} = 200mV_{P-P}$, Inputs AC GND, $C_{IN} = 1\mu F$, input referred			
		$f_{RIPPLE} = 217Hz$	100	94	dB (min)
		$f_{RIPPLE} = 1kHz$	100		dB
CMRR	Common Mode Rejection Ratio	$V_{RIPPLE} = 1V_{P-P}$, $f_{RIPPLE} = 217Hz$	60		dB
X_{TALK}	Crosstalk	$R_L \geq 16\Omega$, $P_O = 5mW$, $f = 1kHz$	80	70	dB (min)
		$R_L \geq 10k\Omega$, $V_{OUT} = 1V_{RMS}$, $f = 1kHz$	110	95	dB (min)
SNR	Signal-to-Noise Ratio	$V_{OUT} = 1V_{RMS}$, $f = 1kHz$	102	98	dB (min)
		$V_{OUT} = 1V_{RMS}$, $f = 1kHz$, Low THD Mode	105		dB
ϵ_{OS}	Output Noise	$A_V = 4dB$, A-Weighted Filter	8	12	μV (max)
		$A_V = 4dB$, A-weighted Filter, Low THD Mode	7		μV
R_{OUT}	Output Impedance	Charge pump-only mode enabled			
		f < 40kHz	43	30	k Ω (min)
		f = 6MHz		500	Ω (min)
		f = 36MHz		75	Ω (min)
C_L	Maximum Capacitive Load	No Sustained Oscillations			
		with 5 Ω series resistance	100		nF
		with no series resistance	100		pF
V_{OUT}	Maximum Voltage Swing	Voltage applied to amplifier outputs in charge pump-only mode	1.1	1.0	V_{RMS} (min)

I²C Interface Characteristics $V_{DD} = 3.6V^{(1)(2)}$

The following specifications apply for $A_V = 0dB$, $R_L = 16\Omega$, $f = 1kHz$, unless otherwise specified. Limits apply to $T_A = 25^\circ C$.

Parameter		Test Conditions	LM48824		Units (Limits)
			Typ ⁽³⁾	Limit ⁽⁴⁾	
t_1	SCL Period			2.5	μs (min)
t_2	SDA Setup Time			250	ns (min)
t_3	SDA Stable Time			250	ns (min)
t_4	Start Condition Time			250	ns (min)
t_5	Stop Condition Time			250	ns (min)
V_{IH}	Input High Voltage			1.2	V (min)
V_{IL}	Input Low Voltage			0.6	V (max)

- (1) Absolute Maximum Ratings indicate limits beyond which damage to the device may occur, including inoperability and degradation of device reliability and/or performance. Functional operation of the device and/or non-degradation at the Absolute Maximum Ratings or other conditions beyond those indicated in the Recommended Operating Conditions is not implied. The Recommended Operating Conditions indicate conditions at which the device is functional and the device should not be operated beyond such conditions. All voltages are measured with respect to the ground pin, unless otherwise specified
- (2) The Electrical Characteristics tables list specified specifications under the listed Recommended Operating Conditions except as otherwise modified or specified by the Electrical Characteristics Conditions and/or Notes. Typical specifications are estimations only and are not ensured.
- (3) Typical values represent most likely parametric norms at $T_A = +25^\circ C$, and at the Recommended Operation Conditions at the time of product characterization and are not ensured.
- (4) Datasheet min/max specification limits are specified by test or statistical analysis.

Typical Performance Characteristics

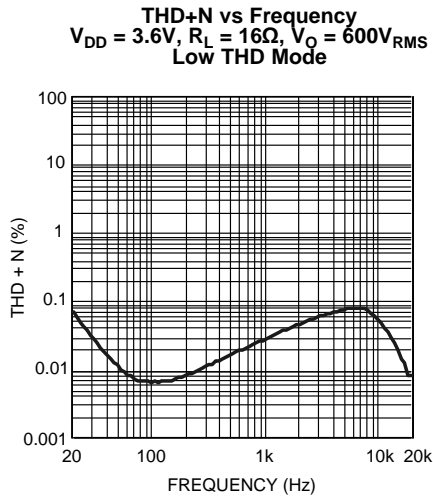

Figure 3.

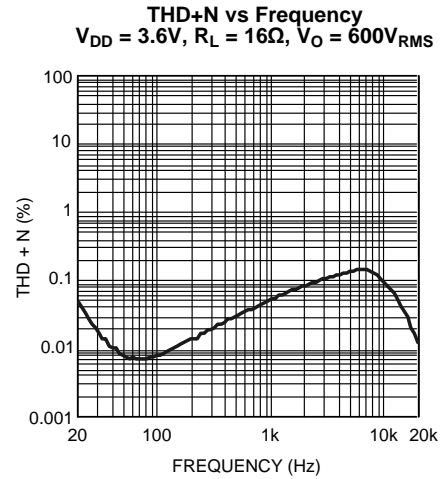

Figure 4.

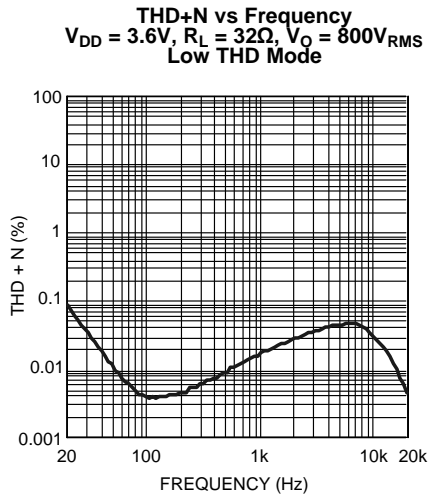

Figure 5.

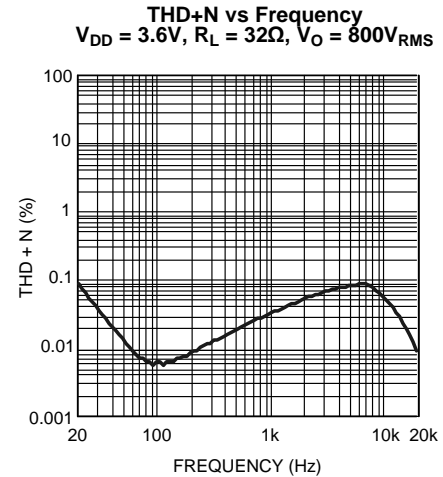

Figure 6.

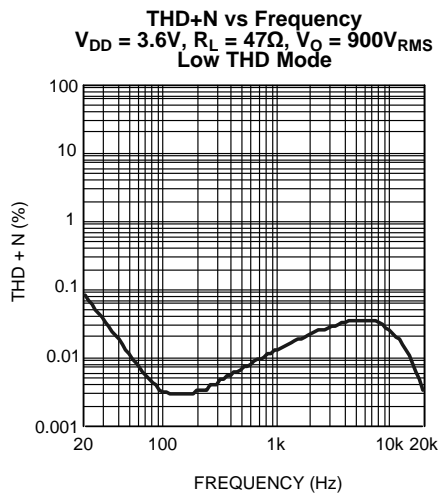

Figure 7.

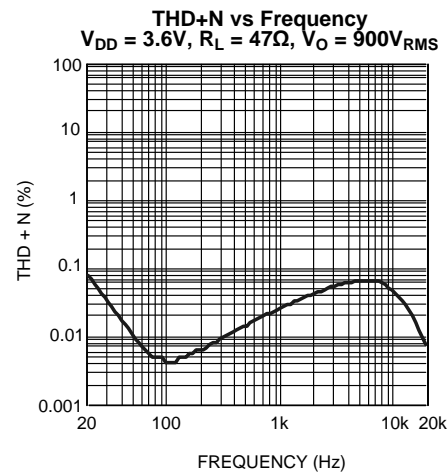

Figure 8.

Typical Performance Characteristics (continued)

THD+N vs Output Voltage
 $V_{DD} = 3.6V, R_L = 16\Omega, f = 1kHz$
 Low THD Mode

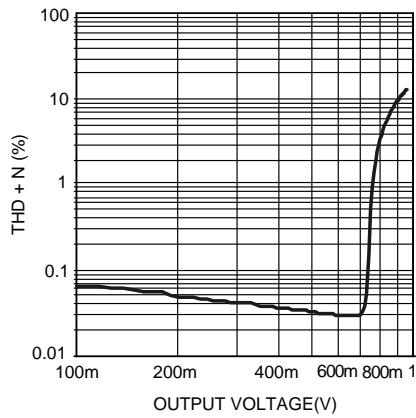

Figure 9.

THD+N vs Output Voltage
 $V_{DD} = 3.6V, R_L = 16\Omega, f = 1kHz$

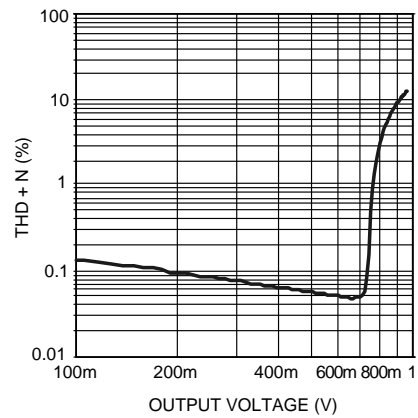

Figure 10.

THD+N vs Output Voltage
 $V_{DD} = 3.6V, R_L = 32\Omega, f = 1kHz$
 Low THD Mode

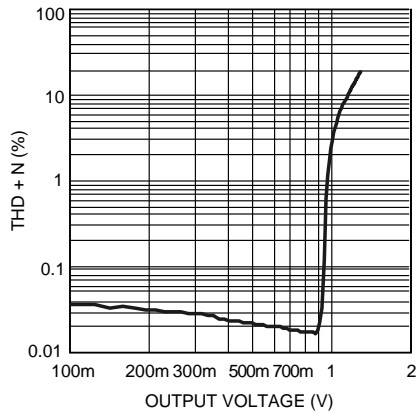

Figure 11.

THD+N vs Output Voltage
 $V_{DD} = 3.6V, R_L = 32\Omega, f = 1kHz$

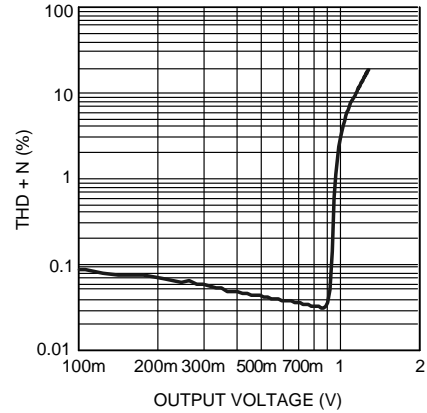

Figure 12.

THD+N vs Output Voltage
 $V_{DD} = 3.6V, R_L = 47\Omega, f = 1kHz$
 Low THD Mode

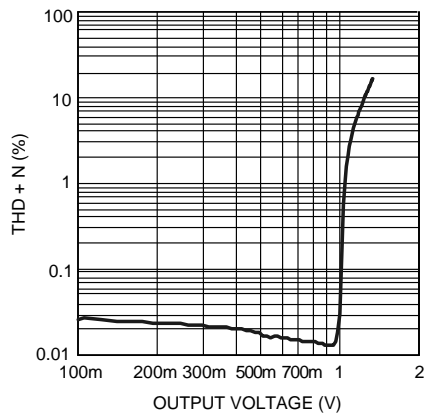

Figure 13.

THD+N vs Output Voltage
 $V_{DD} = 3.6V, R_L = 47\Omega, f = 1kHz$

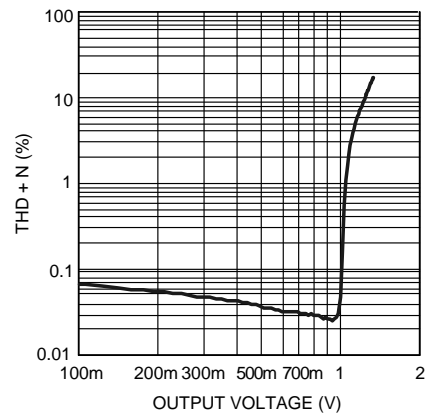

Figure 14.

Typical Performance Characteristics (continued)

THD+N vs Output Power
 $V_{DD} = 3.6V$, $R_L = 16\Omega$, $f = 1kHz$
 Low THD Mode

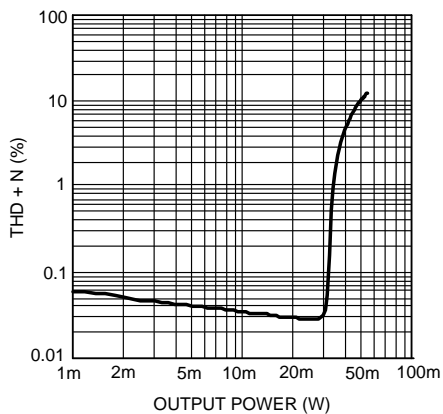

Figure 15.

THD+N vs Output Power
 $V_{DD} = 3.6V$, $R_L = 16\Omega$, $f = 1kHz$

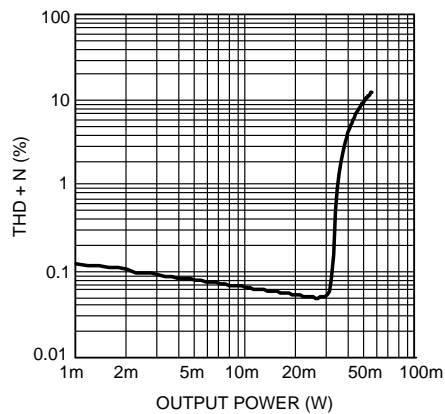

Figure 16.

THD+N vs Output Power
 $V_{DD} = 3.6V$, $R_L = 32\Omega$, $f = 1kHz$
 Low THD Mode

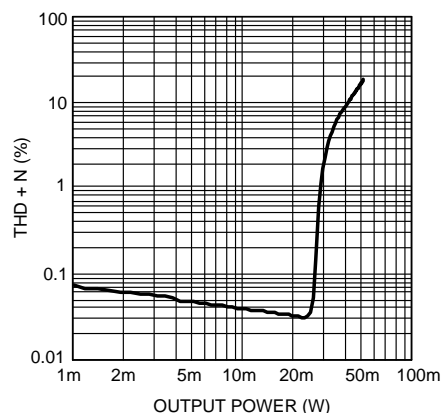

Figure 17.

THD+N vs Output Power
 $V_{DD} = 3.6V$, $R_L = 32\Omega$, $f = 1kHz$

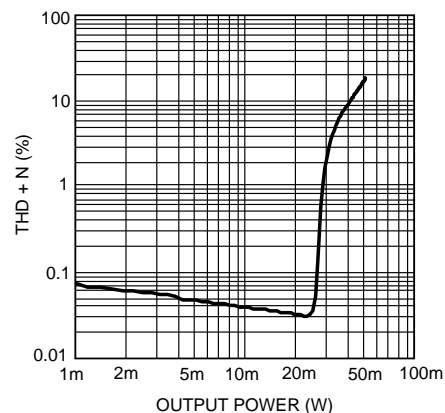

Figure 18.

Power Dissipation vs Output Power
 $V_{DD} = 3.6V$, $R_L = 16\Omega$, $f = 1kHz$

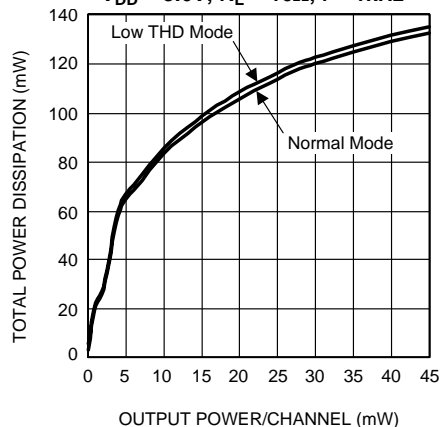

Figure 19.

Power Dissipation vs Output Power
 $V_{DD} = 3.6V$, $R_L = 32\Omega$, $f = 1kHz$

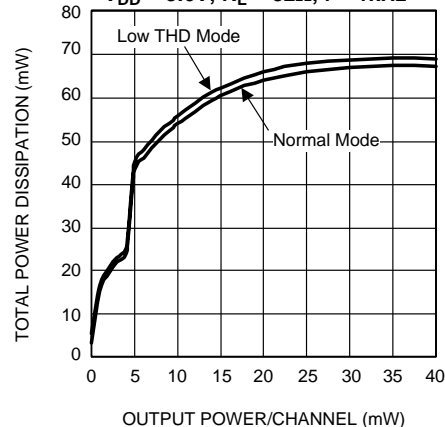

Figure 20.

Typical Performance Characteristics (continued)

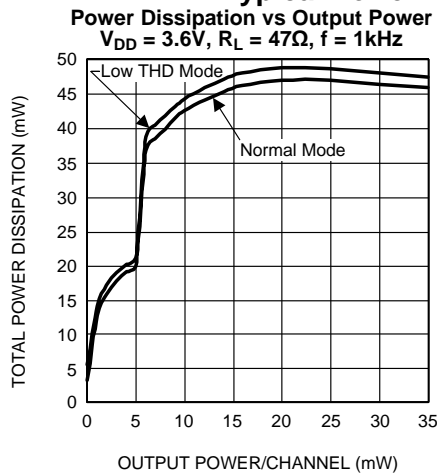

Figure 21.

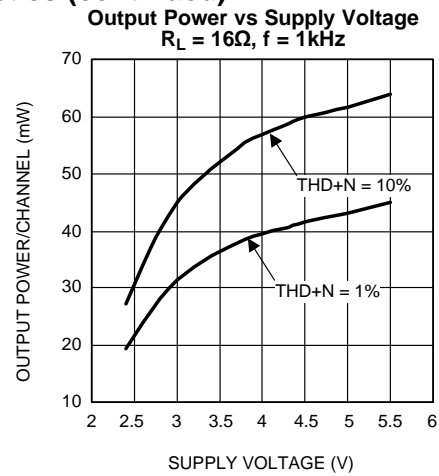

Figure 22.

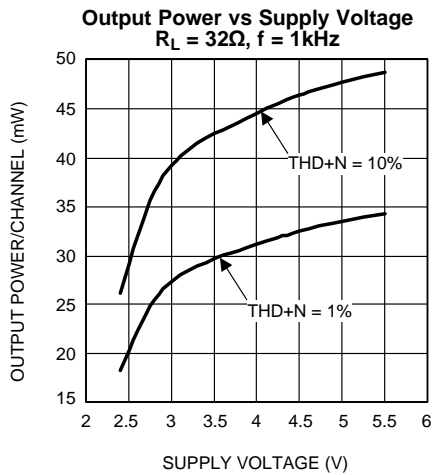

Figure 23.

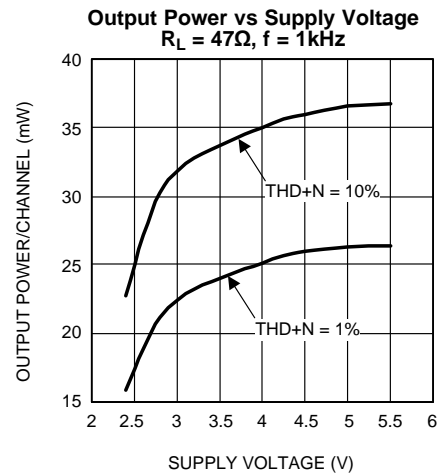

Figure 24.

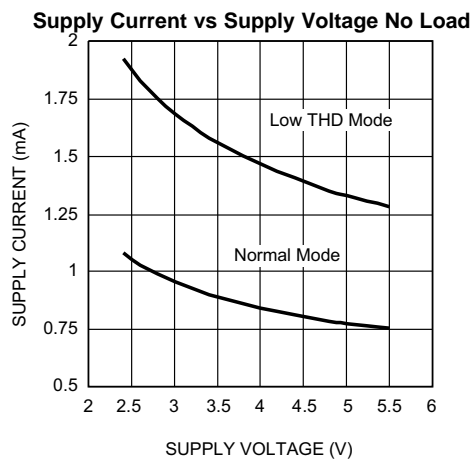

Figure 25.

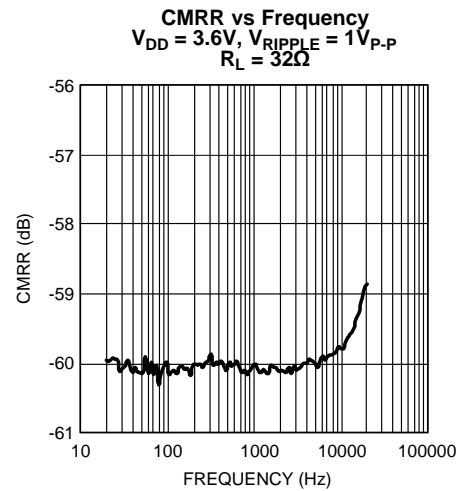

Figure 26.

Typical Performance Characteristics (continued)

PSRR vs Frequency
 $V_{DD} = 3.6V$, $V_{RIPPLE} = 200V_{P-P}$
 $R_L = 32\Omega$

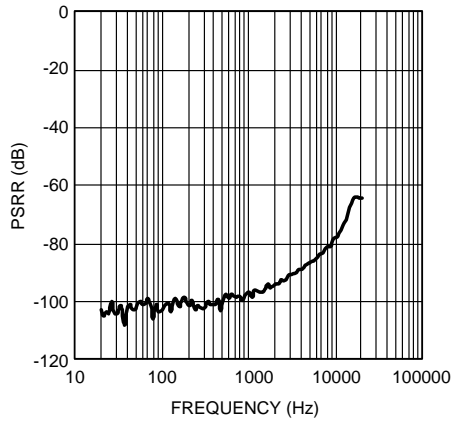

Figure 27.

Crosstalk vs Frequency
 $V_{DD} = 3.6V$, $P_O = 5mW$
 $R_L = 32\Omega$

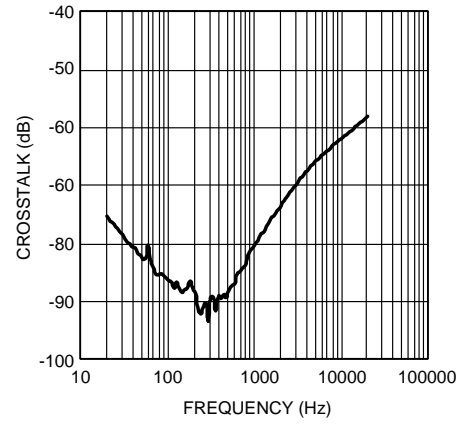

Figure 28.

APPLICATION INFORMATION

I²C COMPATIBLE INTERFACE

The LM48824 is controlled through an I²C compatible serial interface that consists of a serial data line (SDA) and a serial clock (SCL). The clock line is uni-directional. The data line is bi-directional (open drain). The LM48824 and the master can communicate at clock rates up to 400kHz. Figure 29 shows the I²C interface timing diagram. Data on the SDA line must be stable during the HIGH period of SCL. The LM48824 is a transmit/receive slave-only device, reliant upon the master to generate the SCL signal. Each transmission sequence is framed by a START condition and a STOP condition (Figure 30). Each data word, device address and data, transmitted over the bus is 8 bits long and is always followed by an acknowledge pulse (Figure 31). The LM48824 device address is 1100000.

I²C BUS FORMAT

The I²C bus format is shown in Figure 31. The START signal, the transition of SDA from HIGH to LOW while SCL is HIGH, is generated, alerting all devices on the bus that a device address is being written to the bus.

The 7-bit device address is written to the bus, most significant bit (MSB) first, followed by the $\overline{R/W}$ bit ($\overline{R/W} = 0$ indicates the master is writing to the LM48824, $\overline{R/W} = 1$ indicates the master wants to read data from the LM48824). Data is latched into the device on the rising clock edge. Each address bit must be stable while SCL is HIGH. After the last address bit is transmitted, the master device releases SDA, during which time, an acknowledge clock pulse is generated by the slave device. If the LM48824 receives the correct address, the device pulls the SDA line low, generating an acknowledge bit (ACK).

Once the master device registers the ACK bit, the 8-bit register address word is sent. Each data bit should be stable while SCL is HIGH. After the 8-bit register address is sent, the LM48824 sends another ACK bit. Following the acknowledgment of the register address, the 8-bit register data word is sent. Each data bit should be stable while SCL is HIGH. After the 8-bit register data is sent, the LM48824 sends another ACK bit. Following the acknowledgement of the register data word, the master issues a STOP bit, allowing SDA to go high while SCL is high.

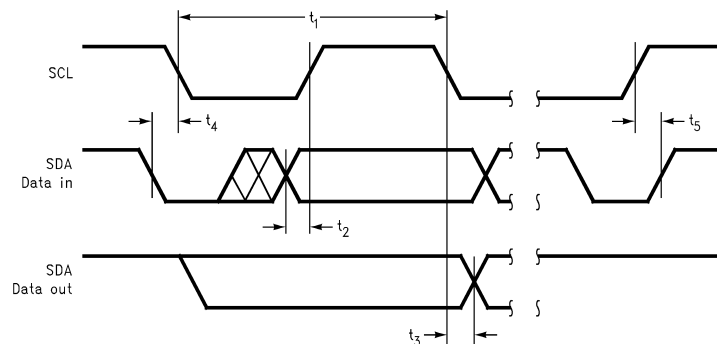

Figure 29. I²C Timing Diagram

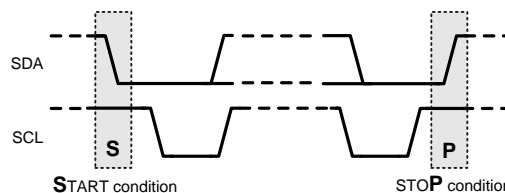

Figure 30. Start and Stop Diagram

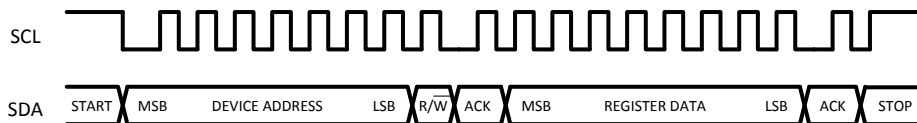

Figure 31. I²C Write Cycle

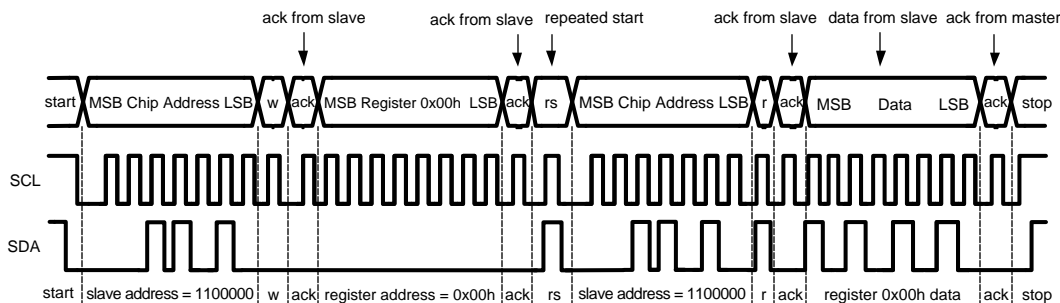

Figure 32. Example I²C Read Cycle

Table 1. Device Address

	B7	B6	B5	B4	B3	B2	B1	B0 (R/W)
Device Address	1	1	0	0	0	0	0	X

Table 2. I²C Control Registers⁽¹⁾

Register Address	Register Name	B7	B6	B5	B4	B3	B2	B1	B0
0x01h	MODE CONTROL	HPL_EN	HPR_EN	0	0	0	0	THRM	SHDN
0x02h	VOLUME CONTROL	MUTE_L	MUTE_R	VOL4	VOL3	VOL2	VOL1	VOL0	0
0x03h	OUTPUT CONTROL	0	0	0	0	LOW_THD	0	HiZ_L	HiZ_R
0x04h	DEVICE INFORMATION (Read-Only)	0	1	0	0	0	0	0	0

(1) All registers default to 0 on initial power-up except SHDN, MUTE_L, MUTE_R bits default to 1 at power-up.

Table 3. Mode Control Register

Bit	Name	Value	Description
B0	SHDN	0	Device enabled
		1	Device disabled
B1	THRM (Read Only)	0	Thermal-protection inactive
		1	Thermal-protection active
B6	HPR_EN	0	Right channel amplifier disabled
		1	Right channel amplifier enabled
B7	HPL_EN	0	Left channel amplifier disabled
		1	Left channel amplifier enabled

Table 4. Volume Control Register

Bit	Name	Value	Description
B5:B1	VOL4:VOL0		These bits set the volume level. See Table 5 .
B6	MUTE_R	0	Right Channel Mute Disabled
		1	Right Channel Mute Enabled
B7	MUTE_L	0	Left Channel Mute Disabled
		1	Left Channel Mute Enabled

Table 5. Volume Control

Volume Step	VOL4	VOL3	VOL2	VOL1	VOL0	HP Gain (dB)
0	0	0	0	0	0	-59
1	0	0	0	0	1	-55
2	0	0	0	1	0	-51
3	0	0	0	1	1	-47
4	0	0	1	0	0	-43
5	0	0	1	0	1	-39
6	0	0	1	1	0	-35
7	0	0	1	1	1	-31
8	0	1	0	0	0	-27
9	0	1	0	0	1	-25
10	0	1	0	1	0	-23
11	0	1	0	1	1	-21
12	0	1	1	0	0	-19
13	0	1	1	0	1	-17
14	0	1	1	1	0	-15
15	0	1	1	1	1	-13
16	1	0	0	0	0	-11
17	1	0	0	0	1	-10
18	1	0	0	1	0	-9
19	1	0	0	1	1	-8
20	1	0	1	0	0	-7
21	1	0	1	0	1	-6
22	1	0	1	1	0	-5
23	1	0	1	1	1	-4
24	1	1	0	0	0	-3
25	1	1	0	0	1	-2
26	1	1	0	1	0	-1
27	1	1	0	1	1	0
28	1	1	1	0	0	1
29	1	1	1	0	1	2
30	1	1	1	1	0	3
31	1	1	1	1	1	4

Table 6. Output Control Register

Bit	Name	Value	Description
B0	HiZ_R	0	Right channel high impedance mode disabled
		1	Right channel high impedance mode enabled
B1	HiZ_L	0	Left channel high impedance mode disabled
		1	Left channel high impedance mode enabled
B3	LOW_THD	0	LOW_THD mode disabled
		1	LOW_THD mode enabled, improves overall THD

GENERAL DEVICE FUNCTION

The LM48824 integrates a high efficiency step down (buck) DC-DC switching regulator with a ground reference headphone amplifier. The switching regulator delivers a constant voltage from an input voltage ranging from 2.4V to 5.5V. The switching regulator uses a voltage-mode architecture with synchronous rectification, improving efficiency and reducing component count.

The LM48824 headphone amplifier features TI's ground referenced architecture that eliminates the large DC-blocking capacitors required at the outputs of traditional single-ended headphone amplifiers. A low-noise inverting charge pump creates a negative supply (HPV_{SS}) from the positive supply voltage (V_{DD}). The headphone amplifiers operate from these bipolar supplies, with the amplifier outputs biased about GND. Because there is no DC component on the output signals, the large DC-blocking, AC coupling capacitors (typically 220µF) are not necessary, conserving board space, reducing system cost, and improving frequency response.

CLASS G OPERATION

Class G is a modification of some other class of amplifier (normally Class B or Class AB) to increase efficiency and reduce power dissipation. Class G works off the fact that musical and voice signals have a high peak to mean ratio with most of the signal content at low levels. To decrease power dissipation, Class G has multiple voltage supplies. The LM48824 has two discrete voltage supplies at the output of the buck, 1.1V and 1.8V. When the output reached the threshold to switch to the higher voltage rails, the rails will switch from 1.1V to 1.8V. When the output falls below the required voltage rails for a set period of time, it will switch back to the lower rail until the next time the threshold is reached. Power dissipation is greatly reduced for typical musical or voice sources. The drawing below shows how a musical output may look. The green lines are the supply voltages at the output of the buck converter.

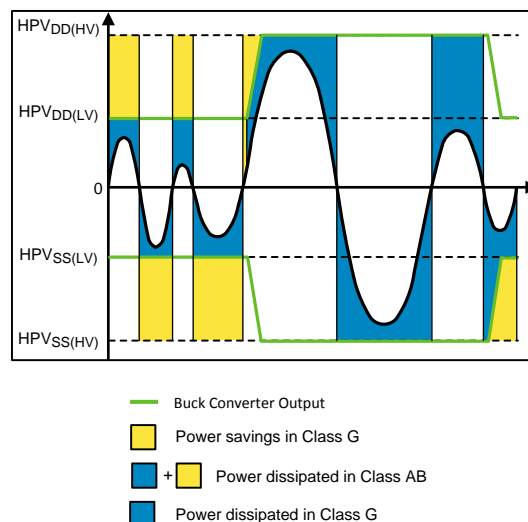

Figure 33. Class G Operation

DIFFERENTIAL AMPLIFIER EXPLANATION

The LM48824 features a differential input stage, which offers improved noise rejection compared to a single-ended input amplifier. Because a differential input amplifier amplifies the difference between the two input signals, any component common to both signals is cancelled.

SYNCHRONOUS RECTIFIER

The buck converter in the LM48824 uses an internal NFET synchronous rectifier to reduce rectifier forward voltage drop and associated power loss. Synchronous rectification provides a significant improvement in efficiency whenever the output voltage is relative low compared to the voltage drop across an ordinary rectifier diode and eliminating the need for the diode.

CURRENT LIMITING

A current limit of the buck converter in the LM48824 allows the device to protect itself and external components during overload conditions.

PFM OPERATION

During PFM(Pulse-Frequency Modulation) operation, if the output voltage of the buck converter is below the 'high' PFM comparator threshold, the PMOS power switch is turned on. It remains on until the output voltage reaches the 'high' PFM threshold or the peak current exceeds the I_{PFM} level set for PFM mode. The typical peak current in PFM mode is $I_{PFM} = 112\text{mA} + V_{DD}/27\Omega$.

Once the PMOS power switch is turned off, the NMOS power switch is turned on until the inductor current ramps to zero. When the NMOS zero-current condition is detected, the NMOS power switch is turned off. If the output voltage is below the 'high' PFM comparator threshold, the PMOS switch is again turned on and the cycle is repeated until the output reaches the desired level. Once the output reaches the 'high' PFM threshold, the NMOS switch is turned on briefly to ramp the inductor current to zero and then both output switches are turned off and the part enters an extremely low power mode.

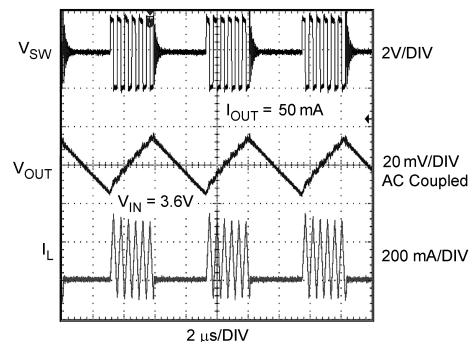

Figure 34. PFM Operation

SOFT START

The buck converter has a soft-start circuit that limits in-rush current during start-up. During start-up the switch current limit is increased in steps. Soft start is activated only if global SHDN goes from 1 to 0 after V_{DD} reaches 2.7V. Soft start is implemented by increasing switch current limit in steps of 70mA, 140mA, 280mA, and 750mA (typical switch current limit). The start-up time thereby depends on the output capacitor and load current of the buck converter. Typical start-up times with a 10 μF output capacitor and 150mA load is 280 μs and with 5mA load is 240 μs .

COMMON-MODE SENSE

The LM48824 features a ground (common mode) sensing feature. In noisy applications, or where the headphone jack is used as a line out to other devices, noise pick up and ground imbalance can degrade audio quality. The LM48824 COM input senses and corrects any noise at the headphone return, or any ground imbalance between the headphone return and device ground, improving audio reproduction. Connect COM directly to the headphone return terminal of the headphone jack (Figure 35). No additional external components are required. Connect COM to GND if the common-mode sense feature is not in use.

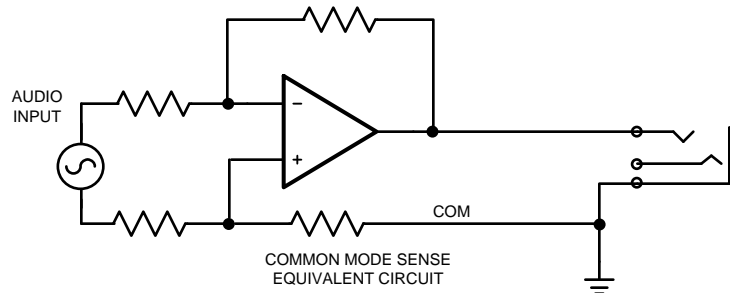

Figure 35. COM Connection

SHUTDOWN FUNCTION

The LM48824 features individual amplifier shutdown control and a global device shutdown control.

Bit B0 (SHDN) of the MODE CONTROL register controls the global shutdown for the entire device. Set SHDN = 1 to put the device into current-saving shutdown mode, and set SHDN = 0 for normal operation. SHDN defaults to 1 at power-up.

Bit B7 (HPL_EN) and Bit B6 (HPR_EN) of the MODE CONTROL register (register address 0x01h) controls the left and right headphone amplifier shutdown respectively. Set HPL_EN = 0 to set the left channel headphone amplifier to shutdown and set HPL_EN = 1 to enable left channel operation. Set HPR_EN = 0 to set the right channel headphone amplifier to shutdown and set HPR_EN = 1 to enable right channel operation. The left and right channel amplifier shutdowns operate individually.

The LM48824 has a shutdown time of 3ms to complete the internal shutdown sequence. After SHDN is set to 1, any new I²C commands should only be sent after the 3ms shutdown time to ensure proper operation of the device.

MUTE FUNCTION

The LM48824 features independent left and right channel mute functions.

Bit B7 (MUTE_L) and Bit B6 (MUTE_R) of the VOLUME CONTROL register (register address 0x02h) controls the mute function of the left and right channels respectively. Set MUTE_L = 1 to mute the left channel and set the MUTE_R = 1 to mute the right channel. Set MUTE_L = 0 and MUTE_R = 0 to disable mute on the respective channels. MUTE_L and MUTE_R defaults to 1 at power-up.

LOW THD+N MODE

The LM48824 features a Low THD mode that reduces THD+N to improve audio quality. Set B3 (Low_THD) of the OUTPUT CONTROL register (register address 0x03h) to 1 to enable the Low THD mode. There is a quiescent and operating current increase in Low THD mode. See [Electrical Characteristics](#) and [Typical Performance Characteristics](#) for reference.

PROPER SELECTION OF EXTERNAL COMPONENTS

INDUCTOR SELECTION

There are two main considerations when choosing an inductor; the inductor saturation current and the inductor current ripple should be small enough to achieve the desired output voltage ripple. Different saturation current rating specifications are followed by different manufacturers so attention must be given to details. Saturation current ratings are typically specified at 25°C, ratings at the maximum ambient temperature of application should be requested from the manufacturer. Shielded capacitors are preferred since these capacitors radiate less noise. Inductors with low DCR should also be considered to minimize the efficiency.

Inductor value involves trade-offs in performance. Larger inductors reduce inductor triple current, which typically means less output voltage ripple (for a given size of output capacitor).

REGULATOR INPUT CAPACITOR SELECTION (C3)

A ceramic input capacitor of 1µF, 6.3V is sufficient for most applications. Place the input capacitor as close as possible to the V_{DD} pin of the device. A larger value may be used for improved input voltage filtering. Use X7R or X5R types; do not use Y5V. DC bias characteristics of ceramic capacitors must be considered when selecting case sizes like 0805 and 0603.

REGULATOR OUTPUT CAPACITOR SELECTION (C4)

A low ESR ceramic output capacitor of 10µF, 6.3V is sufficient for most applications. Use X7R or X5R types; do not use Y5V. DC bias characteristics of ceramic capacitors must be considered when selecting case sizes like 0805 and 0603. DC bias characteristics vary from manufacturer to manufacturer and dc bias curves should be requested from them as part of the capacitor selection process.

CHARGE PUMP CAPACITOR SELECTION

Use low ESR ceramic capacitors (less than 100mΩ) for optimum performance.

CHARGE PUMP FLYING CAPACITOR (C1)

The flying capacitor (C1) affects the load regulation and output impedance of the charge pump. A C1 value that is too low results in a loss of current drive, leading to a loss of amplifier headroom. A higher valued C1 improves load regulation and lowers charge pump output impedance to an extent. Above 2.2µF, the R_{DS(ON)} of the charge pump switches and the ESR of C1 and C2 dominate the output impedance. A lower value capacitor can be used in systems with low maximum output power requirements.

CHARGE PUMP HOLD CAPACITOR (C2)

The value and ESR of the hold capacitor (C2) directly affects the ripple on CPV_{SS}. Increasing the value of C2 reduces output ripple. Decreasing the ESR of C2 reduces both output ripple and charge pump output impedance. A lower value capacitor can be used in systems with low maximum output power requirements.

Amplifier Input Capacitor Selection

Input capacitors may be required for some applications, or when the audio source is single-ended. Input capacitors block the DC component of the audio signal, eliminating any conflict between the DC component of the audio source and the bias voltage of the LM48824. The input capacitors create a high-pass filter with the input resistors R_{IN}. The -3dB point of the high-pass filter is found using the equation below.

$$f = 1 / 2\pi R_{IN} C_{IN} \quad (\text{Hz}) \quad (1)$$

Where the value of R_{IN} is given in the [Electrical Characteristics VDD = 3.6V](#).

High-pass filtering the audio signal can be beneficial for some applications. When the LM48824 is using a single-ended source, power supply noise on the ground is seen as an input signal. Setting the high-pass filter point above the power supply noise frequencies, 217Hz in a GSM phone, for example, filters out the noise such that it is not amplified and heard on the output. Capacitors with a tolerance of 10% or better are recommended for impedance matching and improved CMRR and PSRR.

SINGLE-ENDED AUDIO AMPLIFIER CONFIGURATION

The LM48824 is compatible with single-ended sources. Figure 36 shows the typical single-ended applications circuit. Input coupling capacitors are required for single-ended configuration.

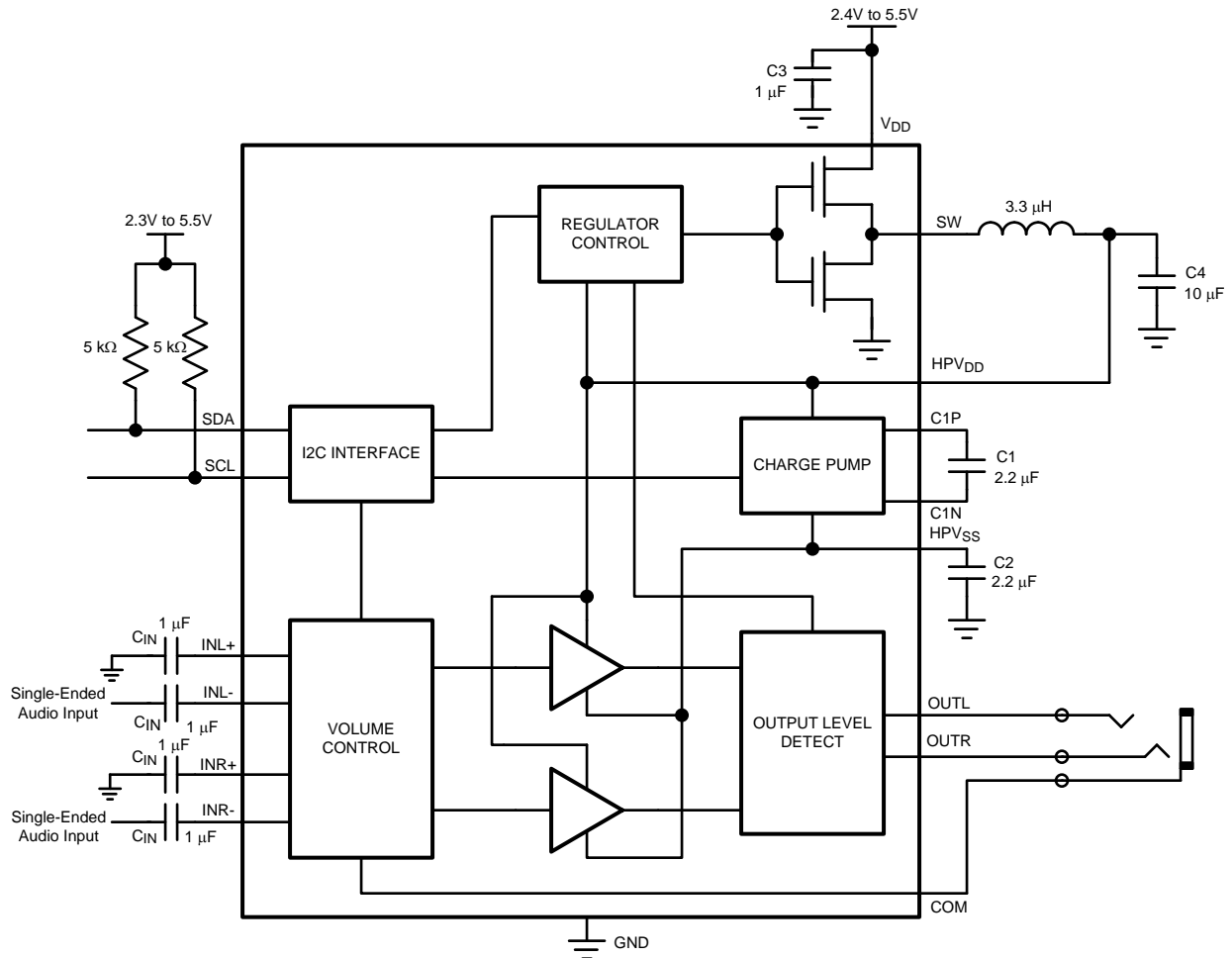

Figure 36. Single-Ended Input Configuration

PCB LAYOUT CONFIGURATION

Table 7. LM48824TM Demoboard Bill of Materials

Designator	Quantity	Description
C1	1	10µF ±10% 16V 500Ω Tantalum Capacitor (B Case) AVX TPSB106K016R0500
C2	1	1µF ±10% 16V X5R Ceramic Capacitor (603) Panasonic ECJ-1VB1C105K
C3, C8, C9	3	2.2µF ±10% 10V X5R Ceramic Capacitor (603) Panasonic ECJ-1VB1A225K
C4 – C7	4	1µF ±10% 16V X7R Ceramic Capacitor (1206) Panasonic ECJ-3YB1C105K
R1, R2	2	5kΩ ±5% 1/10W Thick Film Resistor (603) Vishay CRCW06035R1KJNEA
L1	1	3.3µH ± 30% 1.2A Inductor Murata LQM2MPN3R3NG0L
J1	1	Stereo Headphone Jack
J2	1	16-Pin Boardmount Socket 3M 8516-4500JL
JU1	1	3 Pin Header
JU2	1	2 Pin Header
LM4822TM	1	LM48824TM (16-Bump microSMD)

Demoboard Schematic

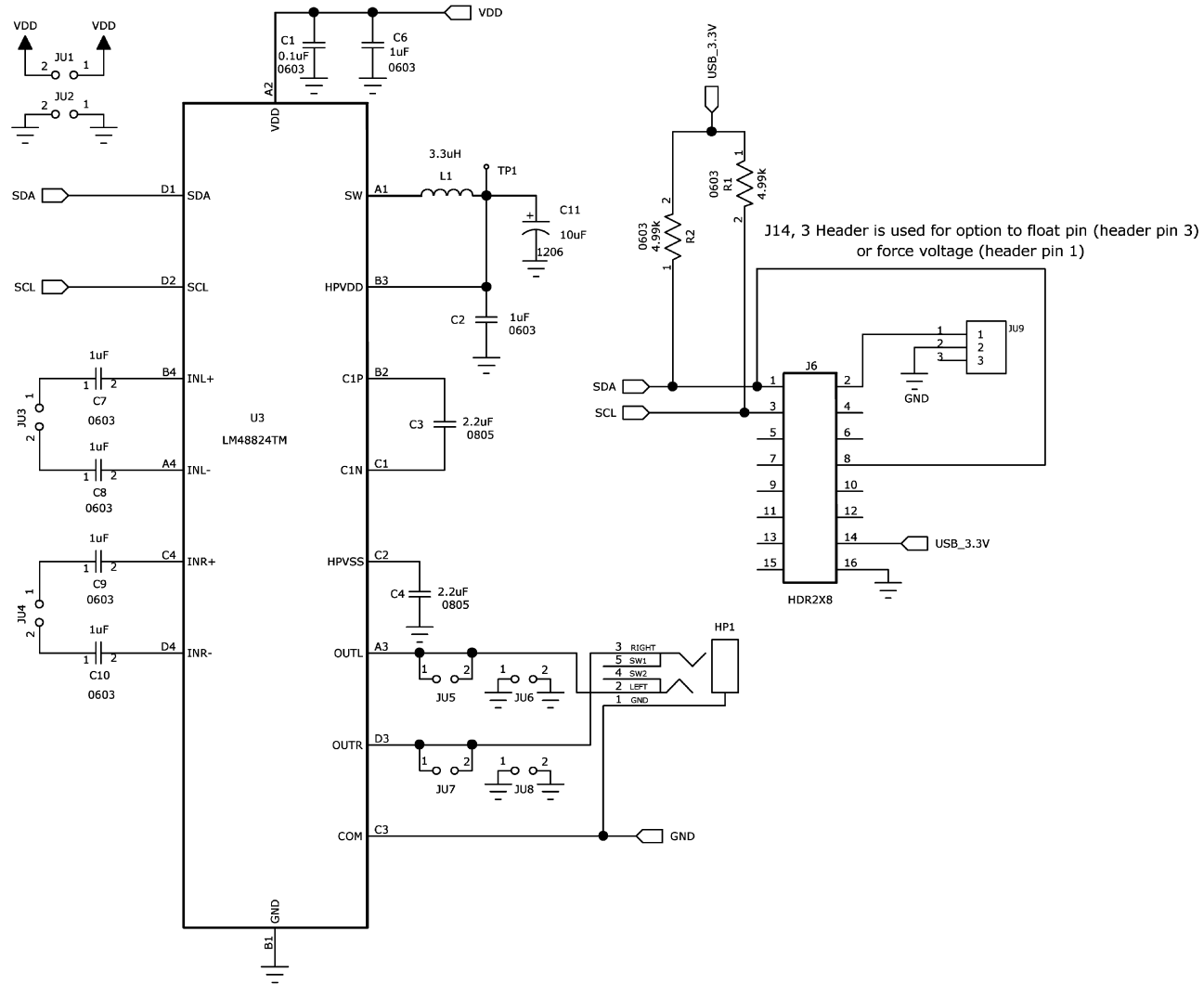

Figure 37. LM48824 Demoboard Schematic

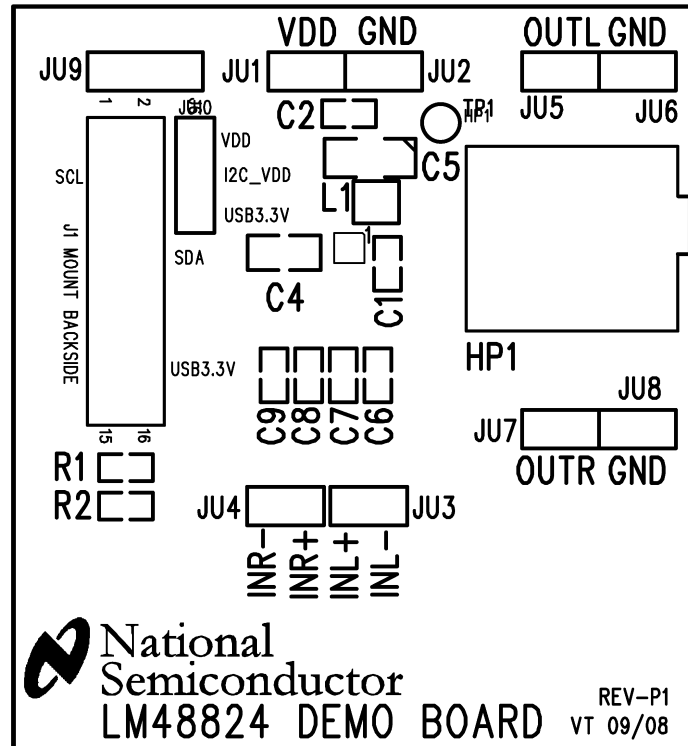

Figure 38. Top Silkscreen

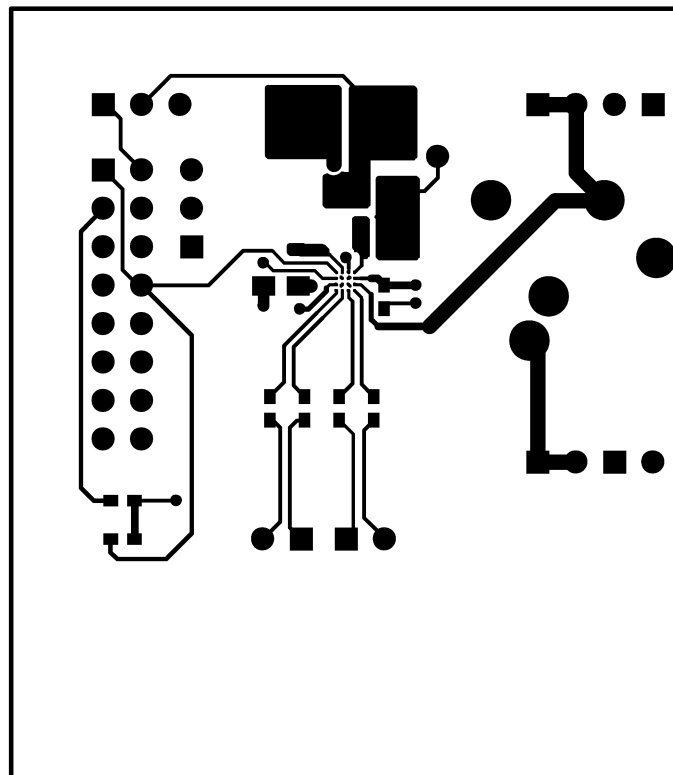

Figure 39. Top Layer

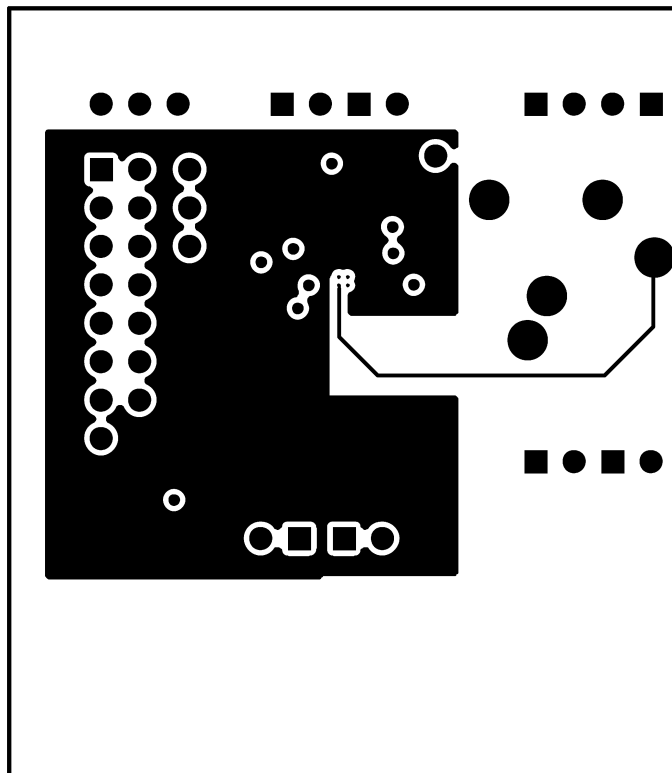

Figure 40. Layer 2 (GND)

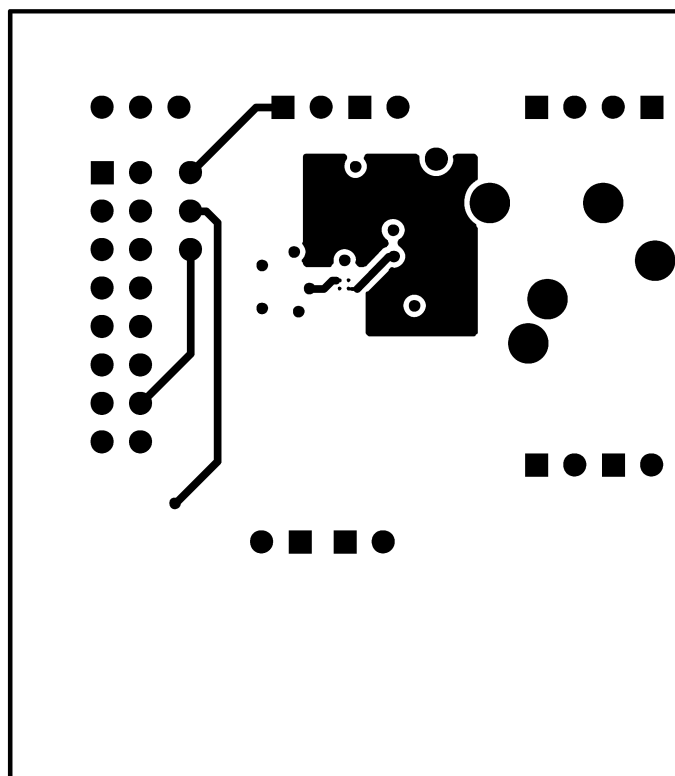

Figure 41. Layer 3 (VDD)

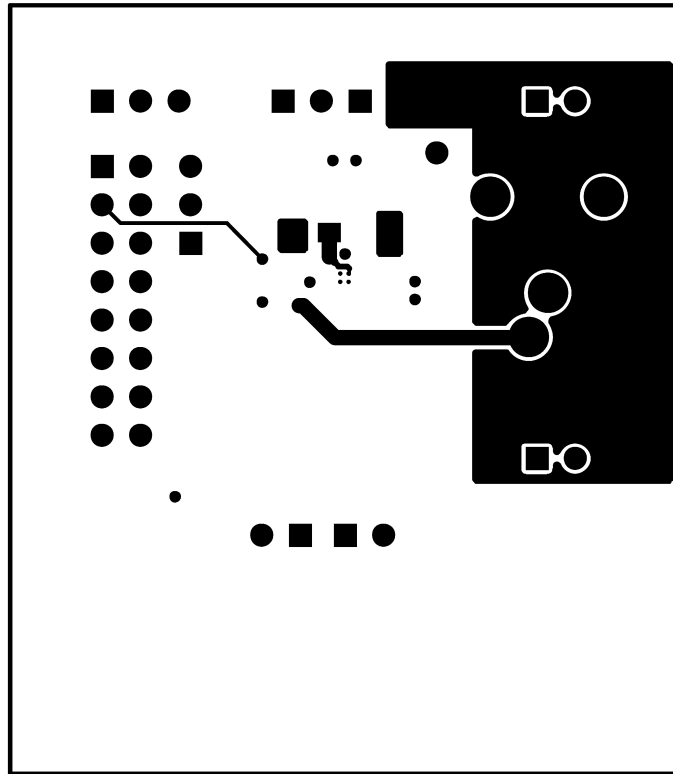

Figure 42. Bottom Layer

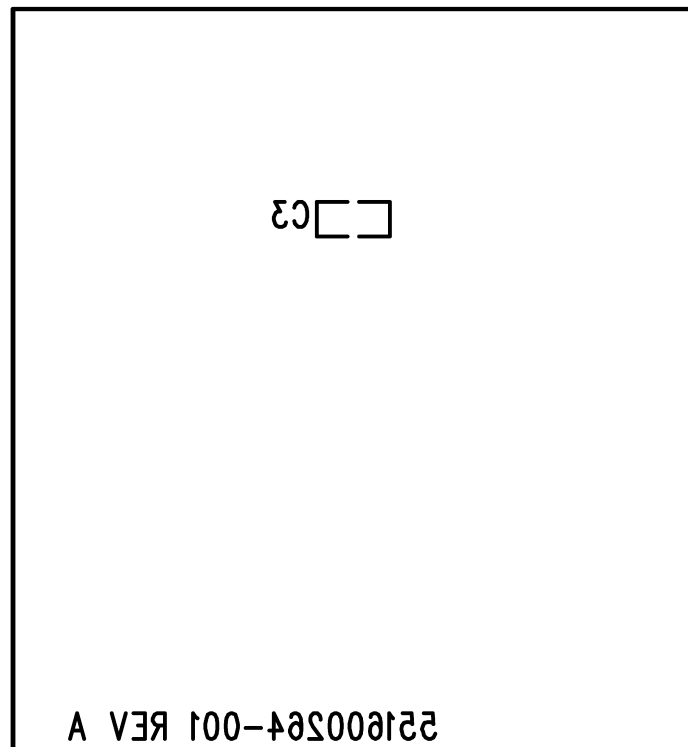



Figure 43. Bottom Silkscreen

Revision History

Rev	Date	Description
1.0	08/06/09	Initial released of the full datasheet.
1.01	08/31/09	Text edits.
D	05/02/2013	Changed layout of National Data Sheet to TI format.

PACKAGING INFORMATION

Orderable Device	Status (1)	Package Type	Package Drawing	Pins	Package Qty	Eco Plan (2)	Lead finish/ Ball material (6)	MSL Peak Temp (3)	Op Temp (°C)	Device Marking (4/5)	Samples
LM48824TM/NOPB	ACTIVE	DSBGA	YFQ	16	250	RoHS & Green	SNAGCU	Level-1-260C-UNLIM	-40 to 85	GL6	
LM48824TMX/NOPB	ACTIVE	DSBGA	YFQ	16	3000	RoHS & Green	SNAGCU	Level-1-260C-UNLIM	-40 to 85	GL6	

(1) The marketing status values are defined as follows:

ACTIVE: Product device recommended for new designs.

LIFEBUY: TI has announced that the device will be discontinued, and a lifetime-buy period is in effect.

NRND: Not recommended for new designs. Device is in production to support existing customers, but TI does not recommend using this part in a new design.

PREVIEW: Device has been announced but is not in production. Samples may or may not be available.

OBSELETE: TI has discontinued the production of the device.

(2) **RoHS:** TI defines "RoHS" to mean semiconductor products that are compliant with the current EU RoHS requirements for all 10 RoHS substances, including the requirement that RoHS substance do not exceed 0.1% by weight in homogeneous materials. Where designed to be soldered at high temperatures, "RoHS" products are suitable for use in specified lead-free processes. TI may reference these types of products as "Pb-Free".

RoHS Exempt: TI defines "RoHS Exempt" to mean products that contain lead but are compliant with EU RoHS pursuant to a specific EU RoHS exemption.

Green: TI defines "Green" to mean the content of Chlorine (Cl) and Bromine (Br) based flame retardants meet JS709B low halogen requirements of <=1000ppm threshold. Antimony trioxide based flame retardants must also meet the <=1000ppm threshold requirement.

(3) MSL, Peak Temp. - The Moisture Sensitivity Level rating according to the JEDEC industry standard classifications, and peak solder temperature.

(4) There may be additional marking, which relates to the logo, the lot trace code information, or the environmental category on the device.

(5) Multiple Device Markings will be inside parentheses. Only one Device Marking contained in parentheses and separated by a "-" will appear on a device. If a line is indented then it is a continuation of the previous line and the two combined represent the entire Device Marking for that device.

(6) Lead finish/Ball material - Orderable Devices may have multiple material finish options. Finish options are separated by a vertical ruled line. Lead finish/Ball material values may wrap to two lines if the finish value exceeds the maximum column width.

Important Information and Disclaimer:The information provided on this page represents TI's knowledge and belief as of the date that it is provided. TI bases its knowledge and belief on information provided by third parties, and makes no representation or warranty as to the accuracy of such information. Efforts are underway to better integrate information from third parties. TI has taken and continues to take reasonable steps to provide representative and accurate information but may not have conducted destructive testing or chemical analysis on incoming materials and chemicals. TI and TI suppliers consider certain information to be proprietary, and thus CAS numbers and other limited information may not be available for release.

In no event shall TI's liability arising out of such information exceed the total purchase price of the TI part(s) at issue in this document sold by TI to Customer on an annual basis.

TAPE AND REEL INFORMATION

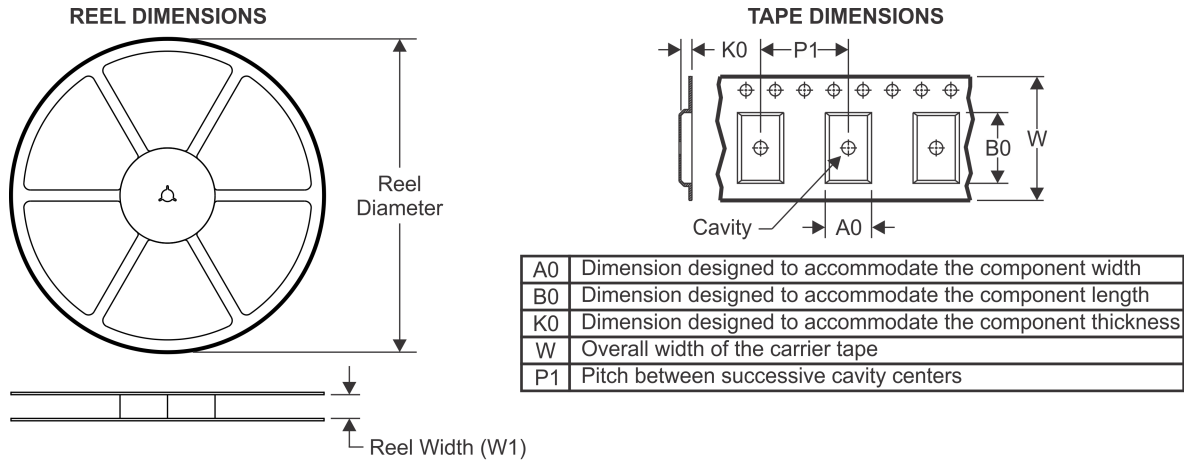

QUADRANT ASSIGNMENTS FOR PIN 1 ORIENTATION IN TAPE



*All dimensions are nominal

Device	Package Type	Package Drawing	Pins	SPQ	Reel Diameter (mm)	Reel Width W1 (mm)	A0 (mm)	B0 (mm)	K0 (mm)	P1 (mm)	W (mm)	Pin1 Quadrant
LM48824TM/NOPB	DSBGA	YFQ	16	250	178.0	8.4	1.85	2.01	0.76	4.0	8.0	Q1
LM48824TMX/NOPB	DSBGA	YFQ	16	3000	178.0	8.4	1.85	2.01	0.76	4.0	8.0	Q1

TAPE AND REEL BOX DIMENSIONS

*All dimensions are nominal

Device	Package Type	Package Drawing	Pins	SPQ	Length (mm)	Width (mm)	Height (mm)
LM48824TM/NOPB	DSBGA	YFQ	16	250	210.0	185.0	35.0
LM48824TMX/NOPB	DSBGA	YFQ	16	3000	210.0	185.0	35.0

YFQ0016

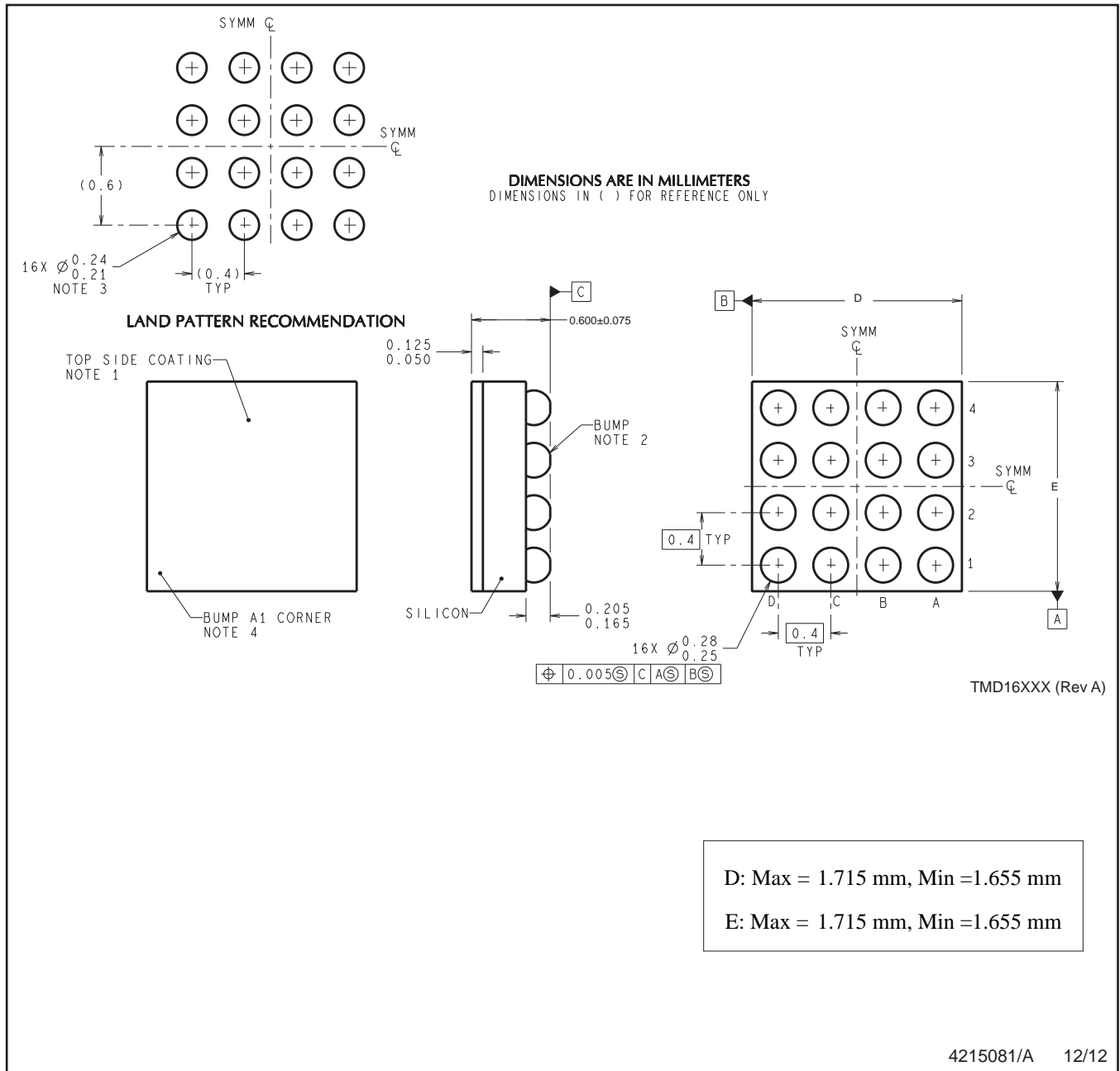

NOTES: A. All linear dimensions are in millimeters. Dimensioning and tolerancing per ASME Y14.5M-1994.
B. This drawing is subject to change without notice.

IMPORTANT NOTICE AND DISCLAIMER

TI PROVIDES TECHNICAL AND RELIABILITY DATA (INCLUDING DATASHEETS), DESIGN RESOURCES (INCLUDING REFERENCE DESIGNS), APPLICATION OR OTHER DESIGN ADVICE, WEB TOOLS, SAFETY INFORMATION, AND OTHER RESOURCES "AS IS" AND WITH ALL FAULTS, AND DISCLAIMS ALL WARRANTIES, EXPRESS AND IMPLIED, INCLUDING WITHOUT LIMITATION ANY IMPLIED WARRANTIES OF MERCHANTABILITY, FITNESS FOR A PARTICULAR PURPOSE OR NON-INFRINGEMENT OF THIRD PARTY INTELLECTUAL PROPERTY RIGHTS.

These resources are intended for skilled developers designing with TI products. You are solely responsible for (1) selecting the appropriate TI products for your application, (2) designing, validating and testing your application, and (3) ensuring your application meets applicable standards, and any other safety, security, or other requirements. These resources are subject to change without notice. TI grants you permission to use these resources only for development of an application that uses the TI products described in the resource. Other reproduction and display of these resources is prohibited. No license is granted to any other TI intellectual property right or to any third party intellectual property right. TI disclaims responsibility for, and you will fully indemnify TI and its representatives against, any claims, damages, costs, losses, and liabilities arising out of your use of these resources.

TI's products are provided subject to TI's Terms of Sale (<https://www.ti.com/legal/termsofsale.html>) or other applicable terms available either on [ti.com](https://www.ti.com) or provided in conjunction with such TI products. TI's provision of these resources does not expand or otherwise alter TI's applicable warranties or warranty disclaimers for TI products.

Mailing Address: Texas Instruments, Post Office Box 655303, Dallas, Texas 75265
Copyright © 2021, Texas Instruments Incorporated