

Features

- 0.8 INCH DIGIT HEIGHT.
- LOW CURRENT OPERATION.
- EXCELLENT CHARACTER APPEARANCE.
- EASY MOUNTING ON P.C. BOARDS OR SOCKETS.
- I.C. COMPATIBLE.
- CATEGORIZED FOR LUMINOUS INTENSITY.
- MECHANICALLY RUGGED.
- STANDARD : GRAY FACE, WHITE SEGMENT.
- RoHS COMPLIANT.

Description

The Super Bright Red source color devices are made with Gallium Aluminum Arsenide Red Light Emitting Diode.

Package Dimensions& Internal Circuit Diagram

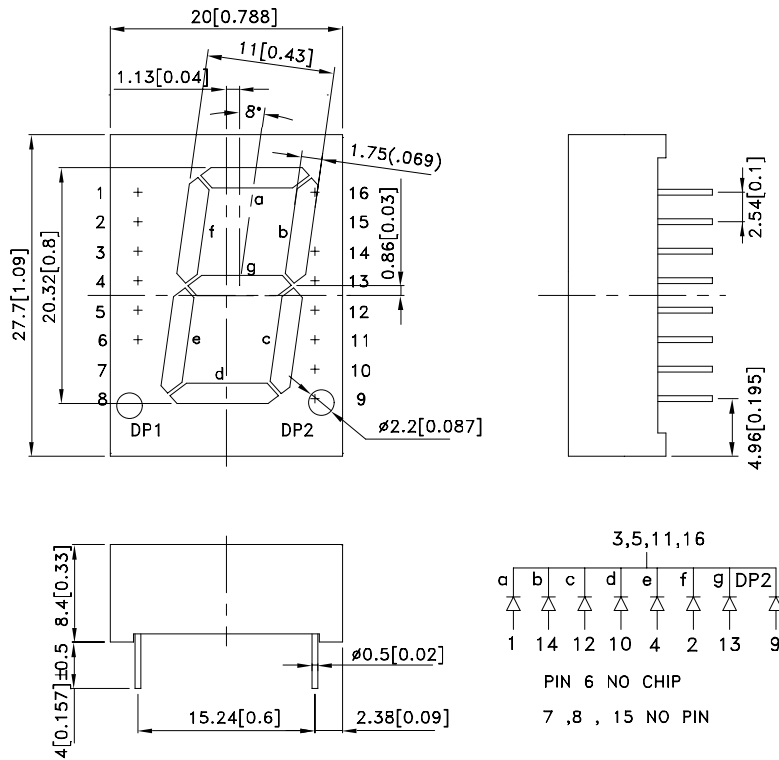

Notes:

1. All dimensions are in millimeters (inches), Tolerance is $\pm 0.25(0.01)$ unless otherwise noted.
2. Specifications are subject to change without notice.



Selection Guide

Part No.	Dice	Lens Type	Iv (ucd) [1] @ 10mA		Description
			Min.	Typ.	
SC08-11SRWA	Super Bright Red (GaAlAs)	WHITE DIFFUSED	8000	36000	Common Cathode, Rt. Hand Decimal

Note:

1. Luminous intensity/ luminous Flux: +/-15%.

Electrical / Optical Characteristics at TA=25°C

Symbol	Parameter	Device	Typ.	Max.	Units	Test Conditions
λ_{peak}	Peak Wavelength	Super Bright Red	660		nm	I _F =20mA
λ_D [1]	Dominant Wavelength	Super Bright Red	640		nm	I _F =20mA
$\Delta\lambda_{1/2}$	Spectral Line Half-width	Super Bright Red	20		nm	I _F =20mA
C	Capacitance	Super Bright Red	45		pF	V _F =0V;f=1MHz
V _F [2]	Forward Voltage	Super Bright Red	1.85	2.5	V	I _F =20mA
I _R	Reverse Current	Super Bright Red		10	uA	V _R =5V

Notes:

- 1.Wavelength: +/-1nm.
2. Forward Voltage: +/-0.1V.

Absolute Maximum Ratings at TA=25°C

Parameter	Super Bright Red	Units
Power dissipation	75	mW
DC Forward Current	30	mA
Peak Forward Current [1]	155	mA
Reverse Voltage	5	V
Operating / Storage Temperature	-40°C To +85°C	
Lead Solder Temperature[2]	260°C For 3-5 Seconds	

Notes:

1. 1/10 Duty Cycle, 0.1ms Pulse Width.
2. 2mm below package base.

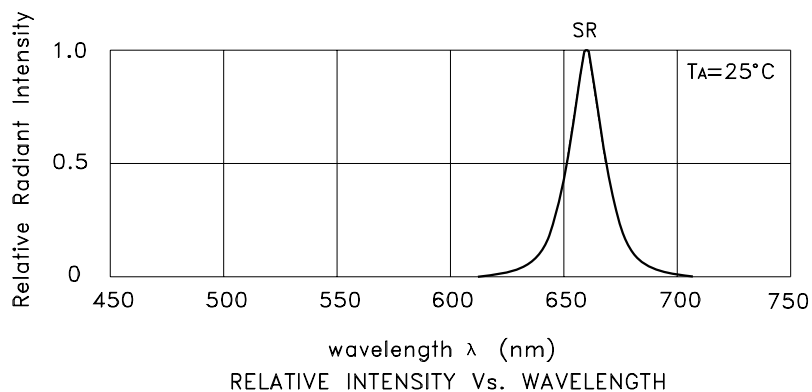

Super Bright Red SC08-11SRWA

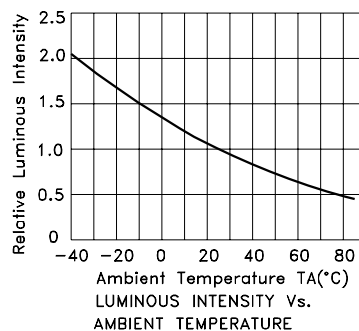
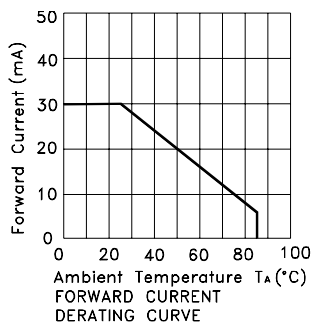
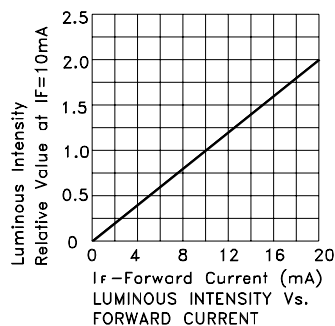
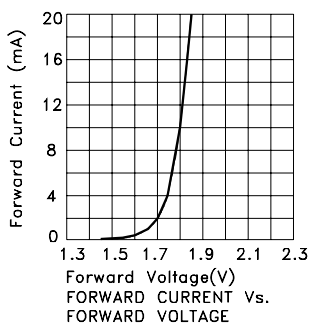

PACKING & LABEL SPECIFICATIONS

SC08-11SRWA

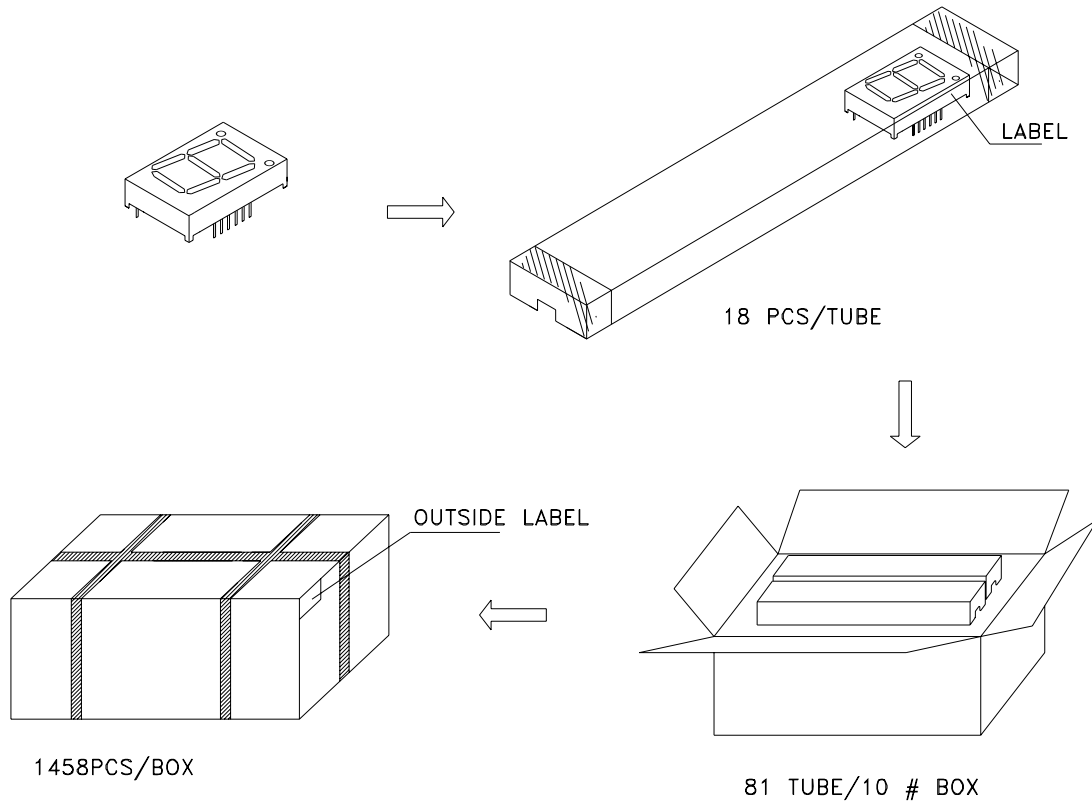

Inside LABEL Paste On The IC-tube

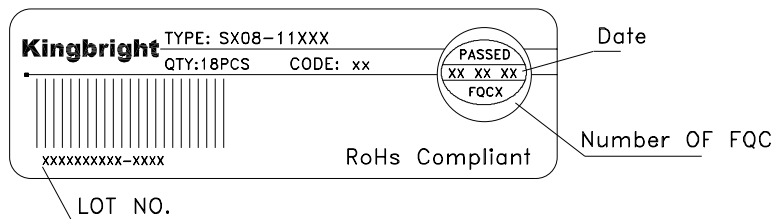

Outside LABEL Paste On The Box

