

# NBC-MR/ 2,0-94B/R4AC SCO US - Network cable



1406112

<https://www.phoenixcontact.com/us/products/1406112>

Please be informed that the data shown in this PDF document is generated from our online catalog. Please find the complete data in the user documentation. Our general terms of use for downloads are valid.



Network cable, Ethernet CAT5 (1 Gbps), 8-position, PUR halogen-free, water blue RAL 5021, shielded (Aluminum-coated foil, tinned copper braided shield), Plug angled M12, coding: A / IP67, on Plug straight RJ45 / IP20, cable length: 2 m

## Commercial data

Item number	1406112
Packing unit	1 pc
Minimum order quantity	1 pc
Note	Made to order (non-returnable)
Sales key	BF15
Product key	BF1IHB
GTIN	4046356799379
Weight per piece (including packing)	115.1 g
Weight per piece (excluding packing)	115.1 g
Customs tariff number	85444290
Country of origin	US

1406112

<https://www.phoenixcontact.com/us/products/1406112>

## Technical data

### Product properties

Product type	Data cable preassembled
Application	Standard, U.S. cables
Sensor type	Ethernet
Number of positions	8
Shielded	yes
Coding	A

### Interfaces

Bus system	Ethernet
Signal type/category	Ethernet CAT5 (based on IEC 11801), 1 Gbps

### Signaling

Status display	No
Status display present	No

### Electrical properties

Nominal voltage $U_N$	48 V AC
	60 V DC
Nominal current $I_N$	1 A
Transmission medium	Copper
Transmission characteristics (category)	CAT5 (IEC 11801:2002)

### Connector

#### Connection 1

Type	Plug angled M12 / IP67
Coding type	A (Standard)
Material	CuSn (Contact)
	Ni/Au (Contact surface)
	PA (Contact carriers)
	TPU, hardly inflammable, self-extinguishing (Grip)
	Zinc die-cast, nickel-plated (Screw connection)
Degree of protection	IP67

#### Connection 2

Type	Plug straight RJ45 / IP20
Material	CuSn (Contact)
	Ni/Au (Contact surface)
	PA (Contact carriers)
	PA (Housing)
Degree of protection	IP20

# NBC-MR/ 2,0-94B/R4AC SCO US - Network cable



1406112

<https://www.phoenixcontact.com/us/products/1406112>

## Cable/line

Cable length	2 m
--------------	-----

### Ethernet flexible CAT5, 4-pair [94B]

Dimensional drawing	
Cable weight	47 kg/km
UL AWM Style	20963 (80°C/30 V)
Number of positions	8
Shielded	yes
Cable type	Ethernet flexible CAT5, 4-pair [94B]
Conductor structure	4x2xAWG26/7, SF/UTP
Signal runtime	5.3 ns/m
Conductor structure signal line	7x 0.16 mm
AWG signal line	26
Conductor cross section	4x 2x 0.14 mm <sup>2</sup>
Wire diameter incl. insulation	0.96 mm
External cable diameter	6.40 mm ±0.2 mm
Outer sheath, material	PUR
External sheath, color	water blue RAL 5021
Conductor material	Bare Cu litz wires
Material wire insulation	Foamed PE
Single wire, color	white/blue-blue, white/orange-orange, white/green-green, white/brown-brown
Thickness, outer sheath	1.05 mm
Twisted pairs	2 cores to the pair
Overall twist	4 pairs for core
Optical shield covering	70 %
Insulation resistance	≥ 5 GΩ*km
Coupling resistance	≤ 100.00 mΩ/m (at 10 MHz)
Loop resistance	≤ 290.00 Ω/km
Wave impedance	100 Ω ±5 Ω (at 100 MHz)
Cable capacity	48 nF/km (at 1 kHz)
Nominal voltage, cable	≤ 100 V
Test voltage Core/Core	700 V (50 Hz, 1 min.)
Test voltage Core/Shield	700.00 V (50 Hz, 1 min.)
Minimum bending radius, fixed installation	4 x D
Minimum bending radius, flexible installation	8 x D

# NBC-MR/ 2,0-94B/R4AC SCO US - Network cable



1406112

<https://www.phoenixcontact.com/us/products/1406112>

Smallest bending radius, fixed installation	26 mm
Smallest bending radius, movable installation	52 mm
Tensile strength	≤ 100 N
Near end crosstalk attenuation (NEXT)	71.3 dB (with 1 MHz)
	62.3 dB (at 4 MHz)
	56.3 dB (at 10 MHz)
	53.2 dB (at 16 MHz)
	51.8 dB (at 20 MHz)
	48.9 dB (at 31.25 MHz)
	44.4 dB (at 62.5 MHz)
	41.3 dB (at 100 MHz)
Power-summated near end crosstalk attenuation (PSNEXT)	62.3 dB (with 1 MHz)
	53.3 dB (at 4 MHz)
	47.3 dB (at 10 MHz)
	44.2 dB (at 16 MHz)
	42.8 dB (at 20 MHz)
	39.9 dB (at 31.25 MHz)
	35.4 dB (at 62.5 MHz)
	32.3 dB (at 100 MHz)
Return attenuation (RL)	23 dB (at 4 MHz)
	24.1 dB (at 8 MHz)
	25 dB (at 10 MHz)
	25 dB (at 16 MHz)
	25 dB (at 20 MHz)
	23.6 dB (at 31.25 MHz)
	21.5 dB (at 62.5 MHz)
	20.1 dB (at 100 MHz)
Shield attenuation	3.2 dB (with 1 MHz)
	6 dB (at 4 MHz)
	9.5 dB (at 10 MHz)
	12.1 dB (at 16 MHz)
	13.6 dB (at 20 MHz)
	17.1 dB (at 31.25 MHz)
	24.8 dB (at 62.5 MHz)
	32 dB (at 100 MHz)
Halogen-free	according to IEC 60754-1
Flame resistance	according to IEC 60332-1-2
Resistance to oil	in accordance with EN 60811-2-1
Ambient temperature (operation)	-40 °C ... 80 °C (cable, fixed installation)
	-20 °C ... 80 °C (Cable, flexible installation)
Ambient temperature (installation)	-20 °C ... 80 °C

## Environmental and real-life conditions

# NBC-MR/ 2,0-94B/R4AC SCO US - Network cable



1406112

<https://www.phoenixcontact.com/us/products/1406112>

## Ambient conditions

Degree of protection	IP65 (M12 connector)
	IP67 (M12 connector)
	IP20 (RJ45 connector)
	IP67/IP20
Ambient temperature (operation)	-25 °C ... 85 °C (M12 connector)
	-25 °C ... 60 °C (RJ45 connector)

## Standards and regulations

### M12

Standard designation	M12 connector
Standards/specifications	IEC 61076-2-101

1406112

<https://www.phoenixcontact.com/us/products/1406112>

## Drawings

### Schematic diagram

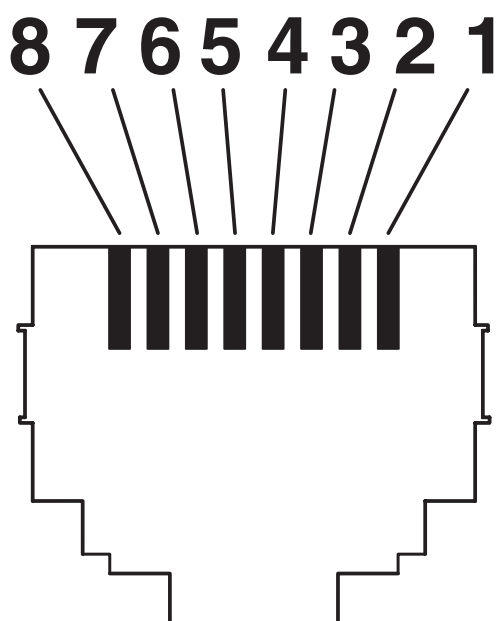

Connector pin assignment plug RJ45

1406112

<https://www.phoenixcontact.com/us/products/1406112>

Dimensional drawing

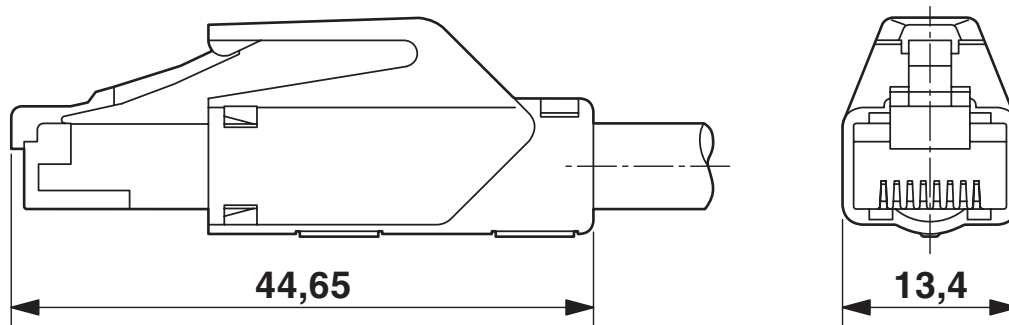

RJ45 connector, IP20

Schematic diagram

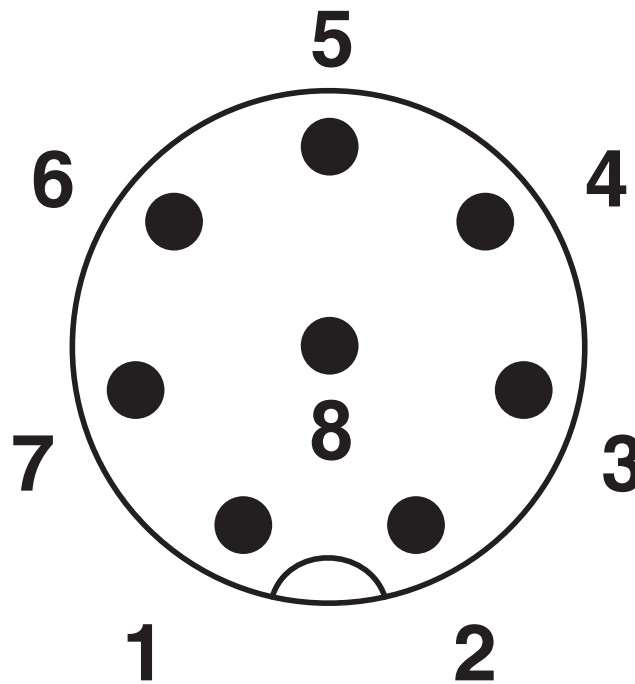

Pin assignment M12 plug, 8-pos., A-coded, view plug side

1406112

<https://www.phoenixcontact.com/us/products/1406112>

Circuit diagram

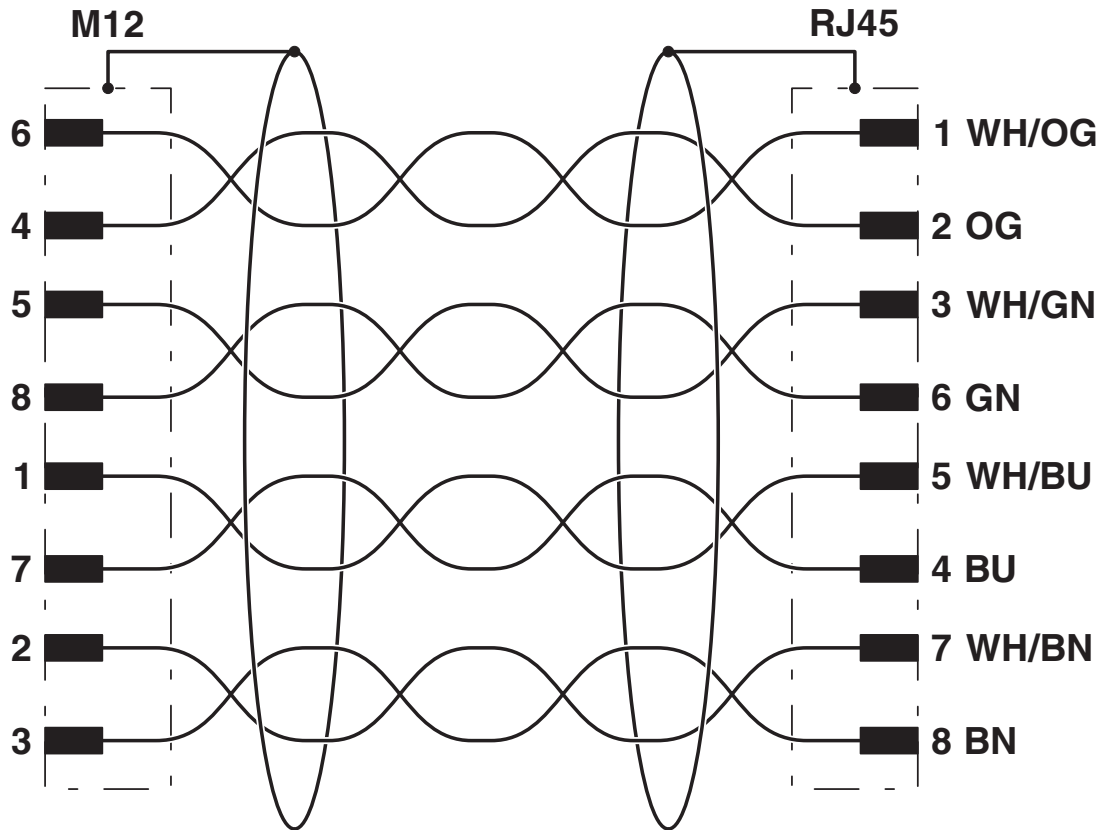



# NBC-MR/ 2,0-94B/R4AC SCO US - Network cable





1406112

<https://www.phoenixcontact.com/us/products/1406112>

## Approvals

To download certificates, visit the product detail page: <https://www.phoenixcontact.com/us/products/1406112>

 <b>UL Listed</b> Approval ID: FILE E 335024	Nominal voltage $U_N$	Nominal current $I_N$	Cross section AWG	Cross section $\text{mm}^2$
	30 V	0.5 A	-	-

 <b>EAC-RoHS</b> Approval ID: RU D-DE.HB35.B.00387
--

1406112

<https://www.phoenixcontact.com/us/products/1406112>

## Classifications

### ECLASS

ECLASS-11.0	27060307
ECLASS-12.0	27060307
ECLASS-13.0	27060307

### ETIM

ETIM 9.0	EC001855
----------	----------

### UNSPSC

UNSPSC 21.0	26121600
-------------	----------

# NBC-MR/ 2,0-94B/R4AC SCO US - Network cable



1406112

<https://www.phoenixcontact.com/us/products/1406112>

## Environmental product compliance

### EU RoHS

Fulfills EU RoHS substance requirements	Yes, No exemptions
---	--------------------

### China RoHS

Environment friendly use period (EFUP)	EFUP-E
	No hazardous substances above the limits

### EU REACH SVHC

REACH candidate substance (CAS No.)	No substance above 0.1 wt%
-------------------------------------	----------------------------

Phoenix Contact 2024 © - all rights reserved  
<https://www.phoenixcontact.com>

Phoenix Contact USA  
586 Fulling Mill Road  
Middletown, PA 17057, United States  
(+717) 944-1300  
[info@phoenixcon.com](mailto:info@phoenixcon.com)