

## DESCRIPTION

The MP4425A is a high-frequency, synchronous, rectified, step-down, switch-mode white LED driver with built-in power MOSFETs. It offers a very compact solution to achieve 1.5A of continuous output current with excellent load and line regulation over a wide input supply range. The MP4425A has synchronous mode operation to get high efficiency.

Current mode operation provides fast transient response and eases loop stabilization.

Full protection features include over-current protection (OCP) and thermal shutdown (TSD).

The MP4425A requires a minimal number of readily available, standard external components, and is available in a space-saving QFN-13 (2.5mmx3mm) package.

## FEATURES

- Wide 4V to 36V Operating Input Range
- 85mΩ/50mΩ Low  $R_{DS(ON)}$  Internal Power MOSFETs
- High-Efficiency Synchronous Mode Operation
- Default 2.2MHz Switching Frequency
- PWM Dimming (Min 100Hz Dimming Frequency)
- Forced CCM Mode
- 0.2V Reference Voltage
- Internal Soft Start
- Fault Indication for LED Short, Open, and Thermal Shutdown
- Over-Current Protection (OCP) with Valley-Current Detection
- Thermal Shutdown
- CISPR25 Class 5 Compliant
- Available in a QFN-13 (2.5mmx3mm) Package

## APPLICATIONS

- Automotive LED Lighting

All MPS parts are lead-free, halogen free, and adhere to the RoHS directive. For MPS green status, visit the MPS website under Quality Assurance. "MPS", the MPS logo, and "Simple, Easy Solutions" are registered trademarks of Monolithic Power Systems, Inc. or its subsidiaries.

## TYPICAL APPLICATION

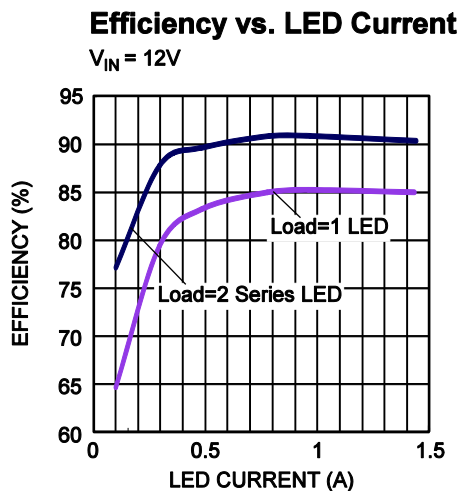
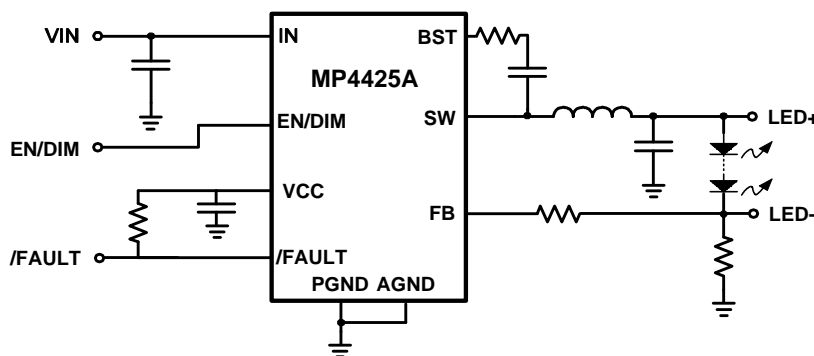

### ORDERING INFORMATION

Part Number *	Package	Top Marking
MP4425AGQB	QFN-13 (2.5mmx3mm)	See Below

\* For Tape & Reel, add suffix -Z (e.g. MP4425AGQB-Z).

### TOP MARKING

BDU

YWW

LLL

BDU: Product code of MP4425AGQB  
 Y: Year code  
 WW: Week code  
 LLL: Lot number

### PACKAGE REFERENCE

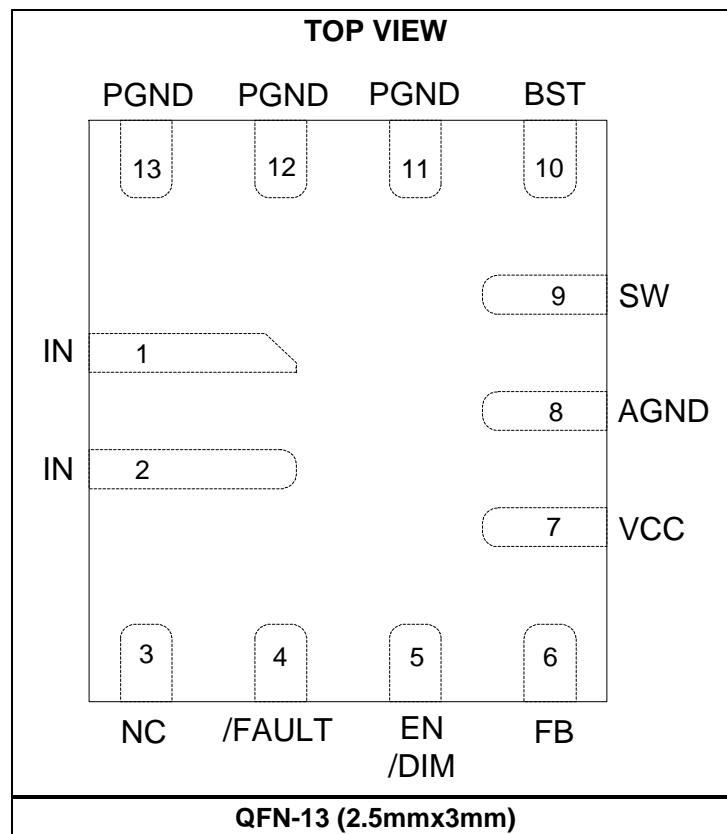

## PIN FUNCTIONS

Pin #	Name	Description
1, 2	IN	<b>Supply voltage.</b> The MP4425A operates from a 4V to 36V input rail. It requires C <sub>IN</sub> to decouple the input rail. Connect using a wide PCB trace.
3	NC	<b>Do not connect.</b>
4	/FAULT	<b>Fault indicator.</b> This open-drain output is pulled low when an LED short, open, or thermal shutdown occurs.
5	EN/DIM	<b>Enable/dimming control.</b> Pull EN high to enable the MP4425A. Apply a 100Hz to 2kHz external clock to the EN/DIM pin for PWM dimming.
6	FB	<b>LED current feedback input.</b>
7	VCC	<b>Internal bias supply.</b> Decouple VCC with a 0.1μF to 0.22μF capacitor. The capacitance should not exceed 0.22μF.
8	AGND	<b>Analog ground.</b> Reference ground of the logic circuit. AGND is connected to PGND internally. There is no need to add external connections to PGND.
9	SW	<b>Switch output.</b> Connect using a wide PCB trace.
10	BST	<b>Bootstrap.</b> Requires a capacitor connected between the SW and BST pins to form a floating supply across the high-side switch driver. It is strongly recommended to place a 20Ω resistor placed between SW and the BST capacitor to reduce the SW spike voltage.
11, 12, 13	PGND	<b>Power ground.</b> PGND is the reference ground of the power device, and requires careful consideration during PCB layout. For best results, connect PGND with copper pours and vias.

### ABSOLUTE MAXIMUM RATINGS <sup>(1)</sup>

Supply voltage (V <sub>IN</sub> )	-0.3V to +40V
Switch voltage (V <sub>SW</sub> )	-0.3V to V <sub>IN</sub> + 0.3V
BST voltage (V <sub>BST</sub> )	V <sub>SW</sub> + 6V
All other pins	-0.3V to +6V <sup>(2)</sup>
Continuous power dissipation (T <sub>A</sub> = 25°C) <sup>(3)</sup>	
QFN-13 (2.5mmx3mm)	2.08W
Junction temperature	150°C
Lead temperature	260°C
Storage temperature	-65°C to +150°C

### Recommended Operating Conditions

Supply voltage (V <sub>IN</sub> )	4V to 36V
LED current (I <sub>LED</sub> )	Up to 1.5A
Operating junction temp (T <sub>J</sub> )	-40°C to +125°C

<b>Thermal Resistance <sup>(4)</sup></b>	<b>θ<sub>JA</sub></b>	<b>θ<sub>JC</sub></b>
QFN-13 (2.5mmx3mm)	60	13 ... °C/W

#### Notes:

- 1) Absolute maximum ratings are rated under room temperature unless otherwise noted. Exceeding these ratings may damage the device.
- 2) For details regarding the EN/DIM pin's ABS MAX rating, see the Enable Control section on page 12.
- 3) The maximum allowable power dissipation is a function of the maximum junction temperature T<sub>J</sub> (MAX), the junction-to-ambient thermal resistance θ<sub>JA</sub>, and the ambient temperature T<sub>A</sub>. The maximum allowable continuous power dissipation at any ambient temperature is calculated by P<sub>D</sub> (MAX) = (T<sub>J</sub> (MAX) - T<sub>A</sub>) / θ<sub>JA</sub>. Exceeding the maximum allowable power dissipation will cause excessive die temperature, and the regulator will go into thermal shutdown. Internal thermal shutdown circuitry protects the device from permanent damage.
- 4) Measured on JESD51-7, 4-layer PCB.

## ELECTRICAL CHARACTERISTICS

$V_{IN} = 12V$ ,  $V_{EN} = 2V$ ,  $T_J = -40^{\circ}C$  to  $+125^{\circ}C$  <sup>(5)</sup>, typical values are at  $T_J = 25^{\circ}C$ , unless otherwise noted.

Parameter	Symbol	Condition	Min	Typ	Max	Units
Supply current (shutdown)	$I_{IN}$	$V_{EN} = 0V$		12		$\mu A$
Supply current (quiescent)	$I_Q$	$V_{EN} = 2V$ , $V_{FB} = 1V$ , no switching		0.6	0.8	mA
HS switch on resistance	$HS_{RDS-ON}$	$V_{BST-SW} = 5V$		85	150	m $\Omega$
LS switch on resistance	$LS_{RDS-ON}$	$V_{CC} = 5V$		50	105	m $\Omega$
Switch leakage	$SW_{LKG}$	$V_{EN} = 0V$ , $V_{SW} = 12V$			1	$\mu A$
Current limit <sup>(6)</sup>	$I_{LIMIT}$	Under 40% duty cycle	2.5	4	5.5	A
Reverse current limit				1.2		A
Oscillator frequency	$f_{SW}$	$V_{FB} = 100mV$	1800	2200	2600	kHz
Maximum duty cycle	$D_{MAX}$	$V_{FB} = 100mV$	80	87		%
Minimum on time <sup>(6)</sup>	$TON_{MIN}$			46		ns
Feedback voltage	$V_{FB}$	$T_J = 25^{\circ}C$	192	200	208	mV
		$T_J = -40^{\circ}C$ to $+125^{\circ}C$	184	200	216	
Feedback current	$I_{FB}$	$V_{FB} = 250mV$		30	100	nA
EN rising threshold	$V_{EN\_RISING}$		1.1	1.45	1.8	V
EN falling threshold	$V_{EN\_FALLING}$		0.7	1	1.3	V
EN threshold hysteresis	$V_{EN\_HYS}$			450		mV
EN input current	$I_{EN}$	$V_{EN} = 2V$		5	10	$\mu A$
		$V_{EN} = 0$		0	0.2	$\mu A$
EN turn-off delay	$EN_{td-off}$		10	25	50	ms
VIN under-voltage lockout threshold rising	$INUV_{Vth}$		3.2	3.5	3.8	V
VIN under-voltage lockout threshold falling			2.8	3.1	3.5	V
VIN under-voltage lockout threshold hysteresis	$INUV_{HYS}$			400		mV
Over-voltage detection (/FAULT pulled low)	$FT_{Vth-Hi}$			140%		$V_{FB}$
Over-voltage detection hysteresis				20%		$V_{FB}$
/FAULT delay	$FT_{Td}$			10		$\mu s$
/FAULT sink current capability	$V_{FT}$	Sink 4mA			0.4	V
/FAULT leakage current	$I_{FT-LEAK}$				100	nA
VCC regulator	$V_{CC}$	$I_{CC} = 0mA$	4.6	4.9	5.2	V
VCC load regulation		$I_{CC} = 5mA$		1.5	4	%
Soft-start time <sup>(6)</sup>	$t_{SS}$	$I_{LED} = 1.5A$ , $L = 2.2\mu H$ , load = 2 series LED, $I_{LED}$ from 10% to 90%		0.9		ms
Thermal shutdown <sup>(6)</sup>			150	170		$^{\circ}C$
Thermal hysteresis <sup>(6)</sup>				30		$^{\circ}C$

### Notes:

- 5) Not tested in production. Guaranteed by over-temperature correlation.  
 6) Not tested in production. Guaranteed by design and characterization.

## TYPICAL CHARACTERISTICS

**$I_Q$  vs. Temperature**

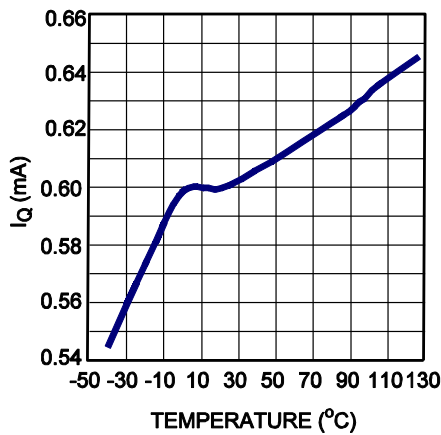

**$V_{IN}$  UVLO vs. Temperature**

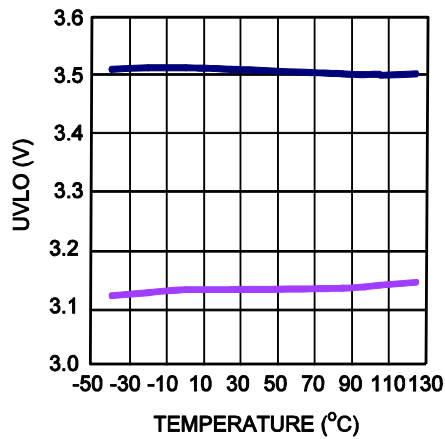

**$V_{FB}$  vs. Temperature**

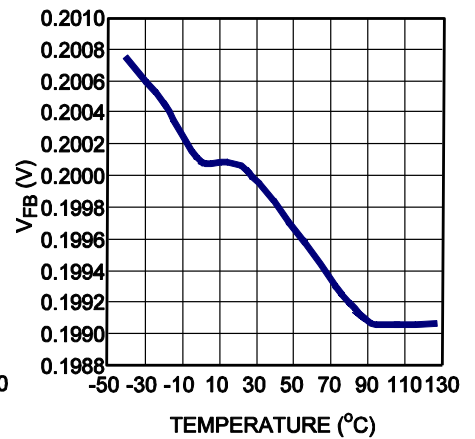

**Current Limit vs. Temperature**

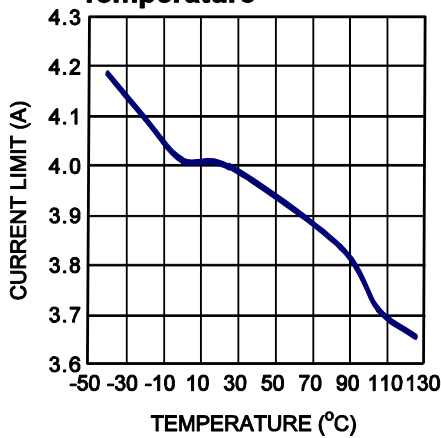

## TYPICAL PERFORMANCE CHARACTERISTICS

$V_{IN} = 12V$ , load = 2 series LED,  $L = 2.2\mu H$ ,  $f_{SW} = 2.2MHz$ ,  $T_A = 25^\circ C$ , unless otherwise noted.

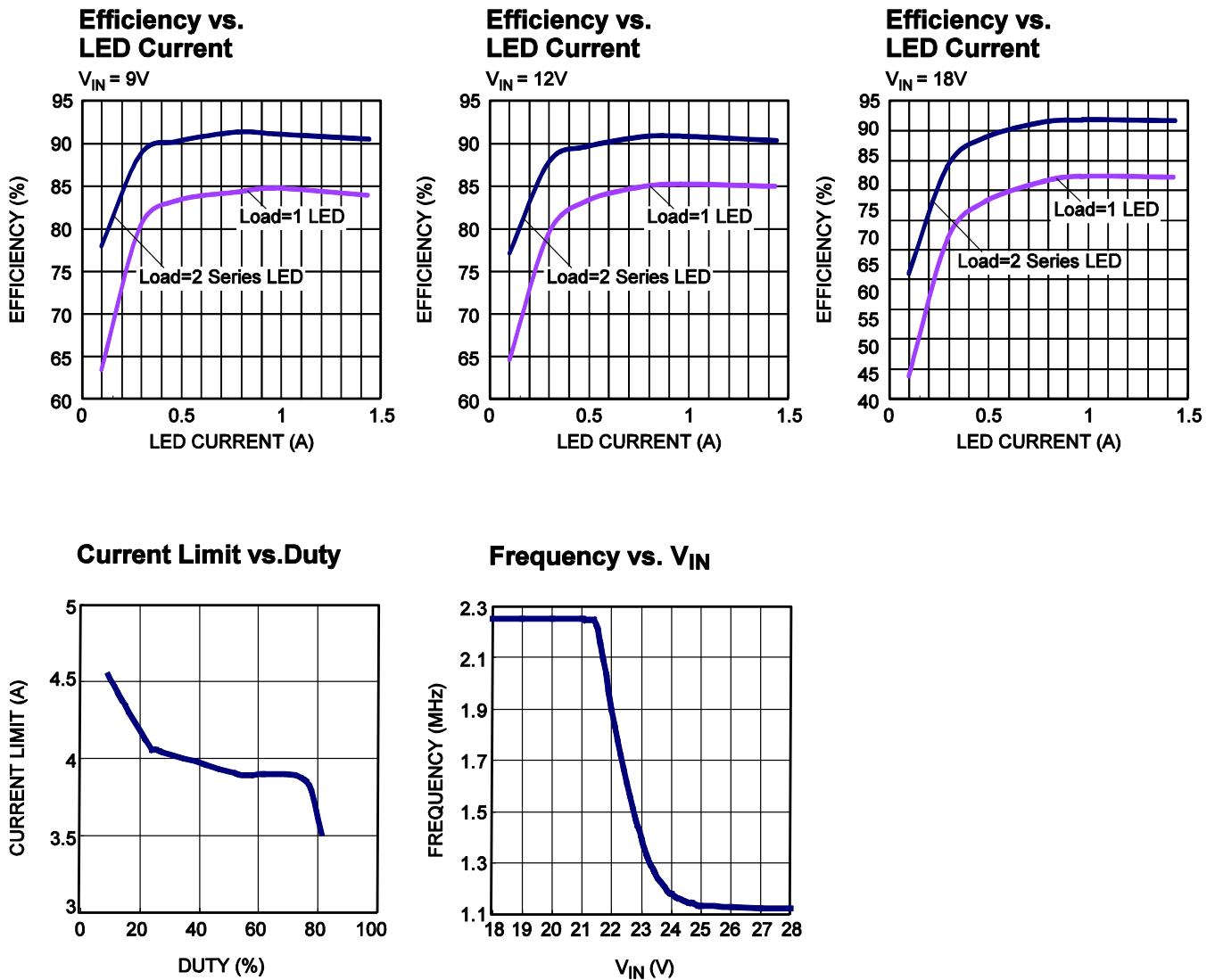

**TYPICAL PERFORMANCE CHARACTERISTICS (continued)**
 $V_{IN} = 12V$ , load = 2 series LED,  $L = 2.2\mu H$ ,  $f_{SW} = 2.2MHz$ ,  $T_A = 25^\circ C$ , unless otherwise noted.

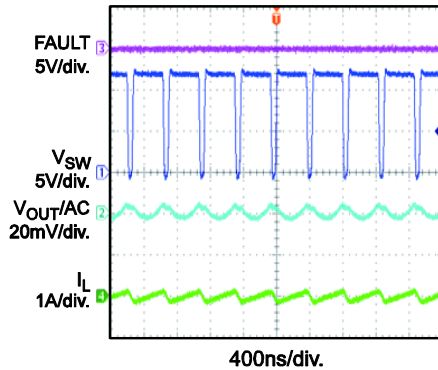
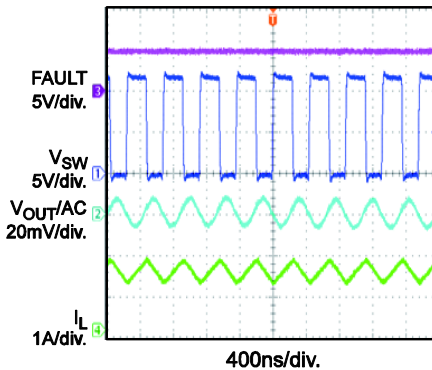
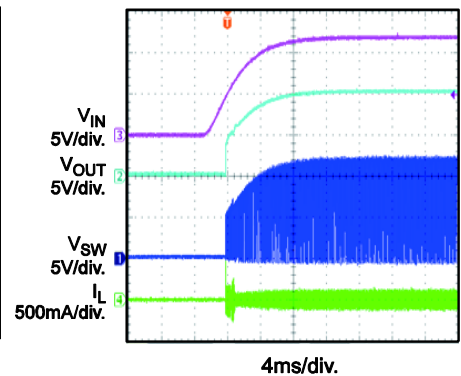
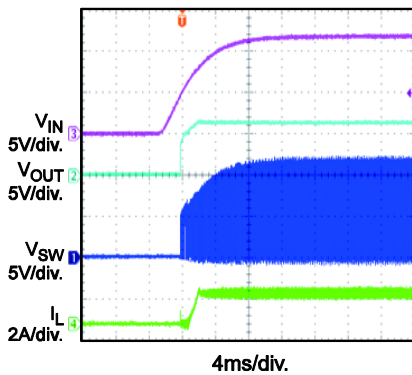
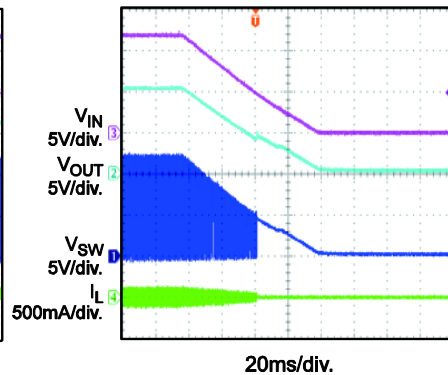
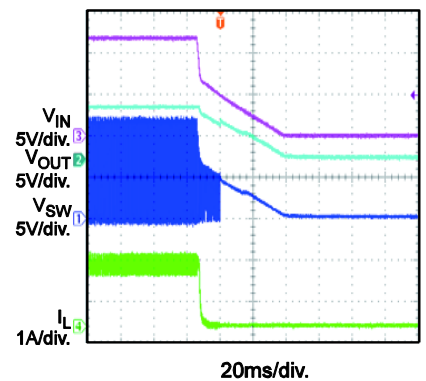
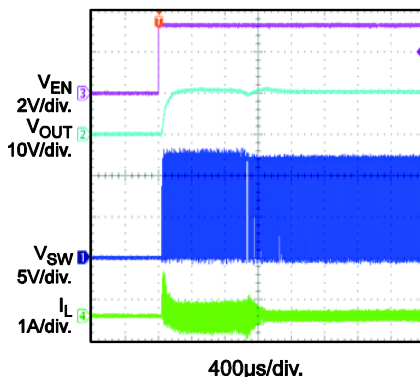
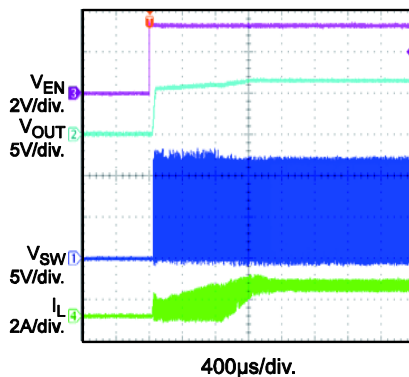
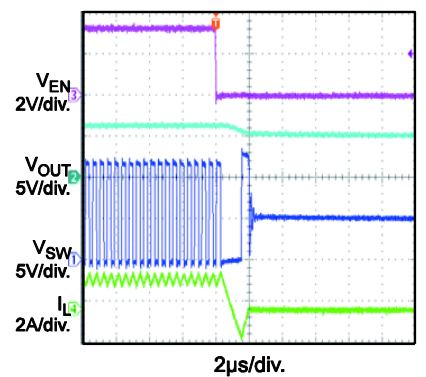
**Steady State**
 $I_{LED} = 0A$ 

**Steady State**
 $I_{LED} = 1.5A$ 

**Start-Up through V\_IN**
 $I_{LED} = 0A$ 

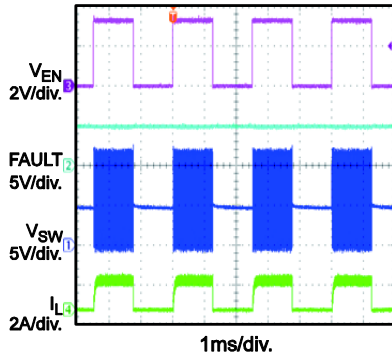
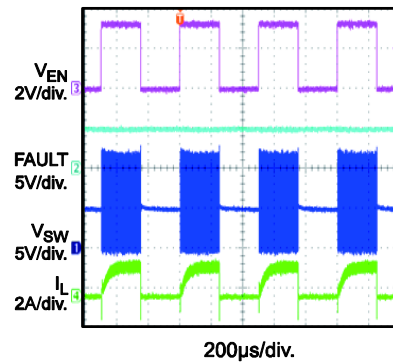
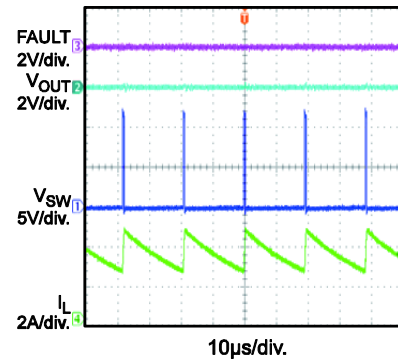
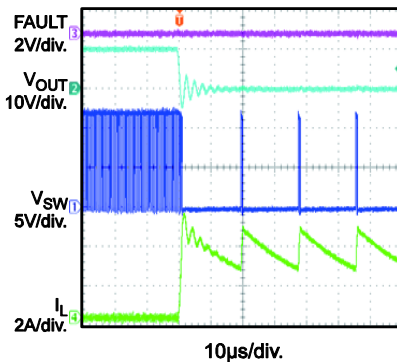
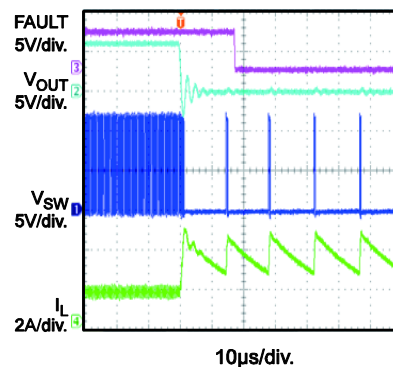
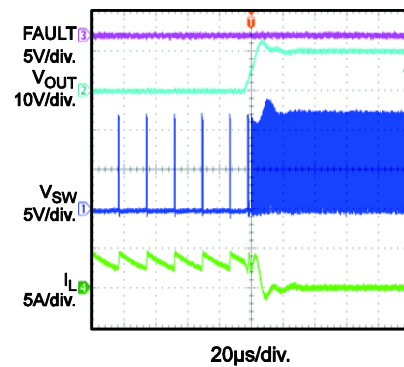
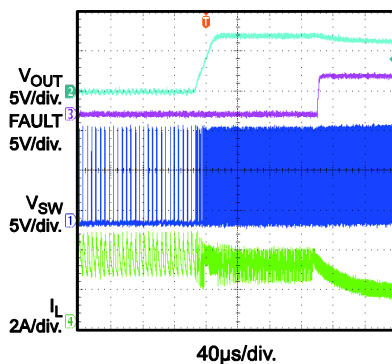
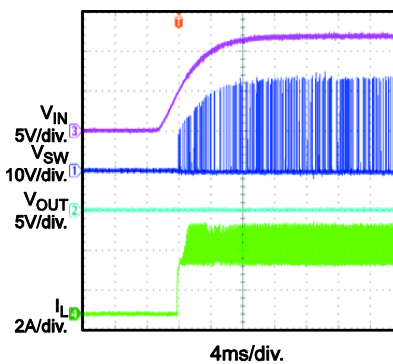
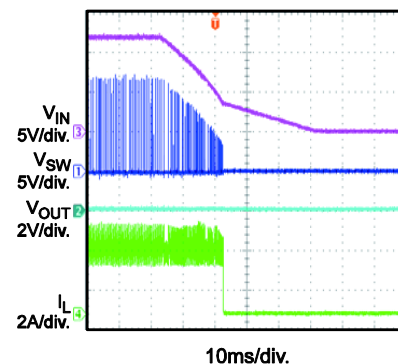
**Start-Up through V\_IN**
 $I_{LED} = 1.5A$ 

**Shutdown through V\_IN**
 $I_{LED} = 0A$ 

**Shutdown through V\_IN**
 $I_{LED} = 1.5A$ 

**Start-Up through EN**
 $I_{LED} = 0A$ 

**Start-Up through EN**
 $I_{LED} = 1.5A$ 

**Shutdown through EN**
 $I_{LED} = 1.5A$ 



**TYPICAL PERFORMANCE CHARACTERISTICS (continued)**
 $V_{IN} = 12V$ , load = 2 series LED,  $L = 2.2\mu H$ ,  $f_{SW} = 2.2MHz$ ,  $T_A = 25^\circ C$ , unless otherwise noted.

**PWM Dimming**  
400Hz

**PWM Dimming**  
2kHz

**LED+ Short to GND**  
Steady State

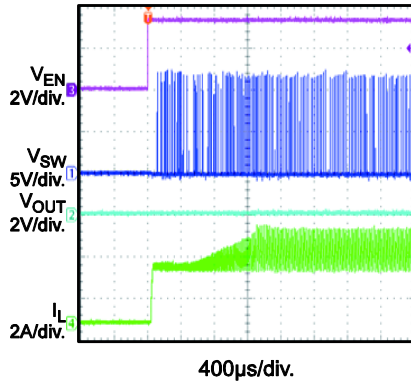
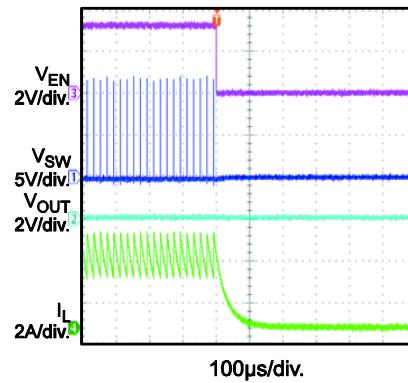
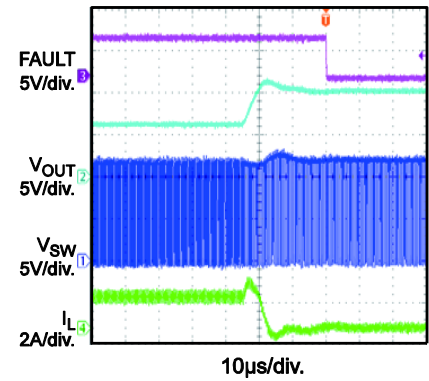
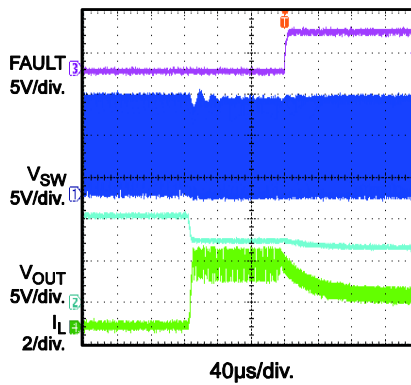
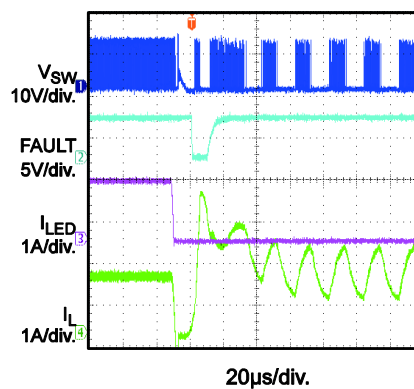
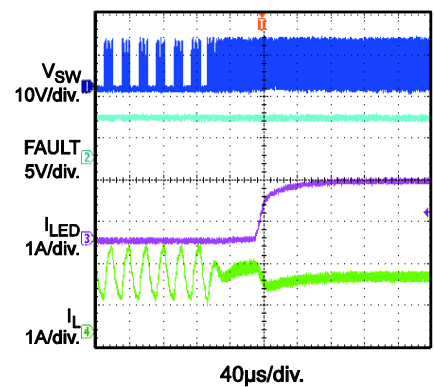
**LED+ Short to GND Entry**  
 $I_{LED} = 0A$ 

**LED+ Short to GND Entry**  
 $I_{LED} = 1.5A$ 

**LED+ Short to GND Recovery**  
 $I_{LED} = 0A$ 

**LED+ Short to GND Recovery**  
 $I_{LED} = 1.5A$ 

**LED+ Short to GND**  
Input Power On

**LED+ Short to GND**  
Input Power Off



**TYPICAL PERFORMANCE CHARACTERISTICS (continued)**
 $V_{IN} = 12V$ , load = 2 series LED,  $L = 2.2\mu H$ ,  $f_{SW} = 2.2MHz$ ,  $T_A = 25^\circ C$ , unless otherwise noted.

**LED+ Short to GND EN On**

**LED+ Short to GND EN Off**

**LED Open Entry**

**LED Open Recovery**

**LED+ and LED- Short Entry**

**LED+ and LED- Short Recovery**

### FUNCTIONAL BLOCK DIAGRAM

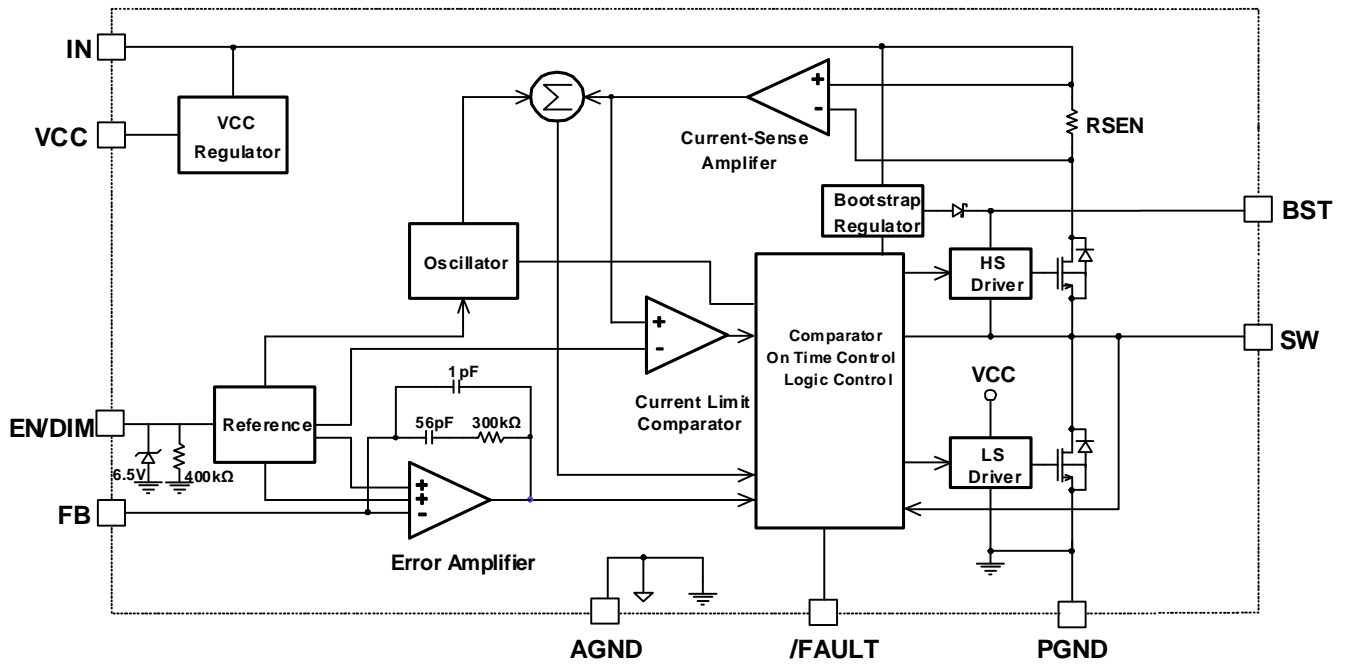

Figure 1: Functional Block Diagram

## OPERATION

The MP4425A is a high-frequency, synchronous, rectified, step-down, switch-mode white LED driver with built-in power MOSFETs. It offers a very compact solution to achieve 1.5A continuous output current with excellent load and line regulation over a 4V to 36V input supply range.

The MP4425A operates in fixed-frequency, peak current control mode to regulate the output current. An internal clock initiates a PWM cycle. The integrated high-side power MOSFET turns on, and remains on until its current reaches the value set by the COMP voltage ( $V_{COMP}$ ). When the power switch is off, it remains off until the next clock cycle starts. If the current in the power MOSFET does not reach the current value set by  $V_{COMP}$  within 87% of one PWM period, the power MOSFET is forced off.

### Internal Regulator

The 4.9V internal regulator powers most of the internal circuitries. This regulator takes  $V_{IN}$  and operates in the full  $V_{IN}$  range. When  $V_{IN}$  exceeds 4.9V, the output of the regulator is in full regulation. When  $V_{IN}$  falls below 4.9V, the output decreases following  $V_{IN}$ . A 0.1 $\mu$ F decoupling ceramic capacitor is needed at VCC.

### CCM Operation

The MP4425A uses continuous conduction modulation (CCM) mode to ensure that the part works with fixed frequency across the no load to full load range. The advantage of CCM is the controllable frequency and lower output ripple at light load.

### Frequency Foldback

The MP4425A enters frequency foldback when the input voltage exceeds about 21V. The frequency decreases to half the nominal value and changes to 1.1MHz.

Frequency foldback also occurs during soft start and short-circuit protection.

### Error Amplifier (EA)

The error amplifier compares the FB pin voltage to the internal 0.2V reference ( $V_{REF}$ ) and outputs a current proportional to the difference

between the two. This output current then charges or discharges the internal compensation network to form  $V_{COMP}$ , which controls the power MOSFET current. The optimized internal compensation network minimizes the external component counts and simplifies control loop design.

### Enable Control (EN)

EN/DIM is a control pin that turns the regulator on and off. Drive EN/DIM high to turn on the regulator; drive it low to turn it off. An internal 400k $\Omega$  resistor from EN/DIM to GND allows EN/DIM to be floated to shut down the chip.

EN/DIM is clamped internally using a 6.5V series Zener diode (see Figure 2). Connect EN/DIM input through a pull-up resistor to the voltage on  $V_{IN}$  to limit the EN input current to less than 100 $\mu$ A.

For example, with 12V connected to  $V_{IN}$ ,  $R_{PULLUP} \geq (12V - 6.5V) \div 100\mu A = 55k\Omega$ .

Connecting EN/DIM to a voltage source directly without a pull-up resistor requires limiting the amplitude of the voltage source to  $\leq 6V$  to prevent damage to the Zener diode.

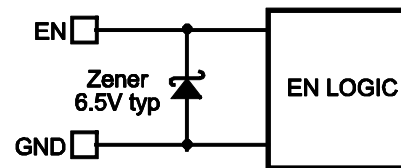

**Figure 2: 6.5V Zener Diode Connection**

Driving EN/DIM low for longer than 25ms will shut down the IC.

### PWM Dimming

Apply an external 100Hz to 2kHz PWM waveform to EN/DIM for PWM dimming. The average LED current is proportional to PWM duty. The minimum amplitude of the PWM signal is 1.8V. If the dimming signal is applied before the chip starts up, the signal on time must be longer than 2ms to ensure that soft start finishes, so the output current can be built. If the dimming signal is applied after soft start finishes, the above 2ms limit is not required.

### Under-Voltage Lockout (UVLO)

Under-voltage lockout (UVLO) protects the chip

from operating at an insufficient supply voltage. The UVLO comparator monitors the output voltage of the internal regulator (VCC).

### Internal Soft Start (SS)

Soft start (SS) prevents the converter output voltage from overshooting during start-up. When the chip starts up, the internal circuitry generates a soft-start voltage ( $V_{SS}$ ). When  $V_{SS}$  is below the internal reference ( $V_{REF}$ ),  $V_{SS}$  overrides  $V_{REF}$ , so the error amplifier uses  $V_{SS}$  as the reference. When  $V_{SS}$  exceeds  $V_{REF}$ , the error amplifier uses  $V_{REF}$  as the reference.

### Fault Indicator

The MP4425A has fault indication. The /FAULT pin is the open drain of a MOSFET, and should be connected to VCC or some other voltage source through a resistor (e.g. 100k $\Omega$ ). The /FAULT pin is pulled high during normal operation. An LED short, open, or thermal shutdown pulls this pin down to indicate a fault status.

### Over-Current Protection (OCP)

The MP4425A has cycle-by-cycle peak current-limit protection with valley current detection. The inductor current is monitored during the high-side MOSFET (HS-FET) on state. If the inductor current exceeds the current-limit value set by the COMP high-clamp voltage, the HS-FET turns off immediately. Then the low-side MOSFET (LS-FET) turns on to discharge the energy, and the inductor current decreases. The HS-FET remains off unless the inductor valley current is below a certain current threshold (the valley current limit), even though the internal clock pulses high. If the inductor current does not drop below the valley current limit when the internal clock pulses high, the HS-FET misses the clock, and the switching frequency falls to half the nominal value. Both the peak and valley current limits assist in keeping the inductor current from running away during an overload or short-circuit condition.

### Thermal Shutdown (TSD)

Thermal shutdown prevents the chip from operating at exceedingly high temperatures. When the die temperature exceeds 170°C, the entire chip shuts down. When the temperature

drops below its lower threshold (typically 140°C), the chip is enabled again.

### Floating Driver and Bootstrap Charging

An external bootstrap capacitor powers the floating power MOSFET driver. This floating driver has its own UVLO protection, with a rising threshold of 2.2V and hysteresis of 150mV. The bootstrap capacitor voltage is regulated internally by  $V_{IN}$  through D1, M1, C3, L1, and C4 (see Figure 3).

If  $V_{IN} - V_{SW}$  exceeds 5V, U1 regulates M1 to maintain a 5V BST voltage across C4. As long as  $V_{IN}$  is sufficiently higher than SW, the bootstrap capacitor can be charged. When the HS-FET is on,  $V_{IN} \approx V_{SW}$ , the bootstrap capacitor cannot be charged. When the LS-FET is on,  $V_{IN} - V_{SW}$  reaches its maximum for fast charging. When there is no inductor current,  $V_{SW} = V_{OUT}$ , so the difference between  $V_{IN}$  and  $V_{OUT}$  can charge the bootstrap capacitor. It is strongly recommended to place a 20 $\Omega$  resistor placed between SW and the BST capacitor to reduce the SW spike voltage.

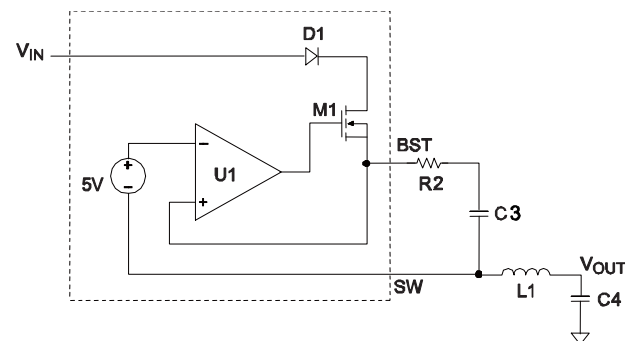

**Figure 3: Internal Bootstrap Charging Circuit**

### Start-Up and Shutdown

If both  $V_{IN}$  and EN exceed their appropriate thresholds, the chip starts up. The reference block starts first, generating a stable reference voltage and currents, and then the internal regulator is enabled. The regulator provides a stable supply for the remaining circuitries.

Three events can shut down the chip:  $V_{IN}$  low, EN low, and thermal shutdown. During the shutdown procedure, the signaling path is first blocked to avoid any fault triggering.  $V_{COMP}$  and the internal supply rail are then pulled down. The floating driver is not subject to this shutdown command.

## APPLICATION INFORMATION

### Setting the Output Current

The output current is set by the external resistor  $R_{FB}$  (see Figure 4).

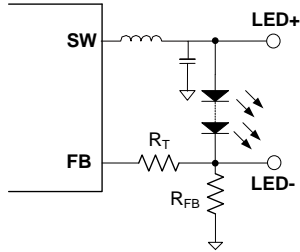

**Figure 4: Feedback Network**

The feedback reference voltage is 0.2V, and  $I_{LED}$  is determined with Equation (1):

$$I_{LED} = \frac{0.2V}{R_{FB}} \quad (1)$$

$R_T$  sets the loop bandwidth. The lower the value of  $R_T$ , the higher the bandwidth. High bandwidth may cause an insufficient phase margin, resulting in loop instability. Therefore, a proper  $R_T$  value is needed to make a trade-off between bandwidth and phase margin. Table 1 lists the recommended feedback resistor and  $R_T$  values for common outputs with a 1 or 2 series LED.

**Table 1: Resistor Selection for Common Outputs**

$I_{LED}$ (A)	$R_{FB}$ (m $\Omega$ )	$R_T$ (k $\Omega$ )
0.5	400 (1%)	200 (1%)
1	200 (1%)	150 (1%)
1.5	133 (1%)	100 (1%)

### Selecting the Input Capacitor

The step-down converter has a discontinuous input current, and requires a capacitor to supply the AC current to the converter while maintaining the DC input voltage. For the best performance, use low-ESR capacitors. Ceramic capacitors with X5R or X7R dielectrics are highly recommended because of their low ESR and small temperature coefficients.

For most applications, use a 4.7 $\mu$ F to 10 $\mu$ F capacitor. It is strongly recommended to use another, lower-value capacitor (e.g. 0.1 $\mu$ F) with a small package size (0603) to absorb high-frequency switching noise. Be sure to place the small-sized capacitor as close to the IN and

GND pins as possible. Since  $C_{IN}$  absorbs the input switching current, it requires an adequate ripple current rating. Estimate the RMS current in the input capacitor with Equation (2):

$$I_{CIN} = I_{LED} \times \sqrt{\frac{V_{OUT}}{V_{IN}} \times \left(1 - \frac{V_{OUT}}{V_{IN}}\right)} \quad (2)$$

The worst-case condition occurs at  $V_{IN} = 2V_{OUT}$ , calculated with Equation (3):

$$I_{CIN} = \frac{I_{LED}}{2} \quad (3)$$

For simplification, choose an input capacitor with an RMS current rating greater than half of the maximum load current.

The input capacitor can be electrolytic, tantalum, or ceramic. When using electrolytic or tantalum capacitors, add a small, high-quality ceramic capacitor (e.g. 0.1 $\mu$ F) close to the IC. When using ceramic capacitors, ensure they have enough capacitance to provide a sufficient charge to prevent excessive voltage ripple at the input. Estimate the input voltage ripple caused by capacitance with Equation (4):

$$\Delta V_{IN} = \frac{I_{LED}}{f_{SW} \times C_{IN}} \times \frac{V_{OUT}}{V_{IN}} \times \left(1 - \frac{V_{OUT}}{V_{IN}}\right) \quad (4)$$

### Selecting the Output Capacitor

The output capacitor maintains the DC output voltage. Use ceramic, tantalum, or low-ESR electrolytic capacitors. For best results, use low-ESR capacitors to keep the output voltage ripple low. The output voltage ripple can be estimated with Equation (5):

$$\Delta V_{OUT} = \frac{V_{OUT}}{f_{SW} \times L} \cdot \left(1 - \frac{V_{OUT}}{V_{IN}}\right) \cdot \left(R_{ESR} + \frac{1}{8f_{SW} \times C_{OUT}}\right) \quad (5)$$

Where L is the inductor value and  $R_{ESR}$  is the equivalent series resistance (ESR) value of the output capacitor.

For ceramic capacitors, the capacitance dominates the impedance at the switching frequency, and causes most of the output voltage ripple. For simplification, estimate the output voltage ripple with Equation (6):

$$\Delta V_{OUT} = \frac{V_{OUT}}{8 \times f_{SW}^2 \times L \times C_{OUT}} \times \left(1 - \frac{V_{OUT}}{V_{IN}}\right) \quad (6)$$



For tantalum or electrolytic capacitors, the ESR dominates the impedance at the switching frequency. For simplification, estimate the output ripple with Equation (7):

$$\Delta V_{OUT} = \frac{V_{OUT}}{f_{SW} \times L} \times \left(1 - \frac{V_{OUT}}{V_{IN}}\right) \times R_{ESR} \quad (7)$$

The characteristics of the output capacitor also affect the stability of the regulation system. The MP4425A can be optimized for a wide range of capacitance and ESR values.

### Selecting the Inductor

A 1μH to 10μH inductor with a DC current rating at least 25% greater than the maximum load current is recommended for most applications. For higher efficiency, choose an inductor with lower DC resistance. A larger-value inductor results in less ripple current and a lower output ripple voltage. However, the larger-value inductor also has a larger physical size, higher series resistance, and lower saturation current. A good rule for determining the inductor value is to allow the inductor ripple current to be approximately 30% of the maximum load current. Calculate the inductance value with Equation (8):

$$L = \frac{V_{OUT}}{f_{SW} \times \Delta I_L} \times \left(1 - \frac{V_{OUT}}{V_{IN}}\right) \quad (8)$$

Where  $\Delta I_L$  is the peak-to-peak inductor ripple current.

Choose the inductor ripple current to be approximately 30% of the maximum load current. Calculate the maximum inductor peak current with Equation (9):

$$I_{LP} = I_{LED} + \frac{V_{OUT}}{2f_{SW} \times L} \times \left(1 - \frac{V_{OUT}}{V_{IN}}\right) \quad (9)$$

### V<sub>IN</sub> UVLO Setting

The MP4425A has an internal fixed under-voltage lockout (UVLO) threshold. The rising threshold is 3.5V, while the falling threshold is about 3.1V. If the application requires a higher UVLO point, an external resistor divider between the IN and EN/DIM pins can be used to get a higher equivalent UVLO threshold (see Figure 5).

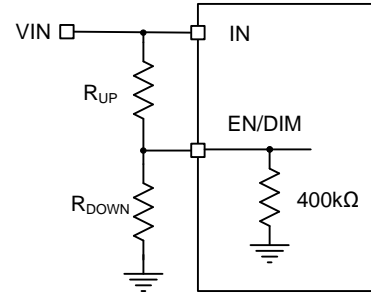

**Figure 5: Adjustable UVLO Using EN Divider**

Calculate the UVLO threshold with Equation (10) and Equation (11):

$$INUV_{RISING} = \left(1 + \frac{R_{UP}}{400k\Omega/R_{DOWN}}\right) \times V_{EN\_RISING} \quad (10)$$

$$INUV_{FALLING} = \left(1 + \frac{R_{UP}}{400k\Omega/R_{DOWN}}\right) \times V_{EN\_FALLING} \quad (11)$$

Where  $V_{EN\_RISING} = 1.45V$ ,  $V_{EN\_FALLING} = 1V$ .

When choosing  $R_{UP}$ , ensure it is large enough to limit the current flows into the EN/DIM pin to below 100μA.

### BST Resistor and External BST Diode

A 20Ω resistor in series with a BST capacitor is recommended to reduce the SW spike voltage. Higher resistance is better for SW spike reduction, but also compromises efficiency.

An external BST diode can enhance the efficiency of the regulator when the duty cycle is high (>65%). A power supply between 2.5V and 5V can be used to power the external bootstrap diode, and VCC or V<sub>OUT</sub> is the best choice for this power supply in the circuit (see Figure 6).

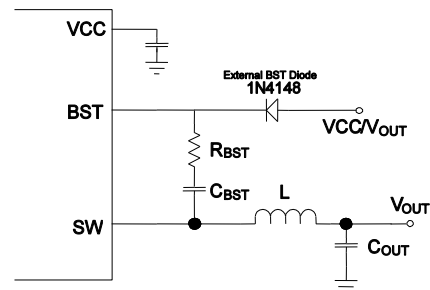

**Figure 6: Optional External Bootstrap Diode to Enhance Efficiency**

The recommended external BST diode is 1N4148, and the recommended BST capacitor value is 0.1μF to 1μF.

**PCB Layout Guidelines <sup>(7)</sup>**

Efficient PCB layout, especially input capacitor placement, is critical for stable operation. A 4-layer layout is strongly recommended to achieve better thermal performance. For best results, refer to Figure 7 and follow the guidelines below:

1. Use a large ground plane to connect directly to PGND. If the bottom layer is a ground plane, add vias near PGND.
2. Use multiple vias to connect the power planes to internal layers.
3. Ensure that the high-current paths at PGND and IN have short, direct, and wide traces.
4. Place the ceramic input capacitor, especially the small-package (0603) input bypass capacitor, as close to the IN and PGND pins as possible to minimize high-frequency noise.
5. Keep the connection between the input capacitor and IN as short and wide as possible.
6. Place the VCC capacitor as close to the VCC and GND pins as possible.
7. Route SW and BST away from sensitive analog areas, such as FB.
8. Place the feedback resistors close to the chip to ensure the trace that connects to the FB pin is as short as possible.

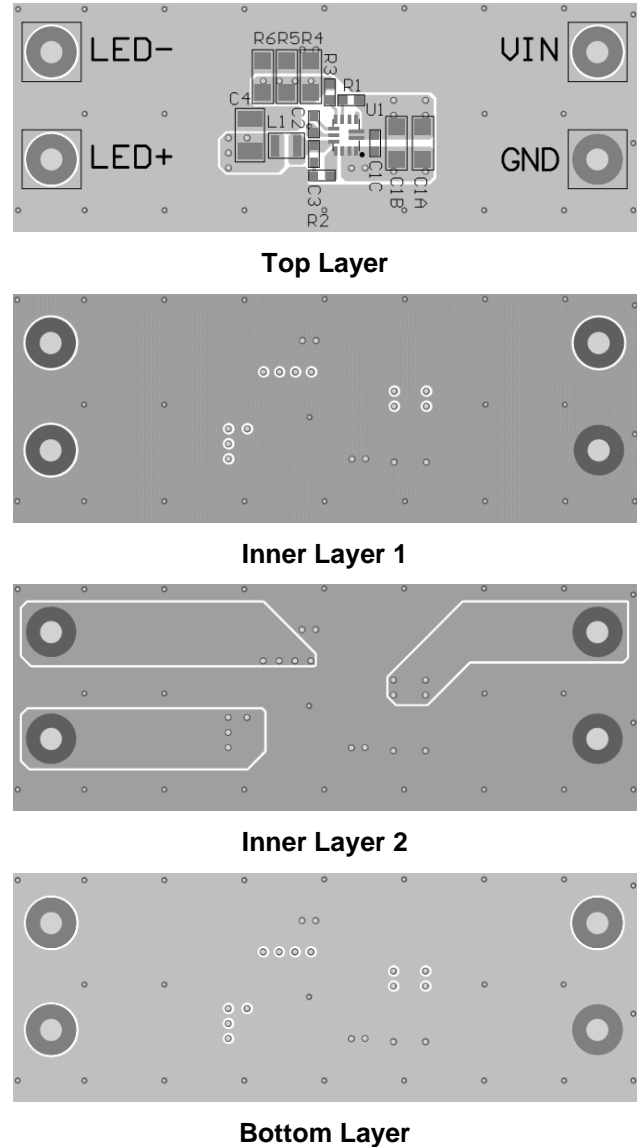
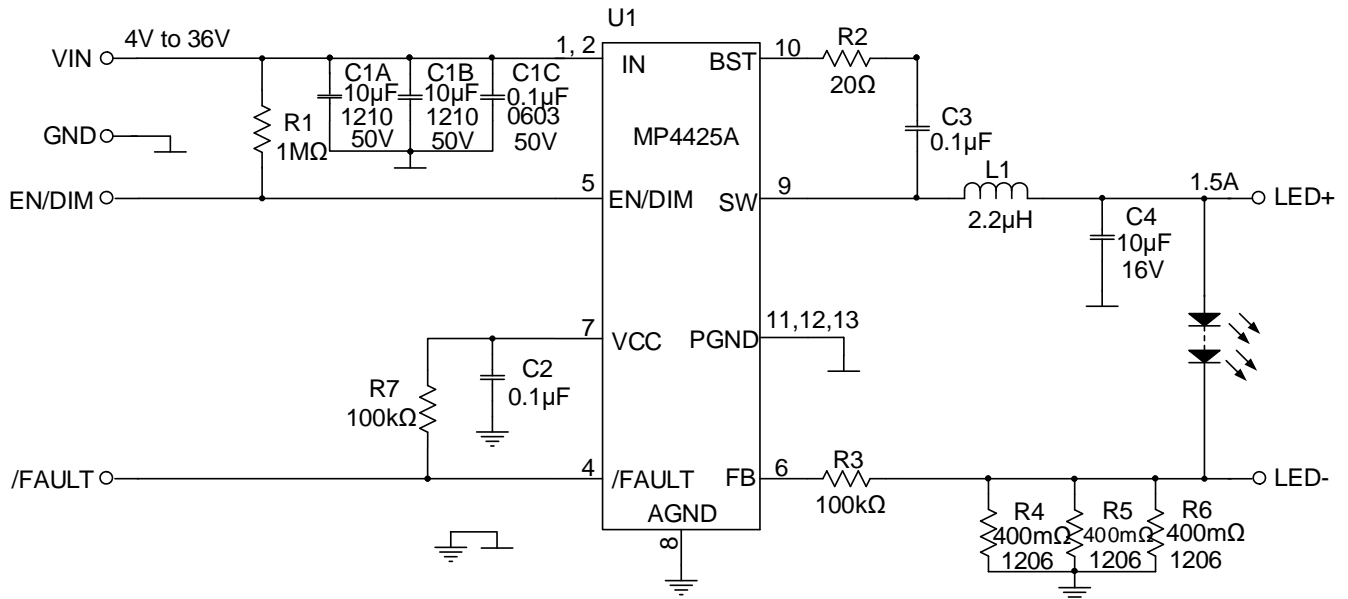
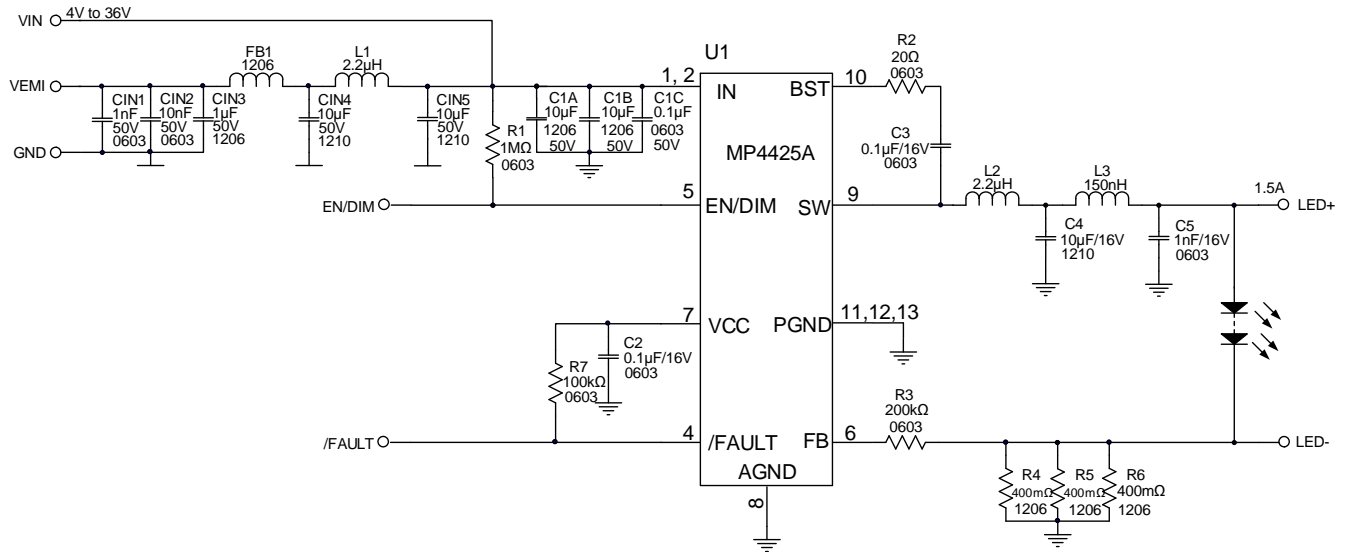

**Figure 7: Recommended PCB Layout**

**Note:**

- 7) The recommended layout is based on the Typical Application Circuits on page 17.



**TYPICAL APPLICATION CIRCUIT**

**Figure 8:  $I_o = 1.5A$  Application Circuit**

**Figure 9:  $I_o = 1.5A$  Application Circuit with EMI Filters**

