



## Main

Range of Product	Telemecanique Limit switches XC Standard
Series name	Standard format
Product or Component Type	Limit switch
Device short name	XCKP
Sensor design	Compact form B CENELEC EN 50047
Body type	Fixed
Head type	Plunger head
Material	Plastic
Body Material	Plastic
Head material	Zamak
Fixing Mode	By the body
Movement of operating head	Linear
Type of operator	Spring return plunger metal
Type of approach	Vertical approach, 1 direction
Number of poles	2
Contacts type and composition	1 NC + 1 NO
Contact operation	Snap action

## Complementary

Switch actuation	On end
Electrical connection	Screw-clamp terminals 1 x 0.34...2 x 1.5 mm <sup>2</sup>
Cable entry	1 entry tapped for Pg 11 cable gland
Contacts insulation form	Zb
Positive opening	With
Positive opening minimum force	45 N
Minimum force for tripping	15 N
Minimum actuation speed	0.01 m/min
Maximum actuation speed	1.64 ft/s (0.5 m/s)
Repeat accuracy	0.1 mm on the tripping points with 1 million operating cycles
Contact code designation	A300, AC-15 (U <sub>e</sub> = 240 V), I <sub>e</sub> = 3 A 10 A EN/IEC 60947-5-1 appendix A Q300, DC-13 (U <sub>e</sub> = 250 V), I <sub>e</sub> = 0.27 A EN/IEC 60947-5-1 appendix A
[Ui] rated insulation voltage	300 VUL 508 500 V 3)IEC 60947-1 300 VCSA C22.2 No 14
Maximum resistance across terminals	25 MOhm IEC 60255-7 category 3
[Uimp] rated impulse withstand voltage	6 kV IEC 60664 6 kV IEC 60947-1
Short-circuit protection	10 A cartridge fuse gG
Electrical durability	5000000 Cycles, DC-13, 120 V, 4 W 60 cyc/mn 0.5 IEC 60947-5-1 appendix C 5000000 Cycles, DC-13, 24 V, 10 W 60 cyc/mn 0.5 IEC 60947-5-1 appendix C 5000000 cycles, DC-13, 48 V, 7 W 60 cyc/mn 0.5 IEC 60947-5-1 appendix C
Mechanical durability	15000000 cycles
Width	1.22 in (31 mm)
Height	2.56 in (65 mm)
Depth	1.18 in (30 mm)

The information provided in this documentation contains general descriptions and/or technical characteristics of the performance of the products contained herein. This documentation is not intended as a substitute for and is not to be used for determining suitability or reliability of these products for specific user applications. It is the duty of any such user or integrator to perform the appropriate and complete risk analysis, evaluation and testing of the products with respect to the relevant specific application or use thereof. Neither Schneider Electric Industries SAS nor any of its affiliates or subsidiaries shall be responsible or liable for misuse of the information contained herein.

Net Weight	0.20 lb(US) (0.09 kg)
Terminals description ISO n°1	(13-14)NO (21-22)NC

## Environment

Shock resistance	50 gn 11 ms IEC 60068-2-27
Vibration resistance	25 gn 10...500 Hz)IEC 60068-2-6
IP degree of protection	IP66 conforming to IEC 60529 IP67 conforming to IEC 60529
IK degree of protection	IK04 EN 50102
Electrical shock protection class	Class II IEC 61140 Class II NF C 20-030
Ambient Air Temperature for Operation	-13...158 °F (-25...70 °C)
Ambient Air Temperature for Storage	-40...158 °F (-40...70 °C)
Protective treatment	TC
Product Certifications	CSA UL CCC
Standards	EN 60947-5-1 CSA C22.2 No 14 IEC 60947-5-1 EN 60204-1 IEC 60204-1 UL 508



## Ordering and shipping details

Category	22418-LIMIT SWITCH,IEC,XCKP&XCKT
Discount Schedule	T
GTIN	3389110316636
Returnability	No
Country of origin	FR

## Packing Units

Unit Type of Package 1	PCE
Number of Units in Package 1	1
Package 1 Height	1.73 in (4.400 cm)
Package 1 Width	1.81 in (4.600 cm)
Package 1 Length	3.19 in (8.100 cm)
Package 1 Weight	2.50 oz (71.000 g)
Unit Type of Package 2	S02
Number of Units in Package 2	81
Package 2 Height	5.91 in (15.000 cm)
Package 2 Width	11.81 in (30.000 cm)
Package 2 Length	15.75 in (40.000 cm)
Package 2 Weight	13.82 lb(US) (6.270 kg)

## Offer Sustainability

Sustainable offer status	Green Premium product
California proposition 65	WARNING: This product can expose you to chemicals including: Diisononyl phthalate (DINP), which is known to the State of California to cause cancer, and Di-isodecyl phthalate (DIDP), which is known to the State of California to cause birth defects or other reproductive harm. For more information go to <a href="http://www.P65Warnings.ca.gov">www.P65Warnings.ca.gov</a>
REACH Regulation	 <a href="#">REACH Declaration</a>
EU RoHS Directive	Pro-active compliance (Product out of EU RoHS legal scope)  <a href="#">EU RoHS Declaration</a>
Mercury free	Yes
RoHS exemption information	 Yes

---

Environmental Disclosure	<a href="#">Product Environmental Profile</a>
Circularity Profile	<a href="#">End Of Life Information</a>

---

### Contractual warranty

---

Warranty	18 months
----------	-----------

---

Dimensions

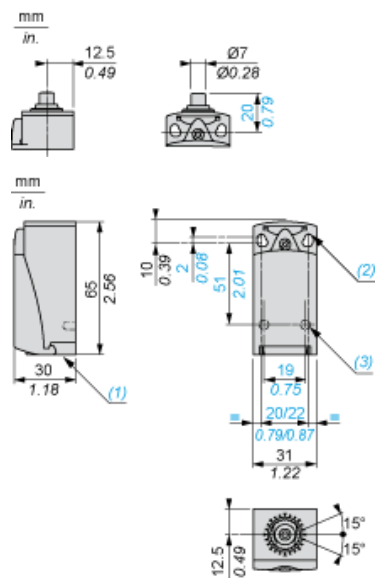

- (1) Tapped entry for Pg 11 cable gland
- (2) 2 elongated holes  $\text{Ø} 4.3 \times 6.3$  mm on 22 mm centres, 2 holes  $\text{Ø} 4.3$  on 20 mm centres.
- (3) 2 x  $\text{Ø} 3$  holes for support studs, depth 4 mm.

---

## Mounting with Cable Entry

---

### Position of Cable Gland

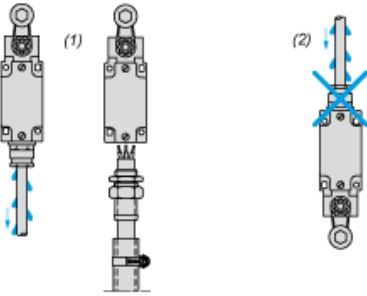

- (1) Recommended
- (2) To be avoided

---

## Setting-up

---

### Plunger or Multi-directional Heads

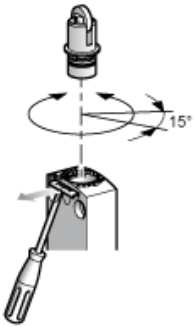

---

## Wiring Diagram

---

2-pole NC + NO Snap Action



Characteristics of Actuation

Switch Actuation on End

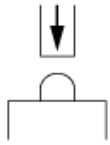

Functionnal Diagram

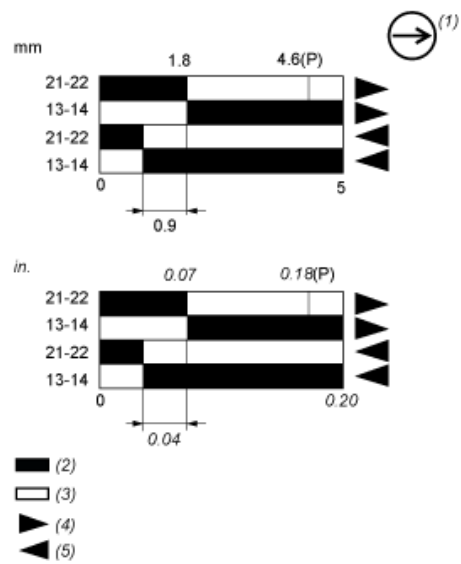

- (P) Positive opening point
- (1) NC contact with positive opening operation
- (2) Closed
- (3) Open
- (4) Tripping
- (5) Resetting