

IPS2200

Inductive Position Sensing

Description

The IPS2200 Inductive Position Sensing Starter Kit supports evaluation of the IDT IPS2200 IC via its application module, IPS2-COMBOARD and IPS2200 Eval-Kit software (GUI).

IPS2200 Evaluation Kit enables communication between user's computer (via GUI) and the IPS2200 IC. The user can send commands and data via computer's USB port to the IPS2-COMBOARD.

The microcontroller on the IPS2-COMBOARD interprets these commands and relays them to the IPS2200 using I2C or SPI communication interfaces.

The microcontroller also forwards data bytes from the IPS2200 back to the computer (GUI). These bytes can be analog signal readings, IPS2200 internal registers values, or IPS2200 EEPROM contents.

The IPS2200 Application Software is a graphical user interface (GUI) that is provided online for the kit. It supports all IPS2200 configurations and enables the user to understand the functionality of the IPS2200 as well as perform measurements.

Features

- USB “plug and play” – no driver installation needed
- Small IPS2-COMBOARD
- I2C and SPI communication interfaces enable quick and easy configuration and calibration of the IPS2200 using the user's computer
- High speed reading of the analog output signals.
- The modular design allows user to conveniently swap different IPS2200 Application Modules. IPS2-COMBOARD and IPS2200 Software (GUI) remains the same for different application modules.
- The kit software is available for download from the IDT product page for the IPS2-COMBOARD: www.IDT.com/IPS2-COMBOARD

Kit Contents

- IPS2-COMBOARD
- IPS2200MROT4x90001
- Micro-USB cable
- Two interface cables

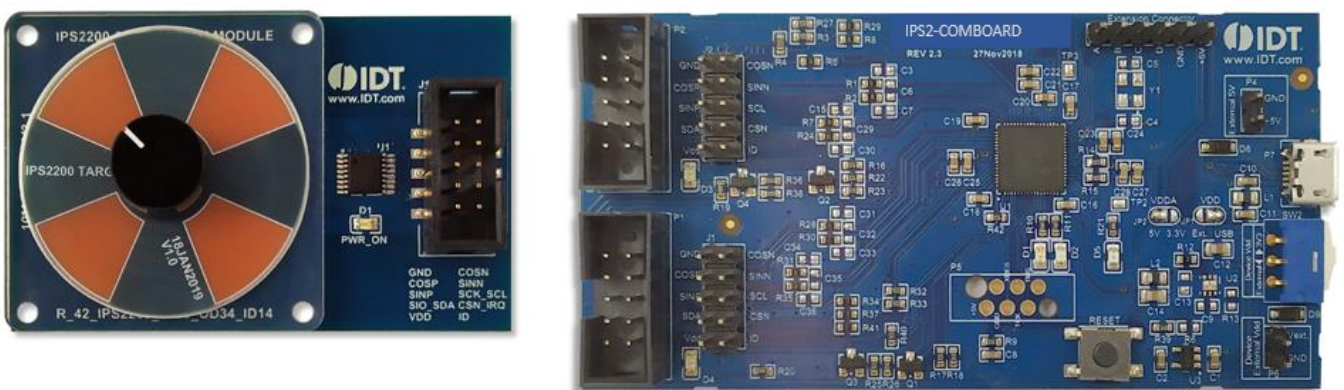

Figure 1. IPS2-COMBOARD and IPS2200MROT4x90001 Application Module

Important Notes

Disclaimer

Integrated Device Technology, Inc. and its affiliated companies (herein referred to as "IDT") shall not be liable for any damages arising out of defects resulting from

- (i) delivered hardware or software
- (ii) non-observance of instructions contained in this manual and in any other documentation provided to user, or
- (iii) misuse, abuse, use under abnormal conditions, or alteration by anyone other than IDT.

TO THE EXTENT PERMITTED BY LAW, IDT HEREBY EXPRESSLY DISCLAIMS AND USER EXPRESSLY WAIVES ANY AND ALL WARRANTIES, WHETHER EXPRESS, IMPLIED, OR STATUTORY, INCLUDING, WITHOUT LIMITATION, IMPLIED WARRANTIES OF MERCHANTABILITY AND OF FITNESS FOR A PARTICULAR PURPOSE, STATUTORY WARRANTY OF NON-INFRINGEMENT, AND ANY OTHER WARRANTY THAT MAY ARISE BY REASON OF USAGE OF TRADE, CUSTOM, OR COURSE OF DEALING.

Restrictions in Use

IDT's IPS2XXX Evaluation Kit, consisting of the IPS-COMBOARD and micro-USB cable used in combination with the IPS2XXX Application Module and the IPS2XXX AID EVKIT Application Software, is designed for evaluation and configuration of the IPS2XXX product family only. IDT's IPS2XXX Evaluation Kit hardware and software must not be used for characterization measurements in terms of replacing calibrated laboratory environment and measurement devices.



Important Safety Warning: These procedures can result in high currents, which can cause severe injury or death and/or equipment damage. Only trained professional staff should connect external equipment and operate the software.



Important Equipment Warning: Ensure the correct connection of all cables. Supplying the board using the wrong polarity could result in damage to the board and/or the equipment.

Contents

1. Setup	5
1.1 Required User Equipment	5
1.2 User Computer Requirements and Setup	5
1.2.1. Computer Requirements	5
1.2.2. Software Installation and Setup	5
1.3 Hardware Setup.....	5
1.3.1. Overview of the Hardware.....	5
1.3.2. Connecting the Kit.....	8
2. IPS2200 Eval Kit Software User Guide	9
2.1 Sections of the Display	9
2.2 Getting Started.....	10
2.2.1. Connecting to a Device	10
2.3 MAIN Tab.....	12
2.3.1. “Sensor Output Signals” Sub-Section	13
2.3.2. “Sensor Configuration” Sub-Section	16
2.4 CONFIGURE Tab.....	18
2.5 Calibration Wizard	19
2.5.1. TX Current Setup	20
2.5.2. Gain Stage Calibration	22
2.5.3. Offset Compensation	23
2.5.4. Mismatch Compensation.....	25
2.6 Working with the Memory	27
2.6.1. MEMORY EDIT Tab.....	27
2.6.2. Saving and Loading Memory Dump Files	27
3. Firmware Update	29
3.1.1. Automatic Firmware Update.....	29
3.1.2. Manual Firmware Update.....	29
4. IPS2-COMBOARD Schematics	31
5. IPS2-COMBOARD BOM	33
6. Sensors Board – IPS2200MROT4x90001	34
7. Glossary	34
8. Ordering Information	34
9. Revision History	34

Figures

Figure 1. IPS2-COMBOARD and IPS2200MROT4x90001 Application Module	1
Figure 2. IPS2200 Inductive Position Sensing Starter Kit Connections – IPS2200MROT4x90001	6
Figure 3. IPS2-COMBOARD – Overview	6
Figure 4. IPS2200MROT4x90001 Application Module – Overview.....	7
Figure 5. IPS2200 GUI	9
Figure 6. Start-Up Screen.....	11
Figure 7. Connected to a Single Device	11
Figure 8. Connected to Two Devices	12
Figure 9. MAIN Tab of GUI	12
Figure 10. "Sensor Output Signals" Sub-Section of the "MAIN" Tab	14
Figure 11. "Sensor Output Signals" Sub-Section Measuring in "Trigger Mode"	15
Figure 12. "Sensor Output Signals" Sub-Section Measuring in "Scrolling Mode"	16
Figure 13. "Sensor Configuration" Sub-Section.....	16
Figure 14. IPS2200 Block Diagram	17
Figure 15. "CONFIGURE" Tab	18
Figure 16. "I/O FUNCTIONS" Section	19
Figure 17. Calibration Wizard Window - Initial State	20
Figure 18. "TX Current Setup" Window	21
Figure 19. "Gain Stage Calibration" Window	22
Figure 20. "Offset Compensation" Window	24
Figure 21. "Mismatch Compensation" Window	25
Figure 22. "MEMORY EDIT" Tab Contents – IPS2200 Example	27
Figure 23. Menu Options for Saving and Loading Memory Dump Files	28
Figure 24. Automatic Firmware Update Message Box	29
Figure 25. Manual Firmware Update Menu Option	30
Figure 26. Manual Firmware Update Dialog Window	30

Tables

Table 1. IPS2-COMMBOARD Key Components and Connector Descriptions	7
Table 2. IPS2200MROT4x90001 Application Module: Key Components and Connector Descriptions	7
Table 3. Bill of Materials for IPS2-COMBOARD Rev. 2.3	33

1. Setup

1.1 Required User Equipment

A Windows®-based computer is required for interfacing with the kit and configuring the IPS2200.

1.2 User Computer Requirements and Setup

1.2.1. Computer Requirements

The user must have administrative rights on the computer to download and install the *IPS2200 Eval Kit Software*.

The computer must meet the following requirements:

- Windows® Vista SP1 or later, 7 (including SP1), 8, 8.1, or 10.
Note: Touch screens are not supported.
Note: Windows® XP is not supported. Contact IDT for assistance, see contact information on the last page.
- Supported architecture: x86 and x64.
- Available USB port.
- Internet access for downloading the *IPS2200 Eval Kit Software*.
- Microsoft® .NET Framework 4.0

1.2.2. Software Installation and Setup

The *IPS2200 Inductive Position Sensing Eval Kit Software* is not included with the kit. To ensure use of the latest version of the software, it is available for download free of cost in zip file format from the IDT web site on the web page given on page 1.

Follow these procedures to install the *IPS2200 Inductive Position Sensing Eval Kit Software*:

1. Download and extract the zip file to the user's computer.
2. Double-click on the extracted setup.exe file to activate the installation.
3. Follow the standard installation instructions displayed on the screen.
Change the installation path if required: if the default path settings have been used, the software automatically completes the installation and creates an access link on the user's computer under *Start > All Programs > IDT > IPS2200 EVKIT*.
The installation dialog offers the option to create a desktop short-cut icon for the software.

1.3 Hardware Setup

This section describes the basic hardware setup of the IPS2200 Inductive Position Sensing Starter Kit. It provides a brief overview of the system's components.

1.3.1. Overview of the Hardware

Figure 2 shows the board connections for the IPS2200 Evaluation Kit using the IPS2200MROT4x90001 Application Module as an example.

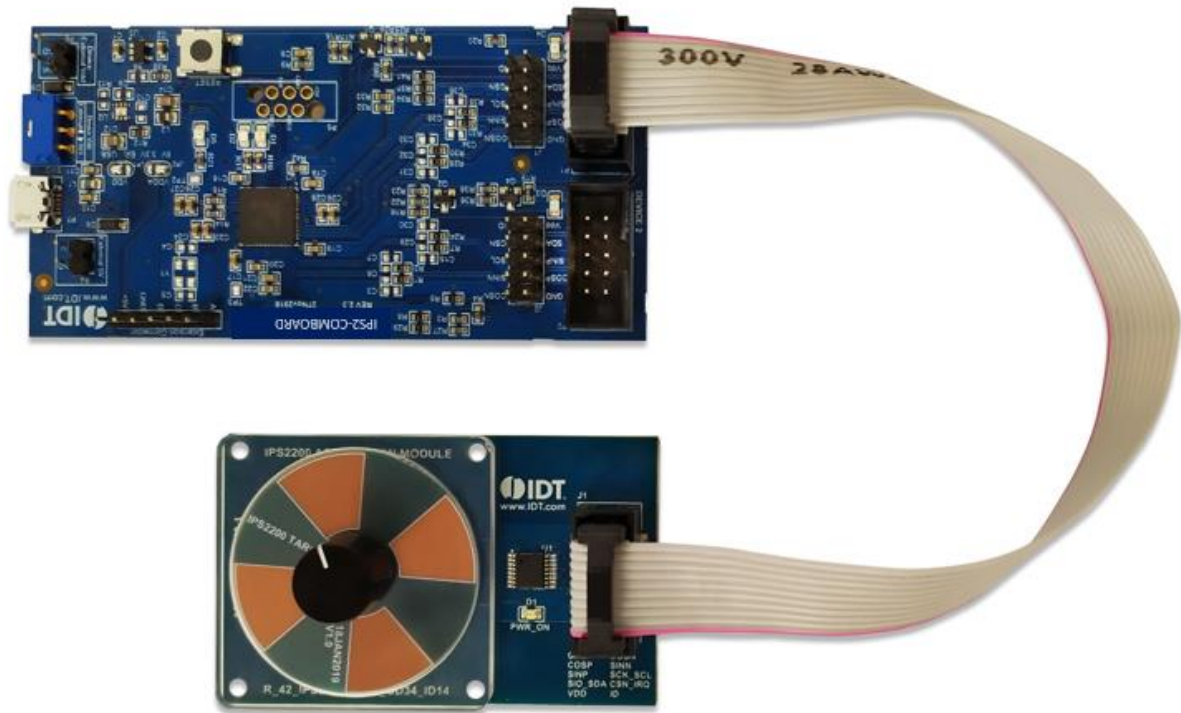

Figure 2. IPS2200 Inductive Position Sensing Starter Kit Connections – IPS2200MROT4x90001 Application Module Example

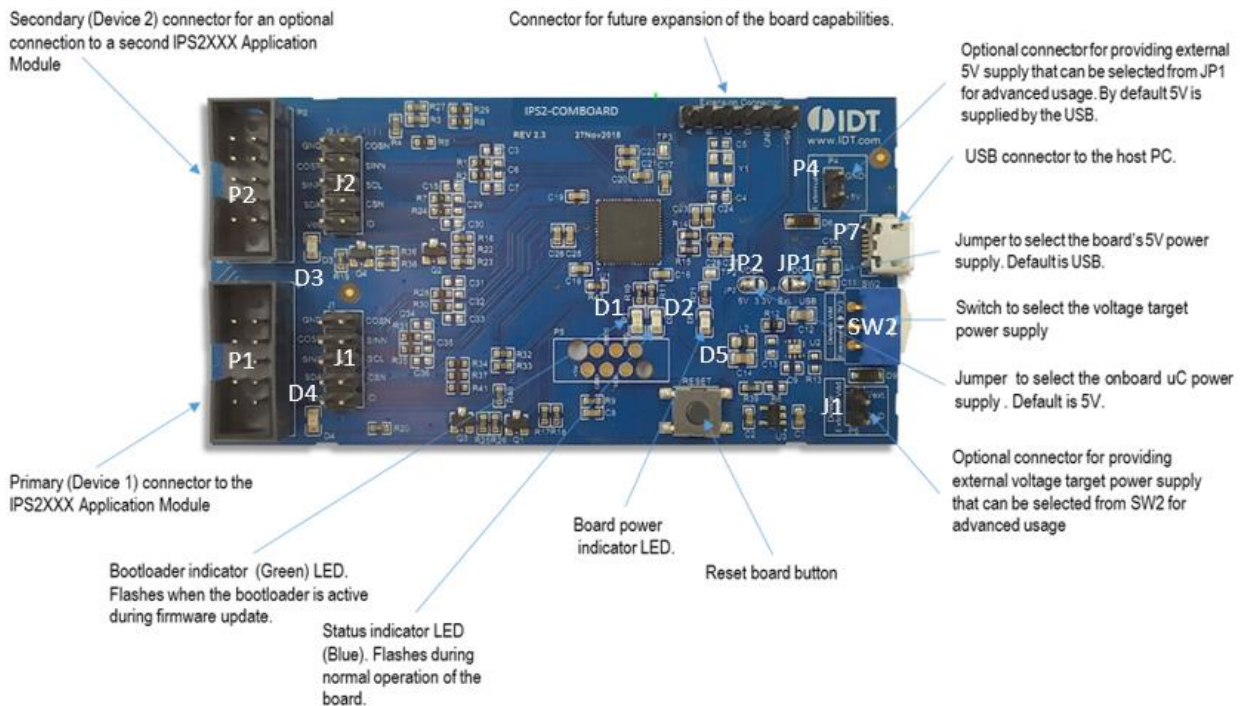

Figure 3. IPS2-COMBOARD – Overview

Table 1. IPS2-COMMBOARD Key Components and Connector Descriptions

Label	Description
P1	Primary (Device 1) connector to the IPS2200 Application Module Sensor Board.
J1	Alternative connector to the primary IPS2200 Application Module Sensor Board.
P2	Secondary (Device 2) connector for an optional connection to a second IPS2200 Application Module Sensor Board. If connecting to two modules at the same time, the IPS2200 ICs on the modules must have the same power supply option.
J2	Alternative connector to the secondary IPS2200 Application Module Sensor Board.
Extension Connector	Connector for future expansion of the board capabilities.
P4	Optional connector for providing external 5V supply that can be selected from JP1 for advanced usage. By default 5V is supplied by the USB.
P5	Debug connector.
P6	Optional connector for providing external voltage target power supply that can be selected from SW2 for advanced usage. By default supplies are provided from the IPS2-COMMBOARD.
P7	USB connector to the host PC.
SW2	Switch to select the voltage target power supply. Position 1 uses internal 3.3V, position 2 uses external target VDD provided on P6.
RESET	Reset board button.
D1	Bootloader indicator (Green) LED. Flashes when the bootloader is active during firmware update.
D2	Status indicator LED (Blue). Flashes during normal operation of the board.
D3	Secondary module (Device 2) power indicator LED (Red).
D4	Primary module (Device 1) power indicator LED (Red).
D5	Board power indicator LED (Red).
JP1	Jumper to select the board's 5V power supply. Default is USB.
JP2	Jumper to select the onboard uC power supply. Default is 5V.

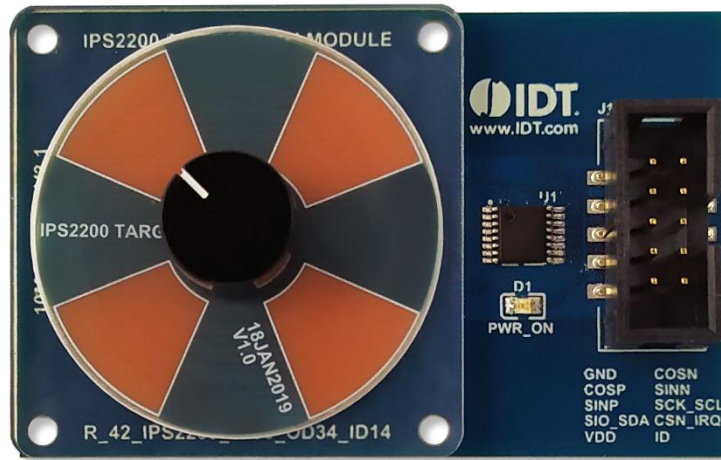

Figure 4. IPS2200MROT4x90001 Application Module – Overview

Table 2. IPS2200MROT4x90001 Application Module: Key Components and Connector Descriptions

Label	Description
J1	Header for cable to the IPS2-COMBOARD.
D1	Power Indicator LED for the VDD.

1.3.2. Connecting the Kit



Important Equipment Warning: Ensure the correct connection of all cables. Supplying the board using the wrong polarity could result in damage to the board and/or the equipment.

1. Ensure that the IPS2-COMBOARD is not connected to the computer.
2. Assemble the IPS2200 Application Module with the target holder as described in the user manual for the specific application module.
3. Connect the IPS2200 Application Module via the flat cable to the IPS2-COMBOARD as shown in Figure 2.
4. Connect the IPS2-COMBOARD to the computer using the micro-USB cable provided in the IPS2-COMBOARD.
Power is provided from the computer via the USB connection. No external power source is required.
5. The indicator D5 on the IPS2-COMBOARD will light (see Figure 3) if conditions are normal. This indicates that the board is ready to communicate with the IPS2200 EVKIT Application Software. The D1 LED on the IPS2200 Application Module (see Figure 4) also lights when the board is powered on.

2. IPS2200 Eval Kit Software User Guide

2.1 Sections of the Display

The *IPS2200 Eval Kit Software* provides a graphic user interface (GUI) for communicating with the kit. The GUI is displayed when the application is started, see Figure 5 for details.

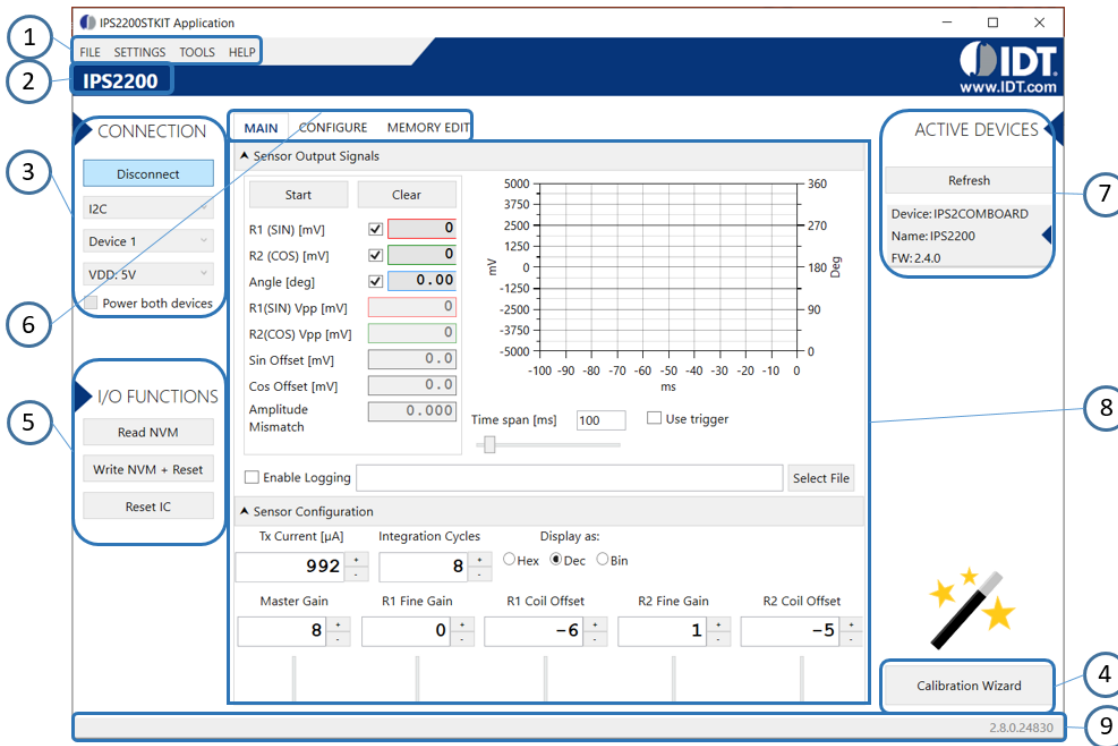

- 1 Menu bar: Contains settings and tools.
- 2 Information label: Displays the name of the connected device.
- 3 “CONNECTION” section: Displays connection-related options.
- 4 “Calibration Wizard” button: Displays a calibration wizard window to calibrate the device.
- 5 “I/O FUNCTIONS” section: Displays options to perform READ and WRITE actions on the connected device.
- 6 Navigation tabs: Used to switch between the different main window tabs.
- 7 “ACTIVE DEVICES” section: Displays a list of the currently connected communication boards.
- 8 Main window area: Displays options and information about the connected device.
- 9 Status bar: Displays status messages during operation.

Figure 5. IPS2200 GUI

2.2 Getting Started

The following steps describe how to establish a connection to the IPS2200 Application Module and perform measurements. The combination of an IPS2-COMBOARD and its connected IPS2200 Application Module is referred to as the “device” in the GUI.

2.2.1. Connecting to a Device

1. Ensure that the IPS2200 Application Module is properly connected to the IPS2-COMBOARD, see section 1.3.2.
2. Connect the IPS2-COMBOARD to the user’s computer using the micro-USB cable provided in the kit.
3. Start the GUI application, see Figure 6 for the start-up screen.
The device appears in the “ACTIVE DEVICES” section.
4. Select the device from the “ACTIVE DEVICES” section.
If there are no other devices on the list, it is automatically selected.
If the device shows as unknown, do either of the following:
 - Click on the “Refresh” button in the “ACTIVE DEVICES” section. This will automatically identify it.
 - Device could also be manually identified. For a description of how to manually identify a device, refer to section 1.

The GUI automatically checks the firmware version of the device; if an update necessary, it displays a message.

5. Select the correct communication protocol (I2C or SPI) from the “CONNECTION” section. This should match the protocol supported by the IPS2200 on the application module.
6. Select the device connector on the IPS2-COMMBOARD to which the application module is connected.
7. Select the correct power supply setting that matches the VDD configured in the IPS2200 on the application module.
By enabling “Power both devices”, two sensor boards can also be connected to the IPS2-COMBOARD at the same time; see Figure 8 for an example. Analog data is displayed from both devices. Communication is initiated only with the device selected through the drop down menu on the top left side (Device 1 or Device 2). Note: When connecting to two modules at the same time, both IPS2200 ICs on the modules must have the same VDD option.
8. Click on the “Connect” button.
After a successful connection, the GUI displays the contents of the main window area, see Figure 9.

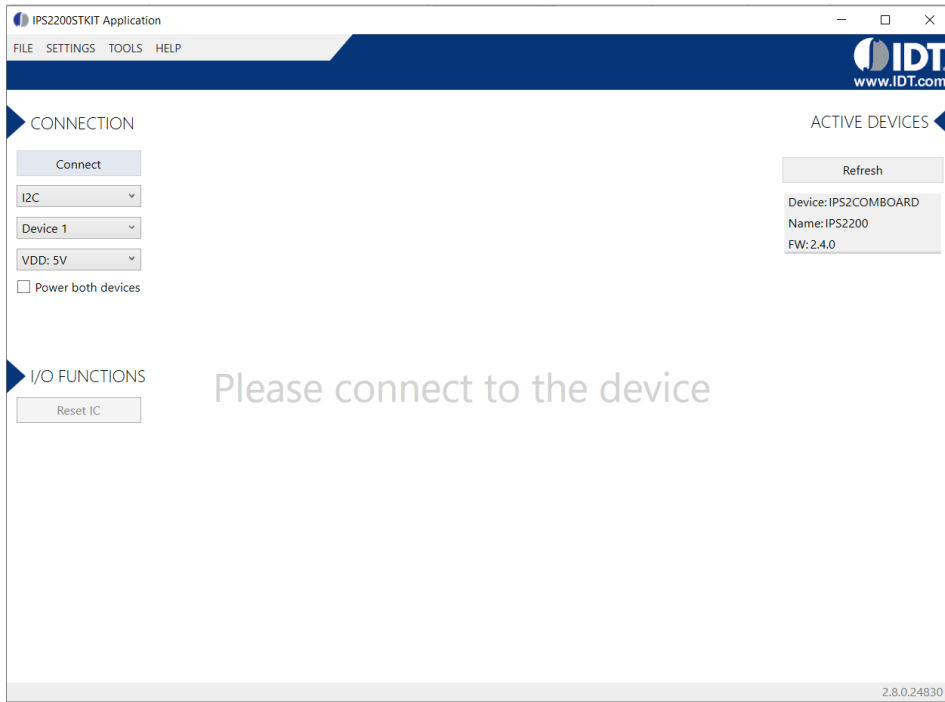

Figure 6. Start-Up Screen

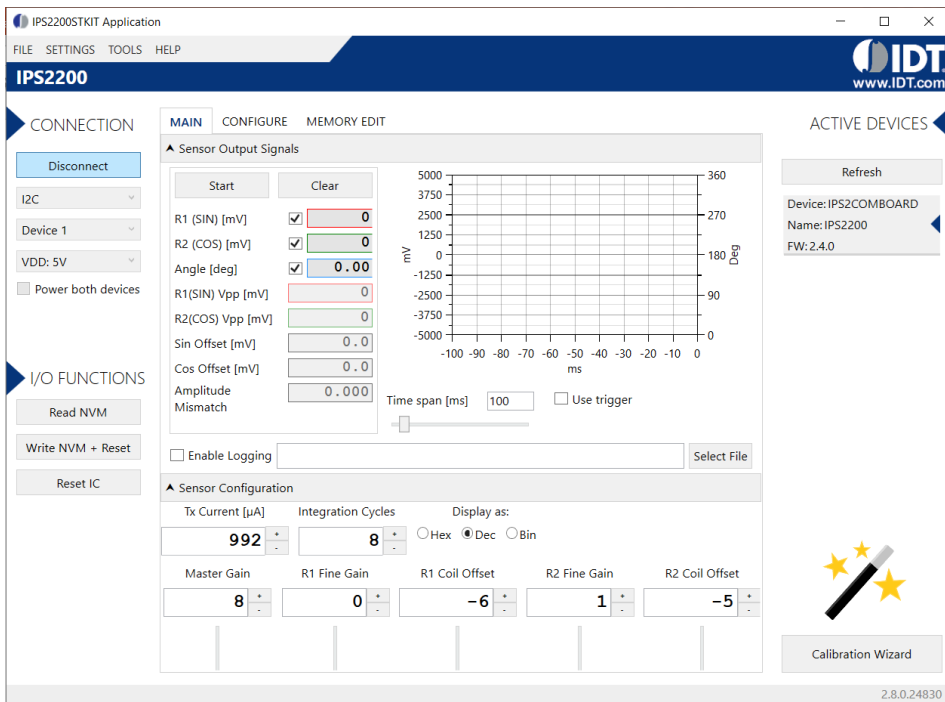

Figure 7. Connected to a Single Device

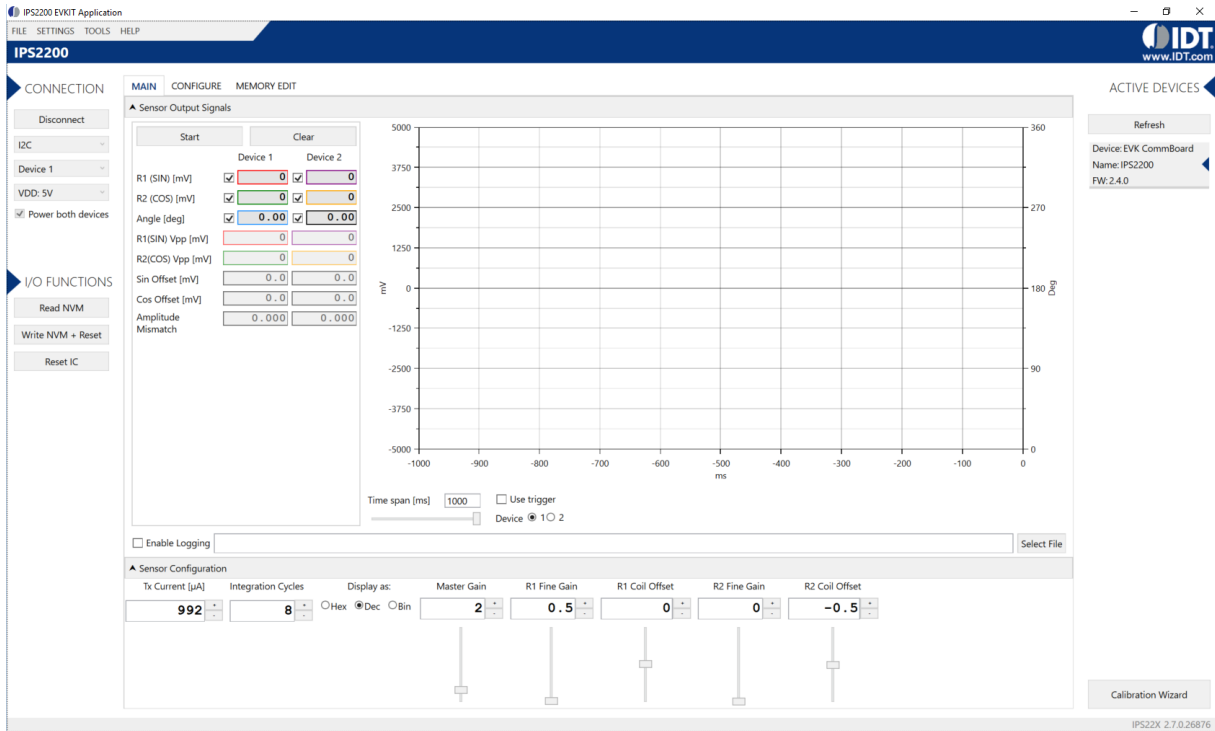

Figure 8. Connected to Two Devices

2.3 MAIN Tab

The “MAIN” tab is available from the navigation menu when a device is connected, see Figure 9.

The “Sensor Output Signals” and “Sensor Configuration” sub-sections can be visually collapsed or expanded to allocate more screen space to the other sub-section.

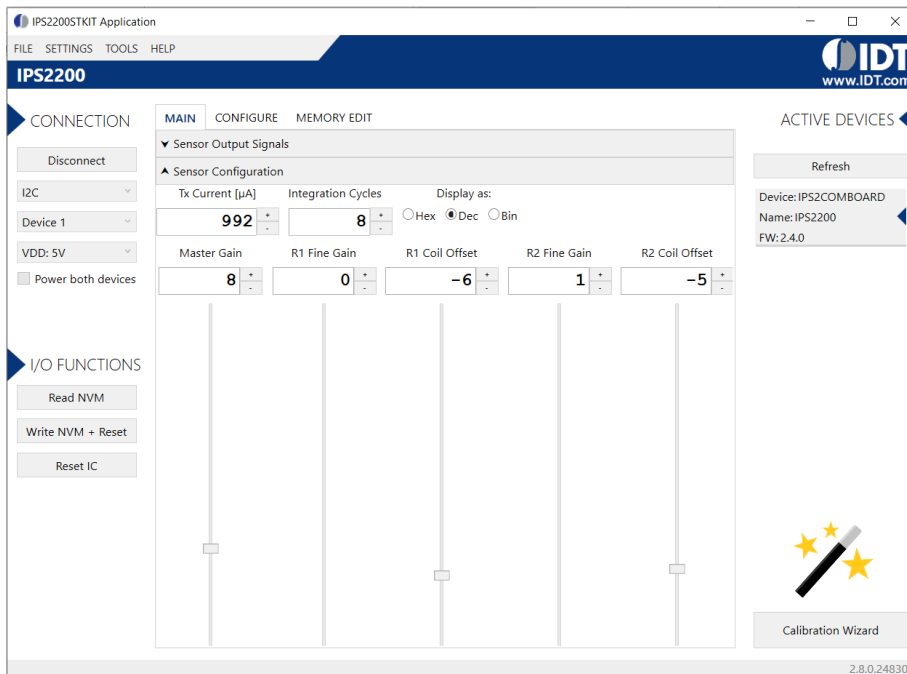

Figure 9. MAIN Tab of GUI

2.3.1. “Sensor Output Signals” Sub-Section

The “Sensor Output Signals” sub-section is used to measure and visualize data from the output signals of the IPS2200. It displays the physical output values captured using two 12-bit Successive Approximation Analog-to-Digital converters by the microcontroller located on the IPS2-COMBOARD. Therefore, the accuracy of the measured values is limited due to the setup. The IPS Evaluation Kit is a configuration tool – it is not intended to act as a measurement device.

The “Sensor Output Signals” sub-section (see Figure 10) has the following elements:

- “Start/Stop” button – Starts and Stops the measurement. Starting the measurement cycle makes some of the GUI elements inactive until it is stopped. Alternatively changing to another tab, disconnecting from the IPS2200 or encountering a communication error stops the measurement cycle.
- “Clear” button – Clears the values in the measurement text boxes and graphs.
- “R1 (SIN)” and “R2 (COS)” textboxes – Display the latest output signal measurement in mV when in Scrolling Mode. Textbox border colors correspond to the colors of the signal traces on the graph:
 - Sine: red
 - Cosine: green
 - Angle: blue

The signal trace graphs can be enabled or disabled from the check boxes located on the left side of the textboxes.

- “Angle [deg]” textbox - Displays the latest calculated position based on R1 and R2 in degrees when in Scrolling Mode. Textbox border color corresponds to the color of the signal trace on the graph. The signal trace on the graph can be enabled or disabled from the check box located on the left side of the textbox.
- “R1(SIN) Vpp [mV]” and “R2(COS) Vpp [mV]” textboxes – Display the peak-to-peak voltage values of the sine and cosine signals in mV when in Trigger Mode. Only the data that is currently displayed on the graph is used for the peak-to-peak calculation. Textbox border colors correspond to the colors of the signal traces on the graph.
- “Sin Offset [mV]” and “Cos Offset [mV]” textboxes – Display the offset of sine and cosine signals with respect to 0V (center) line in mV when in Trigger Mode. Only the data that is currently displayed on the graph is used for the offset calculation.
- “Amplitude Mismatch” textbox – Displays the amplitude mismatch between peak-to-peak voltage values of the sine and cosine signals in Trigger Mode. Calculation formula is

$$\text{Mismatch} = R1 V_{pp} / R2 V_{pp}$$
 Only the data that is currently displayed on the graph is used for the mismatch calculation.
- “Time span [ms]” textbox and slider – Horizontal time span of the graph in ms when in Scrolling Mode. It is configurable between 10ms and 1000ms by the user.
- “Periods” textbox and slider – Horizontal time span of the graph when in Trigger Mode. The timespan of the graph is calculated according to the requested number of full electrical periods of sine and cosine signals. For example; 4 periods display full 4 electrical periods of sine and cosine signals on the graph. The graph adjusts the timespan to fit 4 electrical periods of output signals. The value can be configured between 1 and 10 by the user.
- “Use trigger” checkbox – Selects between the two operational modes of the measuring cycle: Trigger Mode when checked and Scrolling Mode when unchecked.
- “Operation range” combo box – Specifies whether to draw dotted horizontal lines on the graph at the maximum operational range of the output. The operational range lines are updated on the graph only when the measurement cycle is running.
- Logging section – To enable logging, check the “Enable Logging” checkbox. Specify a valid log file location by either using the “Select File” button or typing a file location manually in the textbox. If there is not a file with the specified file name, it is created when the measurement cycle starts. If a file already exists, a new log session containing the data will be appended to it. In Scrolling Mode, output

signals and calculated positions are logged. In Trigger Mode only peak-to-peak, offset and mismatch values are recorded. The internal data structure of the log file is CSV (Comma Delimited Values).

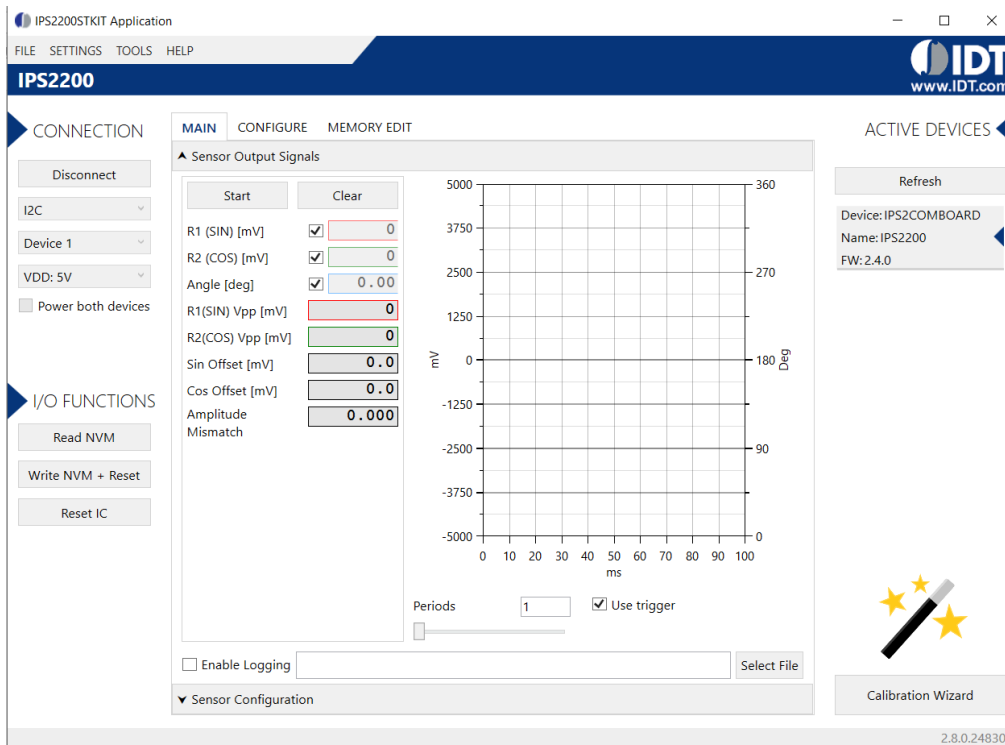
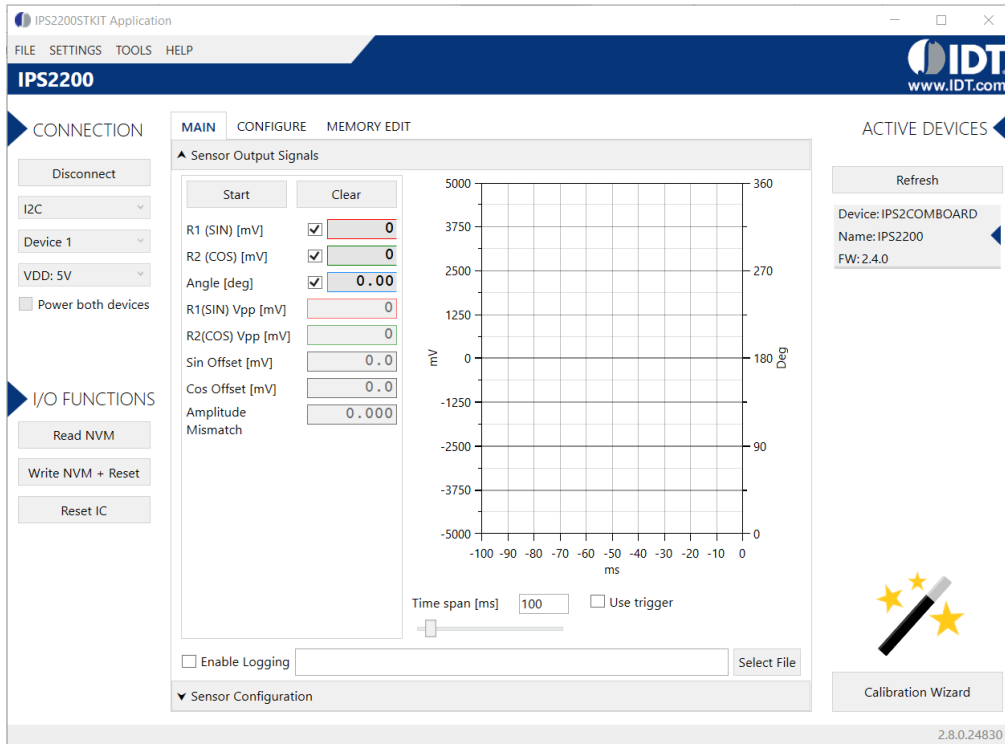

Figure 10. "Sensor Output Signals" Sub-Section of the "MAIN" Tab

2.3.1.1. Trigger Mode

Output data is sampled at a constant high-speed rate and displayed on the graph as electrical periods (see Figure 11). The start of the sampling period is triggered by the zero-crossing of the rising front of the R1 (SIN) signal. Peak-to-peak, offset and mismatch values are calculated from the signals on the graph and displayed in the textboxes.

Clicking the “Start” button activates the measurement cycle. The target must be rotating at a constant speed before starting the measurement cycle. Initially, the measurement cycle detects the length of the electrical period of the output signals, and then the graph starts to update repeatedly with new sampled output data. Click the “Stop” button to stop the measurement cycle.

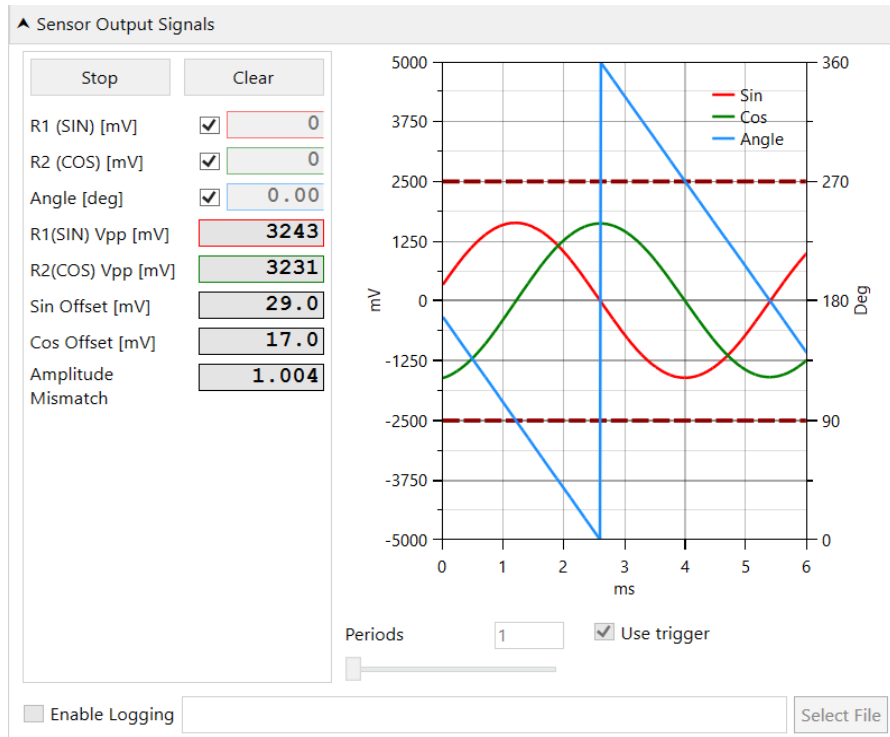

Figure 11. "Sensor Output Signals" Sub-Section Measuring in "Trigger Mode"

2.3.1.2. Scrolling (Non-Trigger) Mode

Output data is continuously sampled at a slower rate and displayed on a scrolling graph (see Figure 12). Only the latest measurements are shown in the “R1 (SIN)”, “R2 (COS)”, and “Angle [deg]” textboxes. The target can be stationary or rotated slowly by hand. This mode is not recommended for targets that rotate at high speeds because of its slow and inconsistent sampling rate.

Clicking the “Start” button activates the measurement cycle. Click the “Stop” button to stop the measurement cycle.

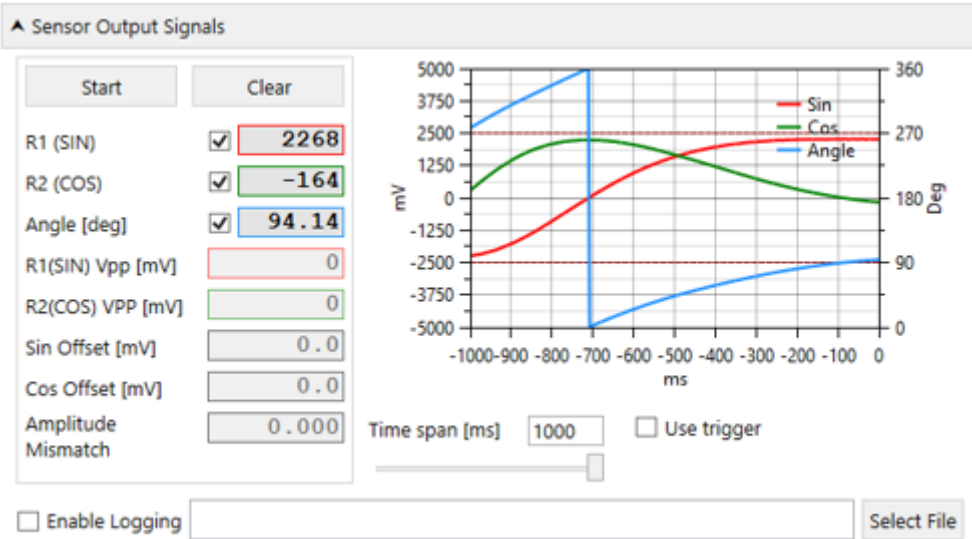

Figure 12. "Sensor Output Signals" Sub-Section Measuring in "Scrolling Mode"

2.3.2. "Sensor Configuration" Sub-Section

The "Sensor Configuration" sub-section allows the user to modify configuration registers. This section enables user to manually calibrate IPS2200 module. The values can be modified while the "Sensor Output Signals" sub-section is continuously measuring the output. Effects of the new configuration is displayed in real time.

The values can be modified by entering newer values in the text boxes, moving the sliders, or clicking on +/- buttons. Tool selects the closest register value if the newer value does not have an exact match.

For automatic calibration see section 2.5.

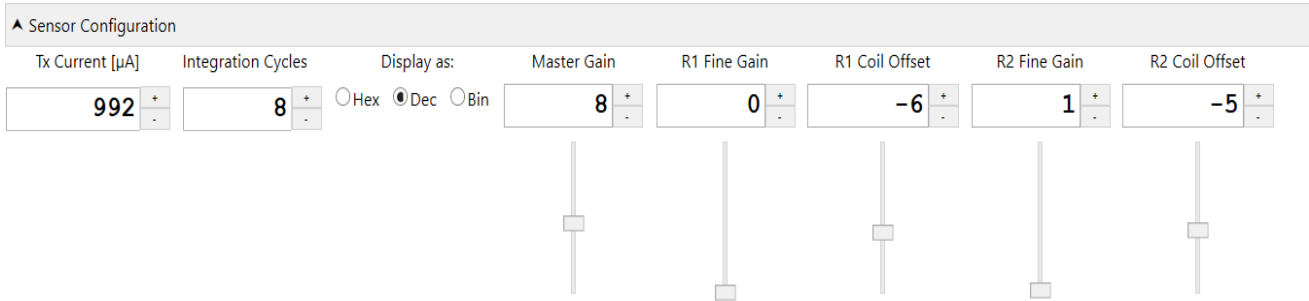

Figure 13. "Sensor Configuration" Sub-Section

The following parameters can be set on the device:

- Tx Current [µA]
 - LC oscillator bias current. Due to different coil architectures, the bias current need to be adjusted by a 5-bit programmable parameter to optimize the sensor performance. Higher bias current enables the system to have stronger signal levels although the power consumption also increases. This parameter can be set with register 0x07 (in NVM).
 - $I_{BIAS} = VDD / (35 \times L \times Q \times F_{EXC})$

Where;

VDD = Supply voltage in volts

L = Inductance of transmit coil in Henry

Q = Quality factor; refer to the *IPS2200 Datasheet*

F = Transmit oscillator frequency in MHz

- Integration Cycles
 Defines the number of integration cycles (5 to 31, programmable). The lowest number (5) of integration cycles provide the fastest output response, the highest number (31) of integration cycles provide a better filtered output response. This parameter can be set in register 0x02 (in NVM), see the *IPS2200 Datasheet* for a details.
- Display as:
 - Hex: displays the exact bit-field value that is written to the IPS2200 internal registers
 - Dec: displays the data as interpretation of the bit-field values according to the IPS2200 documentation
 - Bin: displays the exact bit-field value that is written to the IPS2200 internal registers
- Master Gain
 Defines the main gain of both internal programmable amplifiers (channel R1 and R2). This parameter can be set with register 0x02 (in NVM).
- R1 Fine Gain
 Defines the fine gain of the internal programmable amplifier for channel R1. Used to minimize the amplitude mismatch between the two receiver amplifiers. This parameter can be set with register 0x12 (in NVM).
- R1 Coil Offset
 Defines the correction of R1 coil offset at the receiver coil input R1P/R1N. This parameter can be set with register 0x06 (in NVM).
- R2 Fine Gain
 Defines the fine gain of the internal programmable amplifier for channel R2. Used to minimize the amplitude mismatch between the two receiver amplifiers. This parameter can be set with register 0x13 (in NVM).
- R2 Coil Offset
 Defines the correction of R2 coil offset at the receiver coil input R2P/R2N. This parameter can be set with register 0x04 (in NVM).

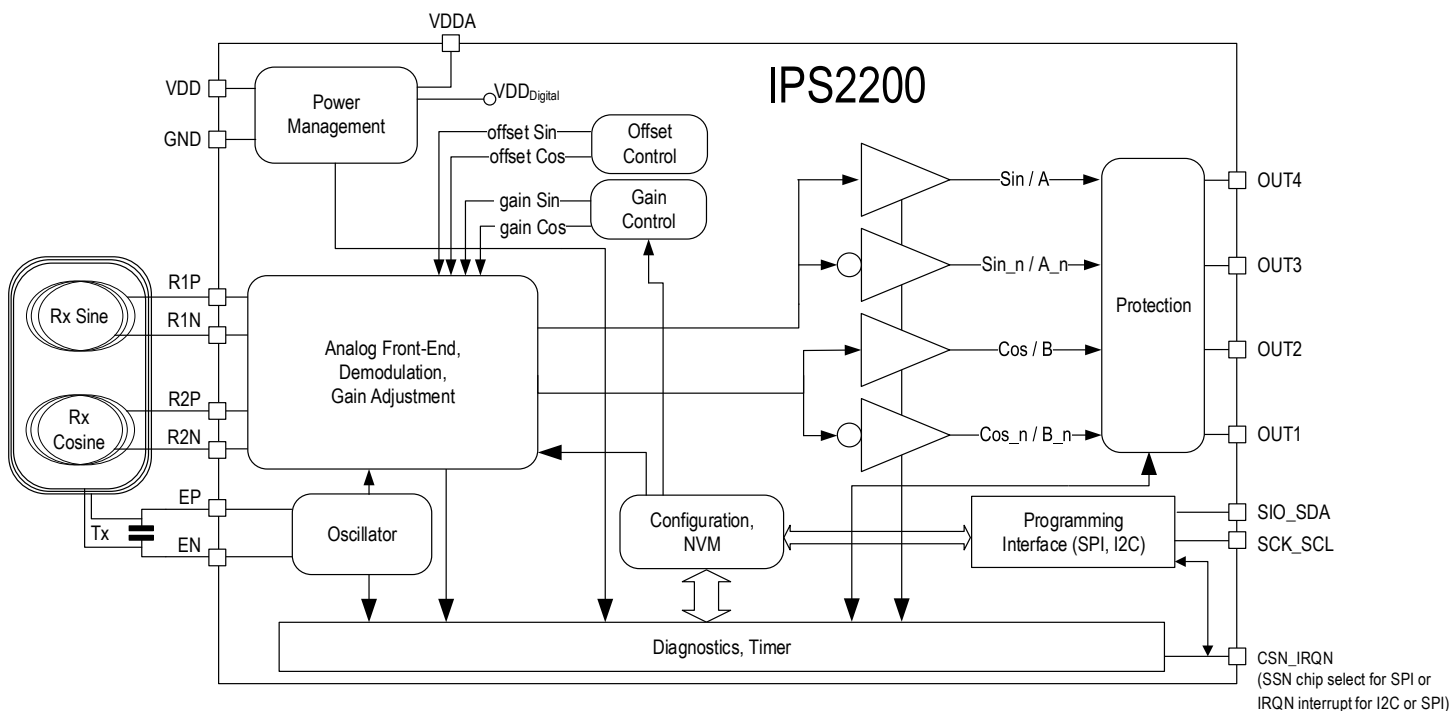

Figure 14. IPS2200 Block Diagram

2.4 CONFIGURE Tab

On the “CONFIGURE” tab (see Figure 15), each value represents a register or a part of a register from the internal memory of the device. The displayed memory type can either be NVM, SRB or SFR memory. SRB refers to shadow registers which are used as the working memory for the IPS2200, and they can temporarily be written to IPS2200 via GUI during development. SFR refers to special function registers which are mostly used for diagnostics.

Each memory type has a corresponding “Read” and “Write” button in the “I/O FUNCTIONS” section on the left side bar of the GUI:

- Read: reads the contents of the corresponding memory
- Write: applies the changes displayed on the GUI to the corresponding memory location on the IPS2200. If a value is changed on the GUI, the font color changes to red (see Figure 20) indicating that it is not applied to the actual memory (NVM/SRB/SFR) of the IC.

Note: If the NVM memory parameters are changed, the IPS2XXX is automatically reset (power cycled) by the “Write NVM + Reset” button, see Figure 16. The device can also be power cycled by the “Reset IC” button. After reset, the contents of the NVM of the device are copied to its working memory SRB.

If numerical values on the CONFIGURE tab are hexadecimal, “0x” is automatically inserted at the beginning of the value, otherwise the values are displayed in decimal format.

Place the cursor over an element on the screen for a brief description of the setting and the address of the internal memory register.

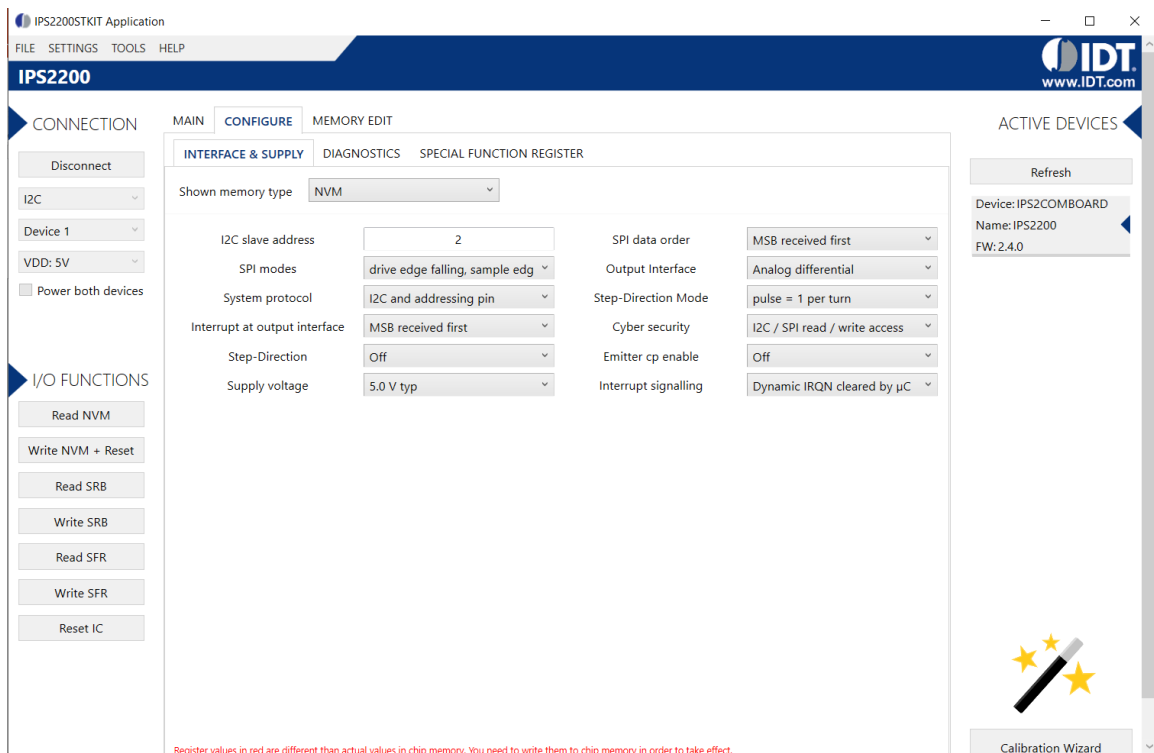

Figure 15. "CONFIGURE" Tab



Figure 16. "I/O FUNCTIONS" Section

2.5 Calibration Wizard

The Calibration Wizard is an automatic method of configuring IPS2200's TX bias current, offset compensation, gain, and amplitude mismatch of output signals. Rotate the target at a constant speed of 100 rpm to 1000 rpm before automatic calibration is launched.

Process can be started by pressing the "Calibration Wizard" button on the MAIN tab (see Figure 5). The button is available only when the GUI is connected to IPS2200. The MAIN tab is inactive when the "IPS2200 Calibration Wizard" window is open.

Calibration process can be started by clicking on each of the four calibration parameter buttons. This can be done as shown in sequence below or arbitrarily.



After each parameter is calibrated, move on to the next step by clicking "proceed button".

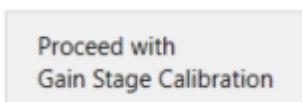

When all calibration steps are completed, write the new calibration data to the NVM of IPS2200 by clicking the "Write Calibration to NVM" button.

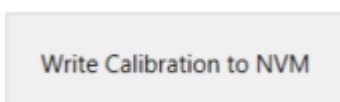

Standard Calibration Sequence:

1. TX Current Setup – Calculate the transmitter bias current based on specified coil parameters, see section 2.5.1 for details. It optimizes coil performance.
2. Gain Stage Calibration – Calibrate the Master Gain registers, see section 2.5.2 for details. It puts the receive signals within an optimal range.
3. Offset Compensation – Calibrate the individual Coil Offset registers, see section 2.5.3 for details. It reduces offset.
4. Mismatch Compensation – Calibrate the individual Fine Gain registers, see section 2.5.4 for details. It equalizes the mismatch between the amplitude of the output signals.

The calibration steps can also be performed individually. User can select the specific parameter and calibrate it without having to calibrate all. The new calibration data can be written to the NVM of IPS2200 at any point by clicking the “Write Calibration to NVM” button.

Upon closing the calibration window, the wizard will suggest to write unsaved calibration data to the NVM of the IPS2200.

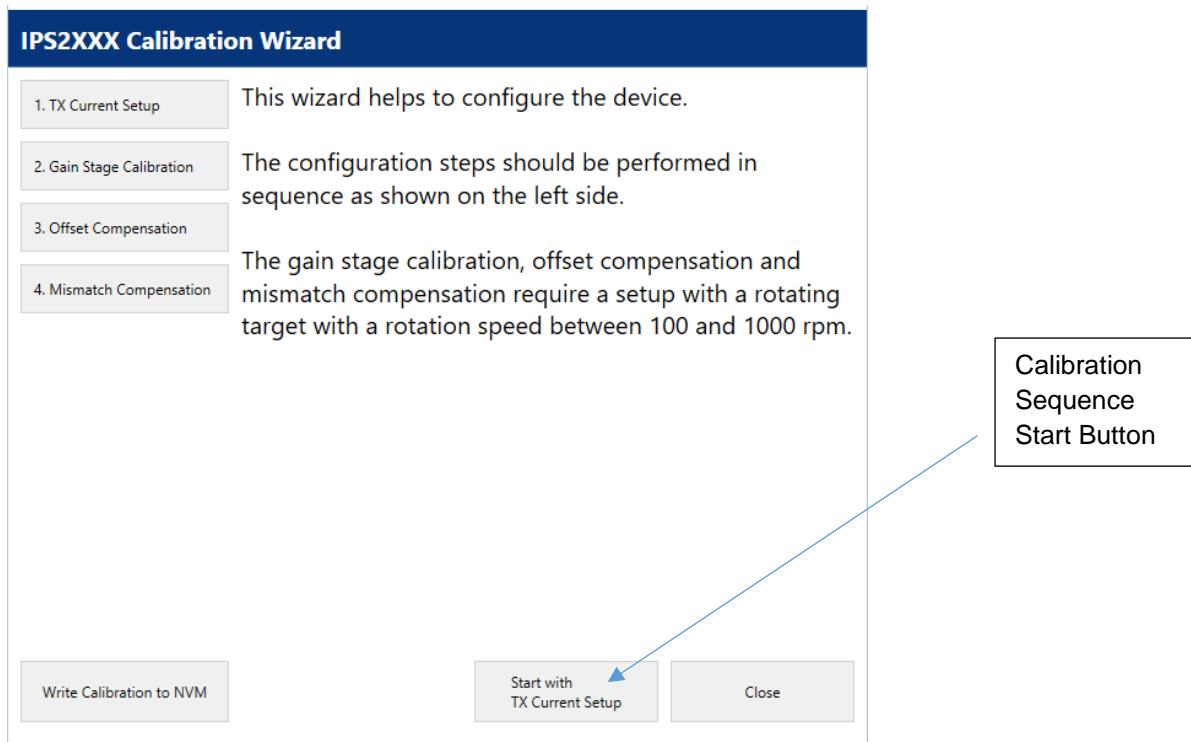

Figure 17. Calibration Wizard Window - Initial State

2.5.1. TX Current Setup

The “TX Current Setup” calibration is used for configuring the bias current of the transmit coil. It can be directly triggered by “1. TX Current Setup” button or by clicking “Start with TX Current Setup” when the Wizard is in its initial state after the launch.

Figure 18. “TX Current Setup” Window

Calibrate the “TX Current Setup” by performing the following steps:

1. Specify the three input values:
 - a. L [µH] – The Coil Inductance in µH
 - b. Q – The Quality Factor of the LC tank

$$Q_p = \frac{R'}{\omega_r L} = R' \sqrt{\frac{C}{L}}$$

Where

Q_p Quality factor of a parallel resonator circuit

R' Equivalent parallel resistor

ω_rL Coil reactance at resonance frequency

C Capacitance of parallel capacitor C

L_{COIL} Inductance of the printed circuit Tx coil

- c. Fexc [MHz] – The excitation frequency in MHz
2. Click the “Calculate TX Current” button.
The tool calculates the I_{bias} current based on the specified formula and then finds the closest available value that can be written in the TX current register. The calculated register values are immediately written to the SRB and prepared to be written to the NVM.
3. If the new calibration data needs to be written to the NVM of IPS2200, click the “Write Calibration to NVM” button.
Alternatively, the Wizard prompts the user to write the new calibration data to NVM when the calibration sequence is complete or when the Wizard window is closing.

The “VDD”, “System Type” and “Formula” fields are not editable in the Calibration Wizard. The “VDD” and “System Type” settings are copied from the “CONNECTION” section of the MAIN tab (see Figure 5), the Formula is calculated based on the System Type selected.

- VDD – The supply voltage of the IPS2200, it can be 3.3V or 5V.
- System Type – Single or Redundant, depending on whether the “Power both devices” option is set, see Figure 5.
- Formula – Depending on the System Type, the calculation can be:
 - $I_{bias} = VDD / (35 \times L \times Q \times F_{exc})$ for Single TX Coil System Type
 - $I_{bias} = VDD / (50 \times L \times Q \times F_{exc})$ for Redundant System Type (2 TX coils)

2.5.2. Gain Stage Calibration

The “Gain Stage Calibration” is used for configuring the Master Gain register for the two output signals. Peak-to-peak voltages of the two output signals are measured. Values that put the two output signals in an optimal signal range are automatically calculated.

Note: The target needs to be rotating at a constant speed between 100 rpm and 1000 rpm while performing this step.

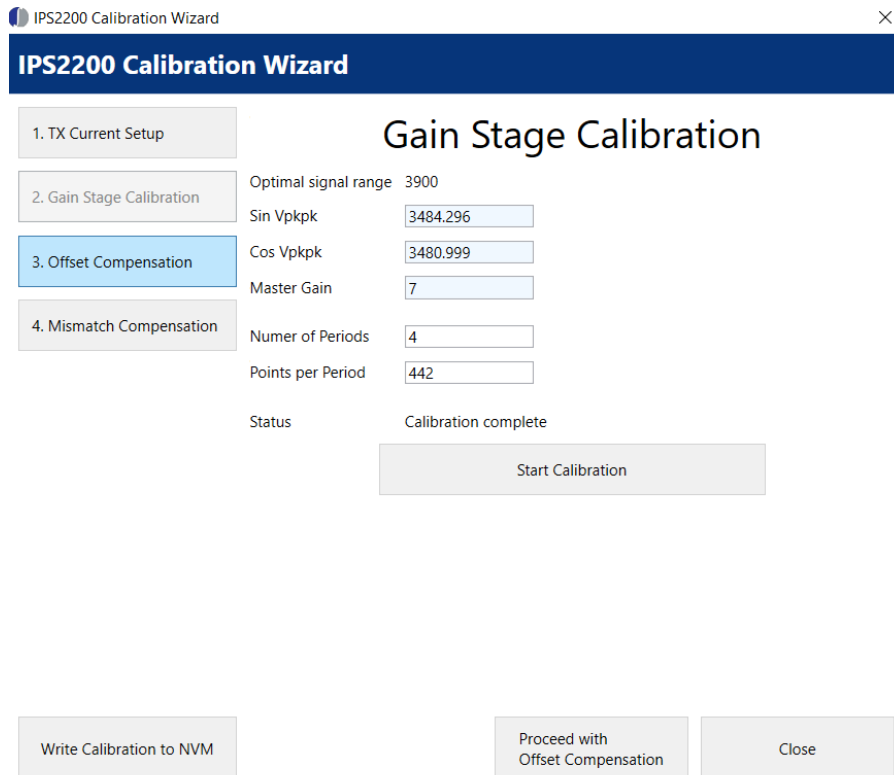

Figure 19. “Gain Stage Calibration” Window

Calibrate the “Gain Stage Calibration” by performing the following steps:

1. Specify the two input values:
 - Number of Periods – The number of electrical periods in one mechanical rotation. This value depends on the inductive coil design, it is equal to 4 for the IPS2200MROT4x90001.
 - Points per Period – The number of points sampled per one electrical period. Selecting a lower value results in a faster calibration but less accurate measurement. When the calibration

starts, the Wizard re-calculates the actual number of sample points per one electrical period and updates the relevant text box.

2. Click the “Start Calibration” button.

The calibration routine runs several actions in the following order:

- a. TX Current Check – Checks if the TX Current is set. If it is not set, the user has to write an initial value of 1mA.
- b. Target rotation check – Checks if the output signals are changing. A message is displayed to make sure that the target is rotating at a constant speed before proceeding.
- c. Period length detection – Measures the time length of one electrical period using different sampling settings. If no period is detected the calibration ends with an error message. This action can take a longer time.
- d. Calibration cycle – Reads output measurement data, calculating peak-to-peak voltages and modifying the Master Gain Register until output of the signals is within optimal signal range.

The calibration step ends by displaying a message box with the calibration result. The calculated Master Gain register value is immediately written to the SRB and prepared to be written to the NVM.

3. If the new calibration data needs to be written to the NVM of IPS2200, click the “Write Calibration to NVM” button.

Alternatively, the Wizard prompts the user to write the new calibration data to NVM when the calibration sequence is complete or when the Wizard window is closing.

The “Optimal signal range”, “Sin Vpkpk”, “Cos Vpkpk”, “Master Gain”, and “Status” fields are not editable in the Calibration Wizard.

- Optimal signal range – The peak-to-peak voltage range that is used as a target value for the calibration. Depends on the VDD selection used to power the IPS2200
- Sin Vpkpk, Cos Vpkpk – Measured peak-to-peak output values in mV for the two output signals.
- Master Gain – The Master Gain register setting used by the current measurement cycle.
- Status – The current status of the calibration routine

2.5.3. Offset Compensation

The “Offset Compensation” is used for configuring the Coil Offset Registers for the two output signals. An automatic calibration is performed by measuring the offset voltages of two output signals. Calibration objective is to find register values that will result in the closest offset value near 0. The target needs to be rotating at a constant speed between 100 rpm and 1000 rpm.

IPS2200 Calibration Wizard

Offset Compensation

1. TX Current Setup

2. Gain Stage Calibration

3. Offset Compensation

4. Mismatch Compensation

Sin Offset [mV] R1 Offset Reg Value

Cos Offset [mV] R2 Offset Reg Value

Number of Periods

Points per Period

Status: Calibration complete

0.16mV

-20.51mV

Legend: Cos (blue), Sin (red)

Figure 20. "Offset Compensation" Window

Calibrate the "Offset Compensation" by performing the following steps:

1. Specify the three input values:
 - Number of Periods – The number of electrical periods in one mechanical rotation. This value depends on the inductive coil design, it is equal to 4 for the IPS2200MROT4x90001.
 - Points per Period – The number of points sampled per one electrical period. Selecting a lower value will result in a faster calibration but less accurate measurement. When the calibration starts, the Wizard re-calculates the actual number of sample points per one electrical period and updates the relevant text box.
2. Click the "Start Calibration" button.

The calibration routine runs several actions in the following order:

 - a. TX Current Check – Checks if the TX Current is set. If it is not set, the user has to write an initial value of 1mA.
 - b. Target rotation check – Checks if the output signals are changing. A message is displayed to make sure that the target is rotating at a constant speed before proceeding.
 - c. Period length detection – Measures the time length of one electrical period using different sampling settings. If no period is detected the calibration ends with an error message. This action can take a longer time.
 - d. Calibration cycle – Reads output measurement data, calculating peak-to-peak voltages and modifying the R1 and R2 Coil Offset registers until the offsets of the signals are closest to 0.

The calibration step ends by displaying a message box with the calibration result. The calculated R1 Coil Offset and R2 Coil Offset register values are immediately written to the SRB and prepared to be written to the NVM.
3. If the new calibration data needs to be written to the NVM of IPS2200, click the "Write Calibration to NVM" button.

Alternatively, the Wizard prompts the user to write the new calibration data to NVM when the calibration sequence is complete or when the Wizard window is closing.

The “Sin Offset”, “Cos Offset”, “Cos Vpkpk”, “R1 Offset Reg Value”, “R2 Offset Reg Value”, and “Status” fields are not editable in the Calibration Wizard.

- Sin Offset, Cos Offset – Measured offset values in mV for the two output signals. The values are also displayed visually in a graph at the bottom.
- R1 Offset Reg Value, R2 Offset Reg Value – The R1 and R2 Coil Offset register settings used by the current measurement cycle.
- Status – The current status of the calibration routine

2.5.4. Mismatch Compensation

The “Mismatch Compensation” is used for configuring the Fine Gain registers for the two output signals. An automatic calibration is performed by measuring peak-to-peak voltages of the output signals. The objective of this step is to find register values that results in a mismatch ratio of 1 between Sin peak-to-peak and Cos peak-to-peak. In other words this step compensates for the amplitude mismatch between two output signals. The target needs to be rotating at a constant speed between 100 rpm and 1000 rpm.

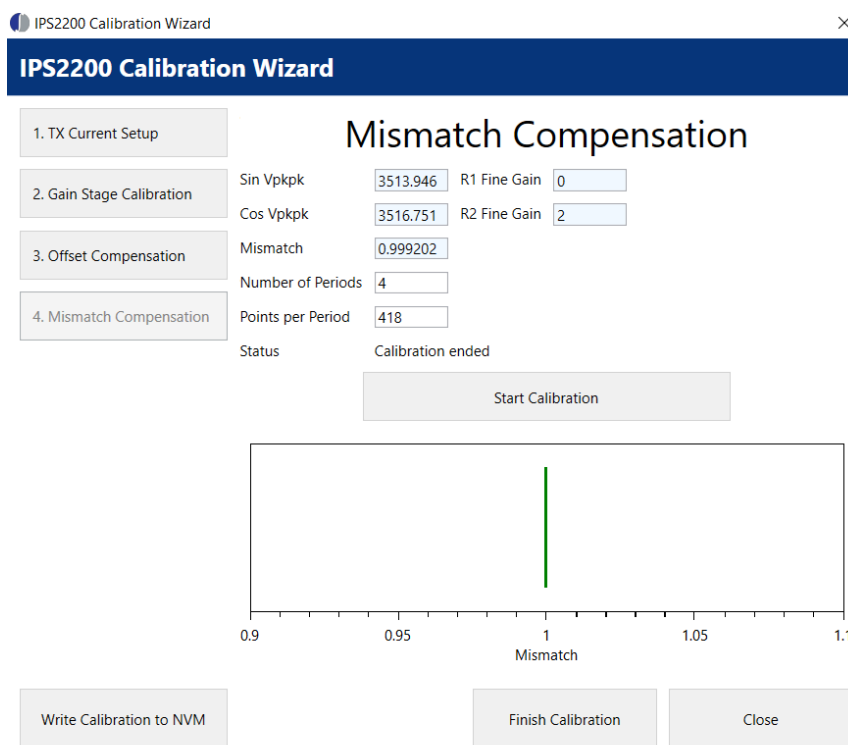

Figure 21. "Mismatch Compensation" Window

Calibrate the “Mismatch Compensation” by performing the following steps:

1. Specify the two input values:
 - Number of Periods – The number of electrical periods in one mechanical rotation. This value depends on the inductive coil design, it is equal to 4 for the IPS2200MROT4x90001.
 - Points per Period – The number of points sampled per one electrical period. Selecting a lower value results in a faster calibration but less accurate measurement. When the calibration starts, the Wizard re-calculates the actual number of sample points per one electrical period and updates the relevant text box.
2. Click the “Start Calibration” button.

The calibration routine runs several actions in the following order:

- a. TX Current Check – Checks if the TX Current is set. If it is not set, the user has to write an initial value of 1mA.
- b. Target rotation check – Checks if the output signals are changing. A message is displayed to make sure that the target is rotating at a constant speed before proceeding.
- c. Period length detection – Measures the time length of one electrical period using different sampling settings. If no period is detected the calibration ends with an error message. This action can take a longer time.
- d. Calibration cycle – Reads output measurement data, calculating peak-to-peak voltages and modifying the R1 and R2 Fine Gain registers until the mismatch ratio between two signals is closest to 1.

The calibration step ends by displaying a message box with the calibration result. The calculated R1 Fine Gain and R2 Fine Gain register values are immediately written to the SRB and prepared to be written to the NVM.

3. If the new calibration data needs to be written to the NVM of IPS2200, click the “Write Calibration to NVM” button.

Alternatively, the Wizard prompts the user to write the new calibration data to NVM when the calibration sequence is complete or when the Wizard window is closing.

The “Sin Vpkpk”, “Cos Vpkpk”, “R1 Fine Gain”, “R2 Fine Gain”, “Mismatch”, “Status” fields and the Graph are not editable in the Calibration Wizard.

- Sin Vpkpk, Cos Vpkpk – Measured peak-to-peak output values in mV for output signals.
- R1 Fine Gain, R2 Fine Gain – The R1 and R2 Fine Gain register settings used by the current measurement cycle.
- Mismatch -
- Status – The current status of the calibration routine.
- Graph - Visually displays the calculated mismatch between the two peak-to-peak values.

2.6 Working with the Memory

2.6.1. MEMORY EDIT Tab

Information for all memory types of the device and their values can be found on the “MEMORY EDIT” tab, see Figure 33. The data is organized in tables, and the register values are in hexadecimal format. The user can directly modify the memory contents of the device. Register contents that are inaccessible are masked with bit value 0.

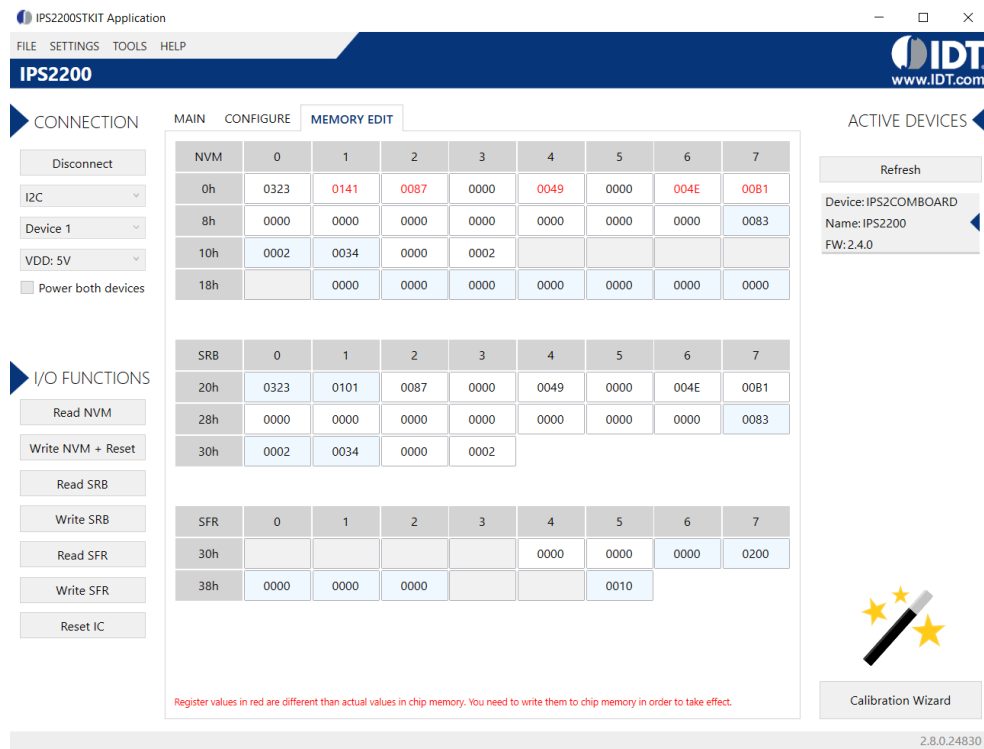

Figure 22. “MEMORY EDIT” Tab Contents – IPS2200 Example

The read-only registers are marked with a light blue background. Modified register values appear in red color until they are written to the device memory or re-read from it (see Figure 22).

Place the cursor over an element on the screen for additional information about the register.

2.6.2. Saving and Loading Memory Dump Files

The current memory configuration can be saved to a file via the “FILE” menu > “Save Memory Dump”, see Figure 36. This is useful for providing a backup of the verified memory configuration or to copy a configuration to another device.

The “Load Memory Dump” option loads a selected memory dump file into the “MEMORY EDIT” tab. The “Write NVM” button in the “I/O FUNCTIONS” section must be used to write the configuration into the memory of IPS2200.

The GUI provides a set of default memory dump files that can be used to easily return a device to its original settings.

The default memory dump files can be found in the “MemoryDumps” folder located in the main installation directory of the GUI.

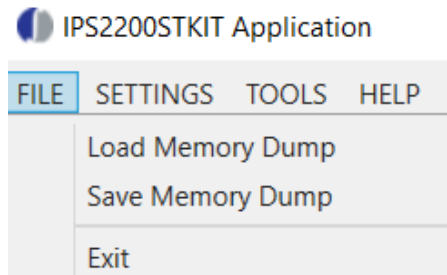

Figure 23. Menu Options for Saving and Loading Memory Dump Files

3. Firmware Update

This section provides instructions for updating the firmware of the IPS2-COMBOARD. There are two options for firmware update – automatic and manual. To determine the existing version of the firmware on the board, see the “FW” version shown in the “ACTIVE DEVICES” section at the right of the display (see Figure 7).



Important Equipment Warning: Ensure the correct connection of all cables. Supplying the board using the wrong polarity could result in damage to the board and/or the equipment.

3.1.1. Automatic Firmware Update

Every version of the GUI has the latest firmware version it is designed to work within its install directory. If a connected IPS2-COMBOARD has a lower firmware version than the GUI, it asks the user to automatically update the firmware. After selecting the “Yes” option, the GUI automatically flashes the latest firmware to the IPS2-COMBOARD.

It is always recommended to update to the latest firmware version.

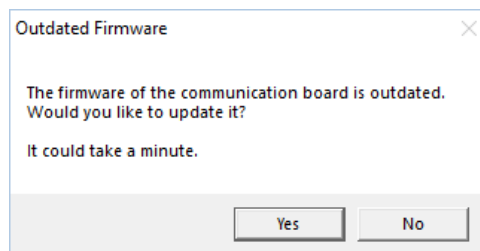

Figure 24. Automatic Firmware Update Message Box

3.1.2. Manual Firmware Update

The GUI provides also an option for a manual firmware update. It can be used to downgrade the current firmware version of the IPS2-COMBOARD or flash an alternative firmware version for specific test purposes.

Manual firmware update steps:

1. Make sure that the IPS2-COMBOARD is connected to the PC via USB and the GUI is running.
Note: Do not click the “Connect” button.
2. Select the “Update COMBOARD Firmware” option from the “TOOLS” menu.
3. Click the “Select File” button.
The GUI opens its internal firmware folder in the installation directory which has the latest firmware version.
4. Select the “firmware.cyacd” file or browse to another directory to select a different firmware file.
5. Click the “Update Firmware” button to start the firmware update.
The status bar on the dialog window shows a percentage indication of the update progress. The LED D1 on the IPS2-COMBOARD flashes in green.
Upon completion, the status bar on the dialog window will say “Done”.
6. Close the window and verify that the new firmware version is correctly showing.
New version is displayed in the “ACTIVE DEVICES” section.

If there is an issue with the update progress, an error message is displayed with details on the issue, and the firmware is not updated.

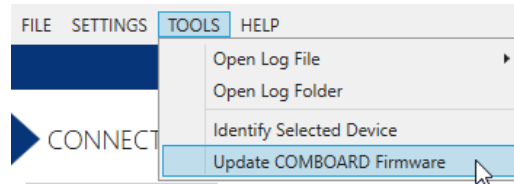

Figure 25. Manual Firmware Update Menu Option

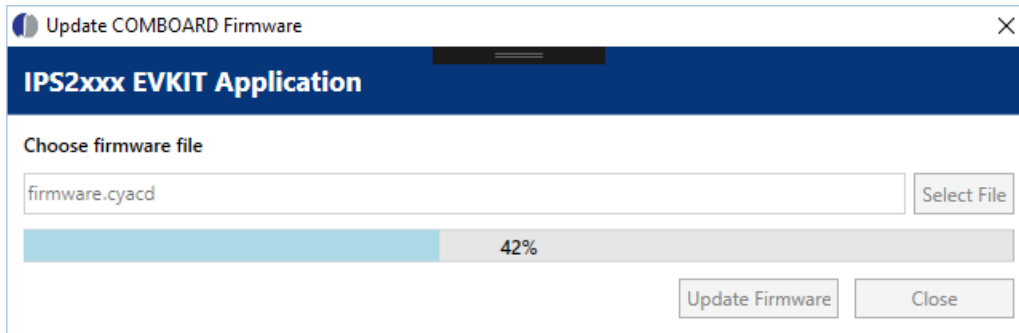
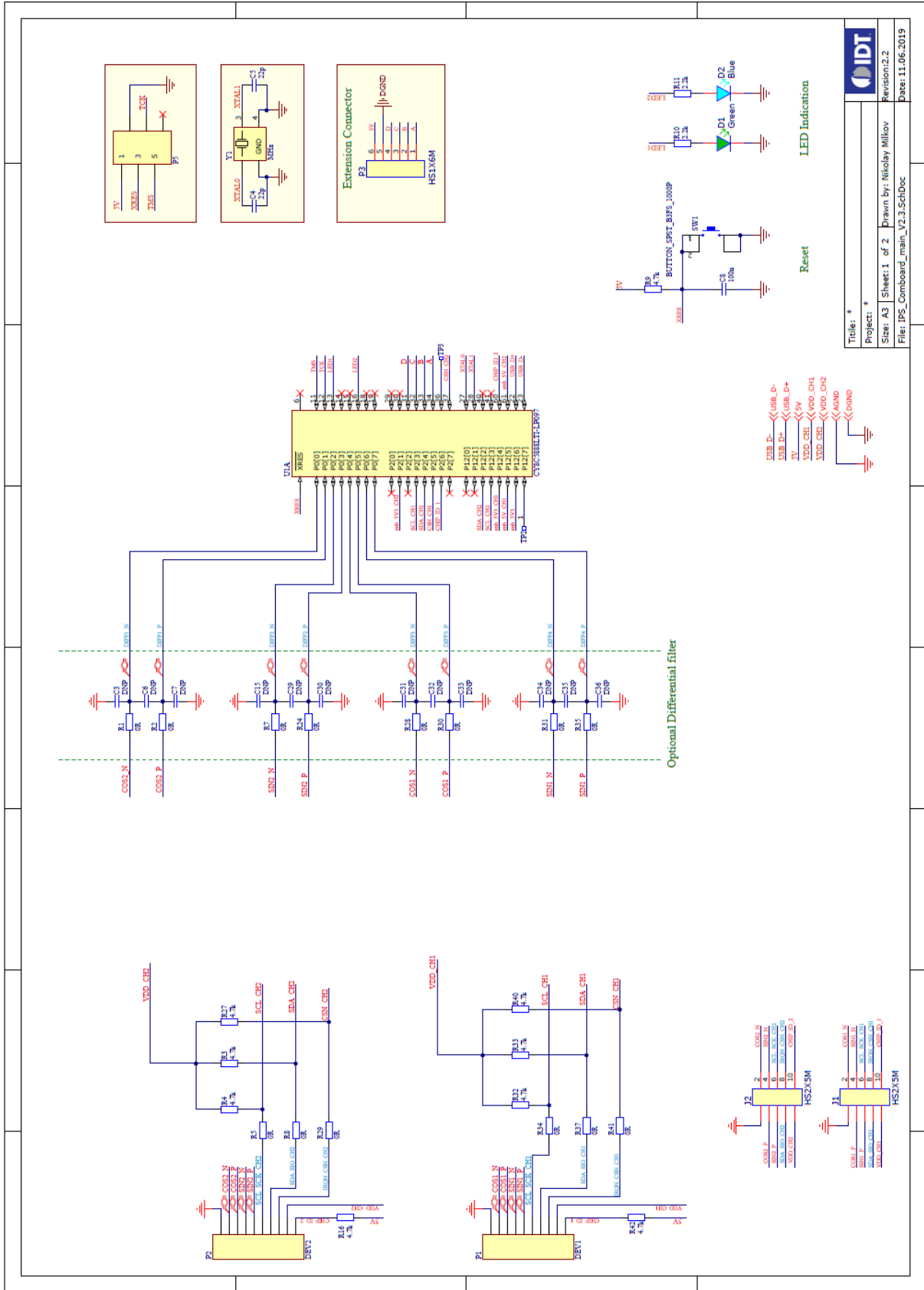
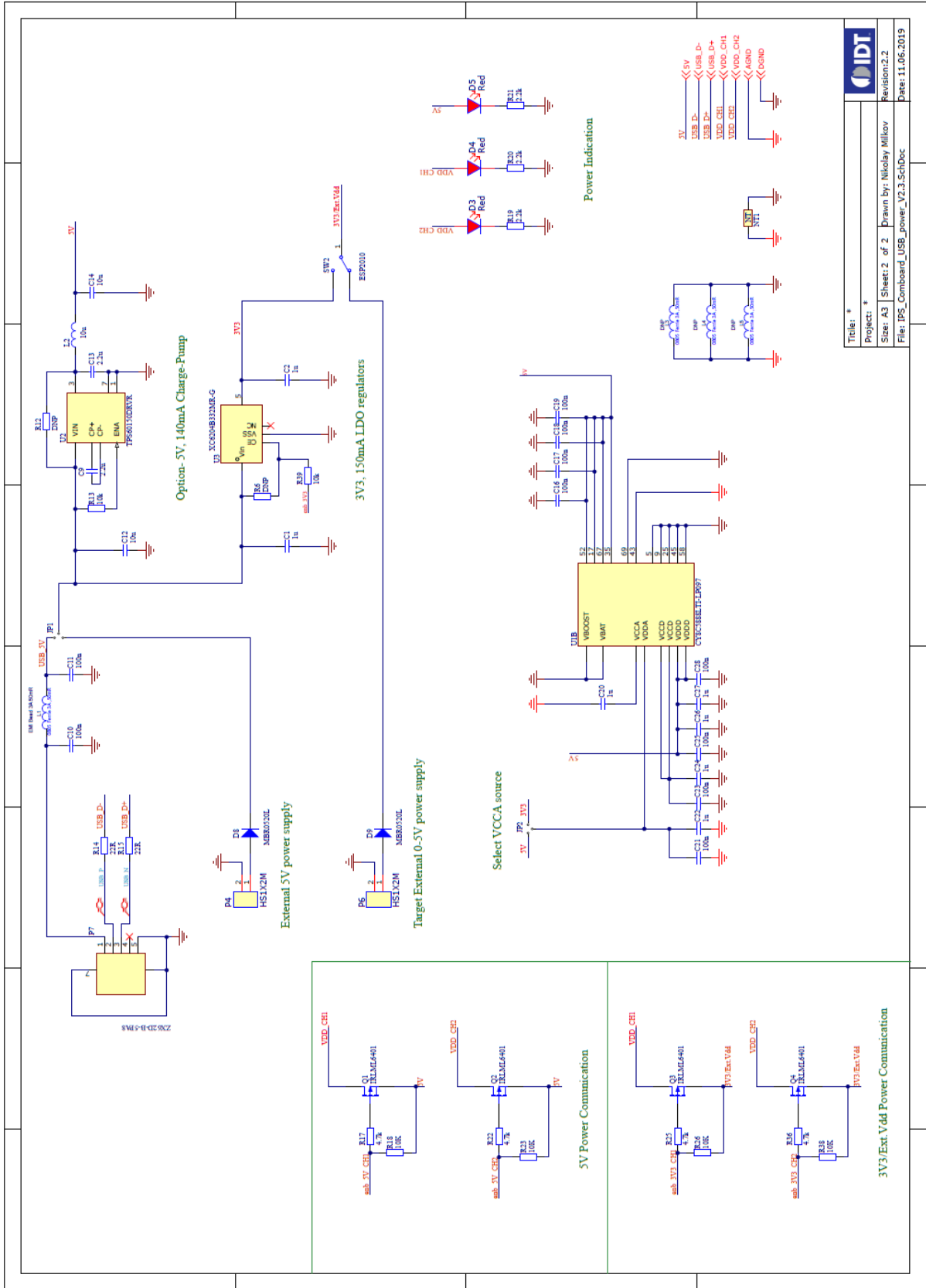

Figure 26. Manual Firmware Update Dialog Window

4. IPS2-COMBOARD Schematics



Project: *	Revision: 2.2
Size: A3 Sheet: 1 of 2	Drawn by: Nikolay Milkov
File: IPS2_Combard_main_V2.2.SchDoc	Date: 11.06.2019



Title: *	Revision: 2.2
Project: *	Revision: 2.2
Size: A3	Sheet: 2 of 2
File: IPS_Comboid_USB_power_V2.3.SchDoc	Drawn by: Nikolay Milov
	Date: 11.06.2019

5. IPS2-COMBOARD BOM

Table 3. Bill of Materials for IPS2-COMBOARD Rev. 2.3

Item	Name	Description	Footprint	Qty
1	C1, C2, C20, C22, C24, C26, C27	1.0uF 10V X5R +-10%	0603	7
2	C3, C6, C7, C15, C29, C30, C31, C32, C33, C34, C35, C36	DNP	0603	12
3	C4, C5	DNP	0603	2
4	C8, C10, C11, C16, C17, C18, C19, C21, C23, C25, C28	100nF 16V X7R +-10%	0603	11
5	C9, C13	2.2uF 16V X7R +-10%	0805	2
6	C12,C14	10uF 16V X5R +-10%	0805	2
7	D1	2.0x1.25mm, 3.2-15mcd@20mA, 568nm Green, W.Clear, 120°	0805	1
8	D2	2.0x1.25mm 80mcd/20mA 465nm Blue 120°	0805	1
9	D3, D4, D5	2.0x1.25mm 150mcd/20mA 625nm Red 120°	0805	3
10	D8, D9	Schottky 20V 500mA	SOD123	2
11	J1, J2	Board to Board/Wire Header, contact height 6.0mm, 2x5, straight PCB TH, P2.54mm		2
12	L1	Ferrite bead 0805, typ. 30Ohm@100MHz, 15mOhm@3.0A	0805	1
13	L2	Wire-wound Chip Inductor 10uH, 0.65 Ohm max, 120 mA	0805	1
14	P1,P2	Box Header Connector 2x5	BH10S	2
15	P3	Board to Board/Wire Header, contact height 6.0mm, 1x6, straight PCB TH, P2.54mm		1
16	P4	Board to Board/Wire Header, contact height 6.0mm, 1x2, straight PCB TH, P2.54mm		1
17	P5	DNP		1
18	P6	Board to Board/Wire Header, contact height 6.0mm, 1x2, straight PCB TH, P2.54mm		1
19	P7	MICRO USB, 2.0 TYPE B, RCPT, SMT/THT	USB_micro_B_SMD_2	1
20	Q1, Q2, Q3, Q4	PMOS 12V 4.3A 1.3W 0.050Ohm/4.5V	SOT23	4
21	R1, R2, R5, R7, R8, R24, R28, R29, R30, R31, R34, R35, R37, R41, R12	RES SMD 0603 JUMPER MAX 2A 50mOhm	0603	15
22	R3, R4, R9, R16, R27, R32, R33, R40, R42, R17, R22, R25, R36	RES SMD 0603 1% 100ppm 4.7K 1/10W	0603	13
23	R6,R13	DNP	0603	2
24	R10, R11, R19, R20, R21	RES SMD 0603 1% 100ppm 2.2K 1/10W	0603	5
25	R18, R23, R26, R38, R39	RES SMD 0603 1% 100ppm 10K 1/10W	0603	5
26	R14, R15	RES SMD 0603 1% 100ppm 22R 1/10W	0603	2

Item	Name	Description	Footprint	Qty
27	SW1	Tact sw. 2p SPST-NO Off-Mom. 50mA/24V 6x6x3.1mm 100gf		1
28	SW2	Switch: slide; Positions:2; SPDT; 0.5A/12VDC; ON-ON	10x2.5x6.5mm	1
29	U1	ARM Microcontroller, PSOC 5LP, ARM Cortex-M3, 32bit	QFN-68pins	1
30	U2	DC/DC Converter, Fixed, Boost , 2.7 V to 5.5 V in,140 mA	WSON - 6	0
31	U3	3.3V±2% 150mA, LDO 0.2V, Vinmax=10V	SOT23-5	1
32	Y1	DNP	4pins-SMD-3.2X2.5	1

1. DNP = Do not populate.

6. Sensors Board – IPS2200MROT4x90001

Refer to the following IDT product web page for the IPS2200MROT4x90001 manual.

7. Glossary

Term	Definition
ADC	Analog-to-Digital Converter
AGC	Automatic Gain Control
CSV	Comma Separated Values – a file format that can be imported in spreadsheets.
NVM	Non Volatile Memory – the storage memory of the IPS2XXX IC
EVK	Evaluation Kit
GUI	Graphical User Interface – refers to the application used for communication with the kit
SRB	Shadow Register Bank – the working memory of the IPS2XXX IC
SFR	Special Function Registers
LED	Light Emitting Diode
I2C / I ² C	Inter-Integrated Circuit
SPI	Serial Peripheral Interface
USB	Universal Serial Bus
RPM	Revolutions per Minute

8. Ordering Information

Refer to the product pages for the specific IPS2200 Application Module for the order codes for the module.

Orderable Part Number	Description
IPS2-COMBOARD	IPS2-COMBOARD

9. Revision History

Revision	Date	Description
1.0	Mar.10.20	Initial release.

Notice

1. Descriptions of circuits, software and other related information in this document are provided only to illustrate the operation of semiconductor products and application examples. You are fully responsible for the incorporation or any other use of the circuits, software, and information in the design of your product or system. Renesas Electronics disclaims any and all liability for any losses and damages incurred by you or third parties arising from the use of these circuits, software, or information.
2. Renesas Electronics hereby expressly disclaims any warranties against and liability for infringement or any other claims involving patents, copyrights, or other intellectual property rights of third parties, by or arising from the use of Renesas Electronics products or technical information described in this document, including but not limited to, the product data, drawings, charts, programs, algorithms, and application examples.
3. No license, express, implied or otherwise, is granted hereby under any patents, copyrights or other intellectual property rights of Renesas Electronics or others.
4. You shall be responsible for determining what licenses are required from any third parties, and obtaining such licenses for the lawful import, export, manufacture, sales, utilization, distribution or other disposal of any products incorporating Renesas Electronics products, if required.
5. You shall not alter, modify, copy, or reverse engineer any Renesas Electronics product, whether in whole or in part. Renesas Electronics disclaims any and all liability for any losses or damages incurred by you or third parties arising from such alteration, modification, copying or reverse engineering.
6. Renesas Electronics products are classified according to the following two quality grades: "Standard" and "High Quality". The intended applications for each Renesas Electronics product depends on the product's quality grade, as indicated below.

"Standard": Computers; office equipment; communications equipment; test and measurement equipment; audio and visual equipment; home electronic appliances; machine tools; personal electronic equipment; industrial robots; etc.

"High Quality": Transportation equipment (automobiles, trains, ships, etc.); traffic control (traffic lights); large-scale communication equipment; key financial terminal systems; safety control equipment; etc.

Unless expressly designated as a high reliability product or a product for harsh environments in a Renesas Electronics data sheet or other Renesas Electronics document, Renesas Electronics products are not intended or authorized for use in products or systems that may pose a direct threat to human life or bodily injury (artificial life support devices or systems; surgical implantations; etc.), or may cause serious property damage (space system; undersea repeaters; nuclear power control systems; aircraft control systems; key plant systems; military equipment; etc.). Renesas Electronics disclaims any and all liability for any damages or losses incurred by you or any third parties arising from the use of any Renesas Electronics product that is inconsistent with any Renesas Electronics data sheet, user's manual or other Renesas Electronics document.

7. No semiconductor product is absolutely secure. Notwithstanding any security measures or features that may be implemented in Renesas Electronics hardware or software products, Renesas Electronics shall have absolutely no liability arising out of any vulnerability or security breach, including but not limited to any unauthorized access to or use of a Renesas Electronics product or a system that uses a Renesas Electronics product. RENESAS ELECTRONICS DOES NOT WARRANT OR GUARANTEE THAT RENESAS ELECTRONICS PRODUCTS, OR ANY SYSTEMS CREATED USING RENESAS ELECTRONICS PRODUCTS WILL BE INVULNERABLE OR FREE FROM CORRUPTION, ATTACK, VIRUSES, INTERFERENCE, HACKING, DATA LOSS OR THEFT, OR OTHER SECURITY INTRUSION ("Vulnerability Issues"). RENESAS ELECTRONICS DISCLAIMS ANY AND ALL RESPONSIBILITY OR LIABILITY ARISING FROM OR RELATED TO ANY VULNERABILITY ISSUES. FURTHERMORE, TO THE EXTENT PERMITTED BY APPLICABLE LAW, RENESAS ELECTRONICS DISCLAIMS ANY AND ALL WARRANTIES, EXPRESS OR IMPLIED, WITH RESPECT TO THIS DOCUMENT AND ANY RELATED OR ACCOMPANYING SOFTWARE OR HARDWARE, INCLUDING BUT NOT LIMITED TO THE IMPLIED WARRANTIES OF MERCHANTABILITY, OR FITNESS FOR A PARTICULAR PURPOSE.
8. When using Renesas Electronics products, refer to the latest product information (data sheets, user's manuals, application notes, "General Notes for Handling and Using Semiconductor Devices" in the reliability handbook, etc.), and ensure that usage conditions are within the ranges specified by Renesas Electronics with respect to maximum ratings, operating power supply voltage range, heat dissipation characteristics, installation, etc. Renesas Electronics disclaims any and all liability for any malfunctions, failure or accident arising out of the use of Renesas Electronics products outside of such specified ranges.

9. Although Renesas Electronics endeavors to improve the quality and reliability of Renesas Electronics products, semiconductor products have specific characteristics, such as the occurrence of failure at a certain rate and malfunctions under certain use conditions. Unless designated as a high reliability product or a product for harsh environments in a Renesas Electronics data sheet or other Renesas Electronics document, Renesas Electronics products are not subject to radiation resistance design. You are responsible for implementing safety measures to guard against the possibility of bodily injury, injury or damage caused by fire, and/or danger to the public in the event of a failure or malfunction of Renesas Electronics products, such as safety design for hardware and software, including but not limited to redundancy, fire control and malfunction prevention, appropriate treatment for aging degradation or any other appropriate measures. Because the evaluation of microcomputer software alone is very difficult and impractical, you are responsible for evaluating the safety of the final products or systems manufactured by you.
10. Please contact a Renesas Electronics sales office for details as to environmental matters such as the environmental compatibility of each Renesas Electronics product. You are responsible for carefully and sufficiently investigating applicable laws and regulations that regulate the inclusion or use of controlled substances, including without limitation, the EU RoHS Directive, and using Renesas Electronics products in compliance with all these applicable laws and regulations. Renesas Electronics disclaims any and all liability for damages or losses occurring as a result of your noncompliance with applicable laws and regulations.
11. Renesas Electronics products and technologies shall not be used for or incorporated into any products or systems whose manufacture, use, or sale is prohibited under any applicable domestic or foreign laws or regulations. You shall comply with any applicable export control laws and regulations promulgated and administered by the governments of any countries asserting jurisdiction over the parties or transactions.
12. It is the responsibility of the buyer or distributor of Renesas Electronics products, or any other party who distributes, disposes of, or otherwise sells or transfers the product to a third party, to notify such third party in advance of the contents and conditions set forth in this document.
13. This document shall not be reprinted, reproduced or duplicated in any form, in whole or in part, without prior written consent of Renesas Electronics.
14. Please contact a Renesas Electronics sales office if you have any questions regarding the information contained in this document or Renesas Electronics products.
(Note 1) "Renesas Electronics" as used in this document means Renesas Electronics Corporation and also includes its directly or indirectly controlled subsidiaries.
(Note 2) "Renesas Electronics product(s)" means any product developed or manufactured by or for Renesas Electronics.

(Rev. 4.0-2 April 2020)

Corporate Headquarters

TOYOSU FORESIA, 3-2-24 Toyosu,
Koto-ku, Tokyo 135-0061, Japan
www.renesas.com

Contact Information

For further information on a product, technology, the most up-to-date version of a document, or your nearest sales office, please visit:
www.renesas.com/contact/

Trademarks

Renesas and the Renesas logo are trademarks of Renesas Electronics Corporation. All trademarks and registered trademarks are the property of their respective owners.