

LQM18PN2R2MFR#

“#” indicates a package specification code.

Low DC Resistance Type



< List of part numbers with package codes >

LQM18PN2R2MFRL LQM18PN2R2MFRB

Appearance & Shape

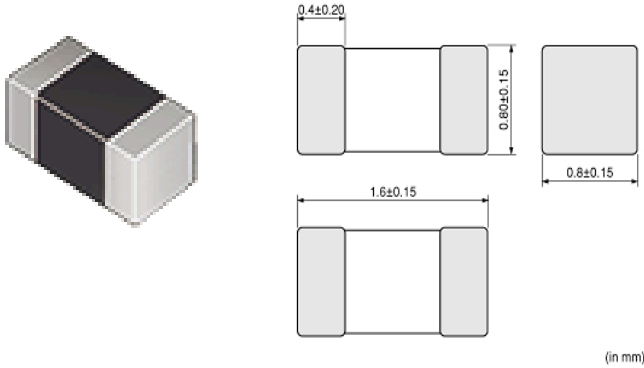

References

Packaging	Specifications	Standard Packing Quantity
L	180Embossed Tape	4000
B	Bulk(Bag)	1000

Mass (typ.)	
1 piece	0.005g

Attention

- 1.This datasheet is downloaded from the website of Murata Manufacturing Co., Ltd. Therefore, it's specifications are subject to change or our products in it may be discontinued without advance notice. Please check with our sales representatives or product engineers before ordering.
- 2.This datasheet has only typical specifications because there is no space for detailed specifications. Therefore, please review our product specifications or consult the approval sheet for product specifications before ordering.

LQM18PN2R2MFR#

“#” indicates a package specification code.

Specifications

L size	1.6±0.15mm
W size	0.8±0.15mm
T size	0.8±0.15mm
Size code inch (mm)	0603 (1608)
Inductance	2.2μH±20%
Inductance Test Frequency	1MHz
Rated current (Itemp) (Based on Temperature rise)	750mA
Max. of DC resistance	0.375Ω
Class of magnetic shield	Ferrite Core
Self resonance frequency (min.)	70MHz
DC Resistance Intermediate Values	0.30Ω±25%
Operating Temperature Range	-40°C to 85°C
Series	LQM18PN_FR

Attention

1.This datasheet is downloaded from the website of Murata Manufacturing Co., Ltd. Therefore, it's specifications are subject to change or our products in it may be discontinued without advance notice. Please check with our sales representatives or product engineers before ordering.

2.This datasheet has only typical specifications because there is no space for detailed specifications.

Therefore, please review our product specifications or consult the approval sheet for product specifications before ordering.

LQM18PN2R2MFR#

“#” indicates a package specification code.

Characteristic Data

The charts below may show another part number which shares its characteristics.

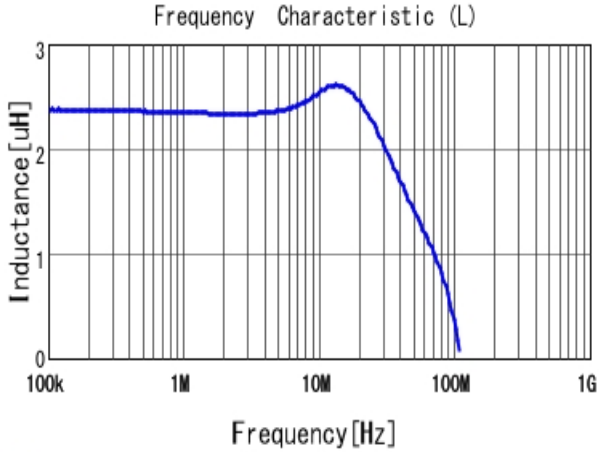

■ LQM18PN2R2MFR L

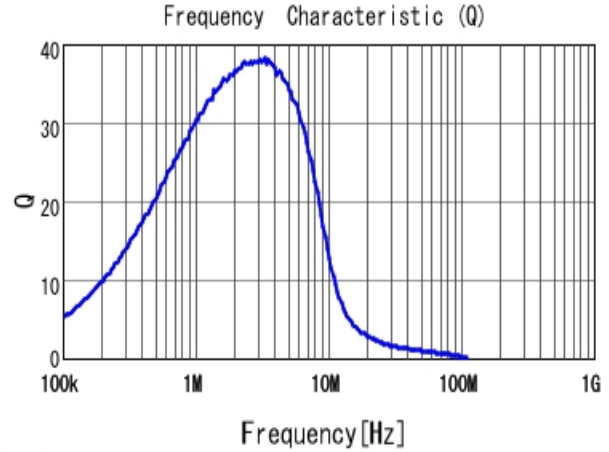

■ LQM18PN2R2MFR Q

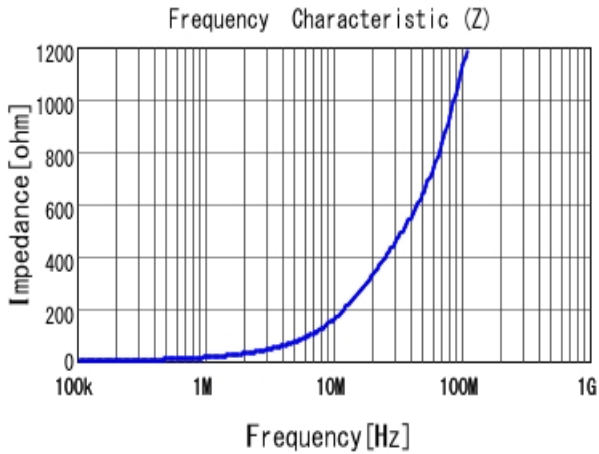

■ LQM18PN2R2MFR |Z|

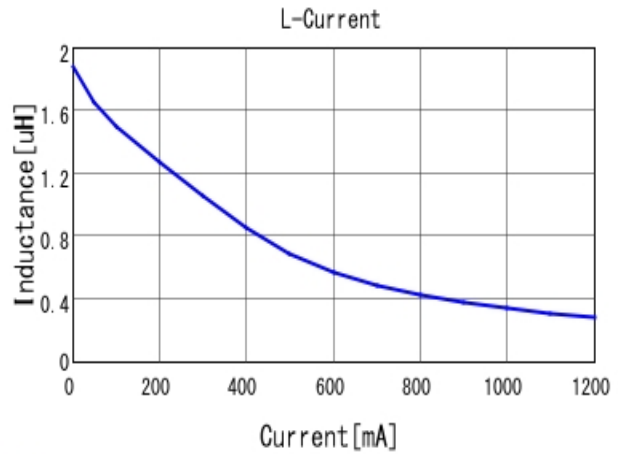

■ LQM18PN2R2MFR L-Current 20degC

Attention

- 1.This datasheet is downloaded from the website of Murata Manufacturing Co., Ltd. Therefore, it's specifications are subject to change or our products in it may be discontinued without advance notice. Please check with our sales representatives or product engineers before ordering.
- 2.This datasheet has only typical specifications because there is no space for detailed specifications. Therefore, please review our product specifications or consult the approval sheet for product specifications before ordering.

LQM18PN2R2MFR#

“#” indicates a package specification code.

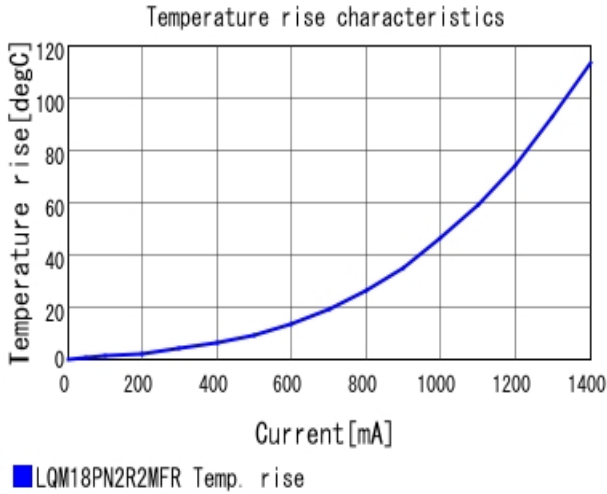

Attention

- 1.This datasheet is downloaded from the website of Murata Manufacturing Co., Ltd. Therefore, it's specifications are subject to change or our products in it may be discontinued without advance notice. Please check with our sales representatives or product engineers before ordering.
- 2.This datasheet has only typical specifications because there is no space for detailed specifications. Therefore, please review our product specifications or consult the approval sheet for product specifications before ordering.