



The Future of Analog IC Technology®

# MP7740

## 15W Class D Mono Single Ended Audio Amplifier

### DESCRIPTION

The MP7740 is a mono 15W Class D Audio Amplifier. It is one of MPS' products of fully integrated audio amplifiers which dramatically reduces solution size by integrating the following:

250mΩ power MOSFETs

Startup / Shutdown pop elimination

Short circuit protection circuits

The MP7740 utilizes a single ended output structure capable of delivering 15W into 4Ω speakers. MPS Class D Audio Amplifiers exhibit the high fidelity of a Class A/B amplifier at high efficiencies. The circuit is based on the MPS' proprietary variable frequency topology that delivers excellent linearity, fast response time and operates on a single power supply.

### FEATURES

- 15W Output at  $V_{DD} = 24V$  into a 4Ω load
- THD+N = 0.05% at 1W, 8Ω
- 90% Efficiency at 15W &  $V_{DD}=24V$
- Low Noise (103μV Typical)
- Switching Frequency Up to 1MHz
- 9.5V to 36V Operation from a Single Supply
- Integrated Startup and Shutdown Pop Elimination Circuit
- Thermal and Short Circuit Protection
- Integrated Power FETs
- Pin Compatible with MP7720
- Available in Tiny 8-Pin SOIC Package

### APPLICATIONS

- Portable Docking Stations
- Surround Sound DVD Systems
- Televisions
- Flat Panel Monitors
- Multimedia Computers
- Home Stereo Systems

"MPS" and "The Future of Analog IC Technology" are Registered Trademarks of Monolithic Power Systems, Inc.

AAM (Analog Adaptive Modulation) is a Trademark of Monolithic Power Systems, Inc.

### TYPICAL APPLICATION

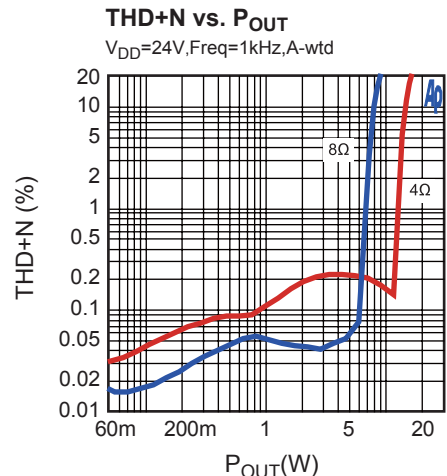
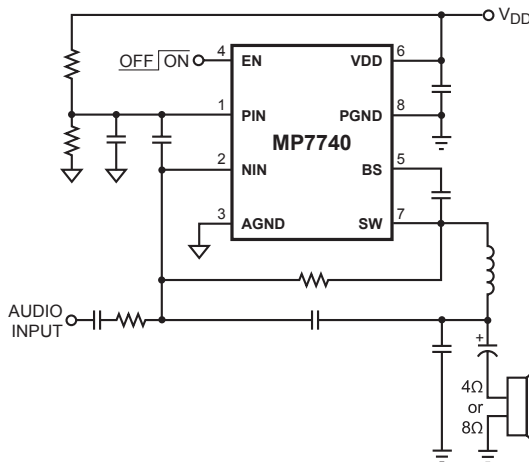

## ORDERING INFORMATION

Part Number*	Package	Top Marking	Temperature
MP7740DN	SOIC8E	MP7740DN	-40°C to +85°C

\*For Tape & Reel, add suffix -Z (eg. MP7740DN-Z); For RoHS compliant packaging, add suffix -LF (eg. MP7740DN-LF-Z)

## PACKAGE REFERENCE

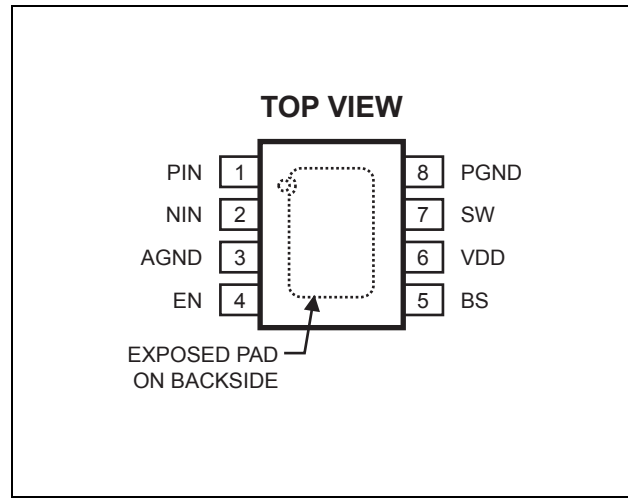

### ABSOLUTE MAXIMUM RATINGS <sup>(1)</sup>

Supply Voltage $V_{DD}$ .....	40V
BS Voltage.....	$V_{SW} - 0.3V$ to $V_{SW} + 6.5V$
Enable Voltage $V_{EN}$ .....	-0.3V to +6V
$V_{SW}$ .....	-1V (-5V for <10ns) to $V_{DD} + 1V$
$V_{PIN}, V_{NIN}$ .....	-1V to $V_{DD} + 1V$
AGND to PGND.....	-0.3V to +0.3V
Continuous Power Dissipation ( $T_A = +25^\circ C$ ) (2).....	2.5W
Junction Temperature.....	150°C
Lead Temperature.....	260°C
Storage Temperature.....	-65°C to +150°C

### Recommended Operating Conditions <sup>(3)</sup>

Supply Voltage $V_{DD}$ .....	9.5V to 36V
Operating Temperature $T_A$ .....	-40°C to +85°C

<i>Thermal Resistance</i> <sup>(4)</sup>	$\theta_{JA}$	$\theta_{JC}$
SOIC8E .....	50	8.....°C

**Notes:**

- 1) Exceeding these ratings may damage the device.
- 2) The maximum allowable power dissipation is a function of the maximum junction temperature  $T_J$  (MAX), the junction-to-ambient thermal resistance  $\theta_{JA}$ , and the ambient temperature  $T_A$ . The maximum allowable continuous power dissipation at any ambient temperature is calculated by  $P_D$  (MAX) =  $(T_J$  (MAX)- $T_A$ ) /  $\theta_{JA}$ . Exceeding the maximum allowable power dissipation will cause excessive die temperature, and the regulator will go into thermal shutdown. Internal thermal shutdown circuitry protects the device from permanent damage.
- 3) The device is not guaranteed to function outside of its operating conditions.
- 4) Measured on JESD51-7, 4-layer PCB.

**ELECTRICAL CHARACTERISTICS (5, 6)**
 **$V_{DD} = 24V$ ,  $V_{EN} = 5V$ ,  $T_A = +25^{\circ}C$ , unless otherwise noted.**

Parameters	Symbol	Condition	Min	Typ	Max	Units
<b>Supply Current</b>						
Standby Current		$V_{EN} = 0V$		20	50	$\mu A$
Quiescent Current		SW=0V		1.5	3.0	mA
<b>Output Drivers</b>						
SW On Resistance		Sourcing and Sinking		0.25		$\Omega$
Short Circuit Current		Sourcing and Sinking		4.5		A
<b>Inputs</b>						
PIN, NIN Input Common Mode Voltage Range			0	$\frac{V_{DD}}{2}$	$V_{DD} - 1.5$	V
PIN, NIN Input Current		$V_{PIN} = V_{NIN} = 12V$		1	5	$\mu A$
EN Enable Threshold Voltage		$V_{EN}$ Rising		1.8	2.5	V
		$V_{EN}$ Falling	0.8	1.2		V
EN Enable Input Current		$V_{EN} = 5V$		1		$\mu A$
<b>Thermal Shutdown</b>						
Thermal Shutdown Trip Point		$T_J$ Rising		150		$^{\circ}C$
Thermal Shutdown Hysteresis				30		$^{\circ}C$

**Notes:**

- 5) The device is not guaranteed to function outside its operating rating.  
 6) Electrical Characteristics are for the IC only with no external components except bypass capacitors.

**OPERATING SPECIFICATIONS (7)**
**Circuit of Figure 1,  $V_{DD} = 24V$ ,  $V_{EN} = 5V$ ,  $T_A = +25^{\circ}C$ , unless otherwise noted.**

Parameters	Symbol	Condition	Min	Typ	Max	Units
Standby Current		$V_{EN} = 0V$		130		$\mu A$
Quiescent Current				13		mA
Power Output		f = 1KHz, THD+N = 10%, 4 $\Omega$ Load		15		W
		f = 1KHz, THD+N = 10%, 8 $\Omega$ Load		8		W
THD+ Noise		$P_{OUT} = 1W$ , f = 1kHz, 4 $\Omega$ Load		0.05		%
		$P_{OUT} = 1W$ , f = 1kHz, 8 $\Omega$ Load		0.018		%
Efficiency		f = 1KHz, $P_{OUT} = 15W$ , 4 $\Omega$ Load		90		%
		f = 1KHz, $P_{OUT} = 8W$ , 8 $\Omega$ Load		90		%
Maximum Power Bandwidth				20		kHz
Dynamic Range				97		dB
Noise Floor		A-Weighted		103		$\mu V$
Power Supply Rejection		$V_{CC}=24V$ , Gain=8.25V/V, $V_{RIPPLE}=200mV_{PP}$ $C_R=100\mu F$	f = 1kHz		-60	dB
			f = 100Hz		-60	dB

**Notes:**

- 7) Operating Specifications are for the IC in Typical Application circuit (Figure 1).

## PIN FUNCTIONS

Pin #	Name	Description
1	PIN	Amplifier Positive Input. PIN is the positive side of the differential input to the amplifier. Use a resistive voltage divider to set the voltage at PIN to $V_{DD}/2$ . See Figure 1.
2	NIN	Amplifier Negative Input. NIN is the negative side of the differential input to the amplifier. Drive the input signal and close the feedback loop at NIN. See Figure 1.
3	AGND	Analog Ground. Connect AGND to PGND at a single point.
4	EN	Enable Input. Drive EN high to turn on the amplifier, low to turn it off.
5	BS	High-Side MOSFET Bootstrap Input. A capacitor from BS to SW supplies the gate drive current to the internal high-side MOSFET.
6	VDD	Power Supply Input. VDD is the drain of the high-side MOSFET switch, and supplies the power to the output stage and the MP7740 internal control circuitry. In addition to the main bulk capacitor, bypass VDD to PGND with a 1 $\mu$ F X7R capacitor placed close to pins 6 and 8.
7	SW	Switched Power Output. SW is the output of the MP7740. Connect the LC filter between SW and the output coupling capacitor. See Figure 1.
8	PGND	Power Ground. Connect PGND to AGND at a single point.
	Exposed Pad	Connect exposed pad to GND plane for proper thermal performance.

**TYPICAL PERFORMANCE CURVES**

Circuit of Figure 1,  $V_{DD}=24V$ ,  $V_{EN}=5V$ ,  $A_V=8.25V/V$ ,  $T_A = +25^\circ C$ , unless otherwise noted.

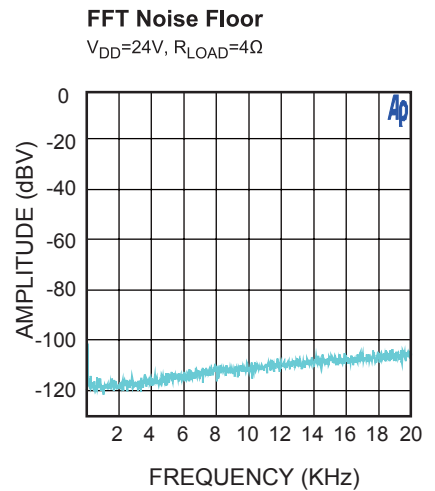
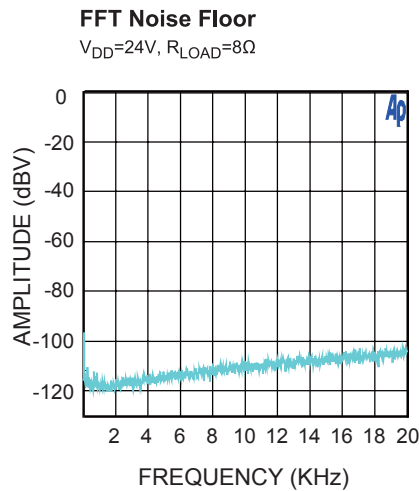
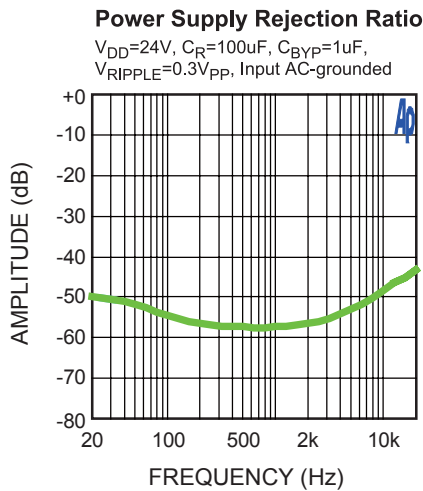
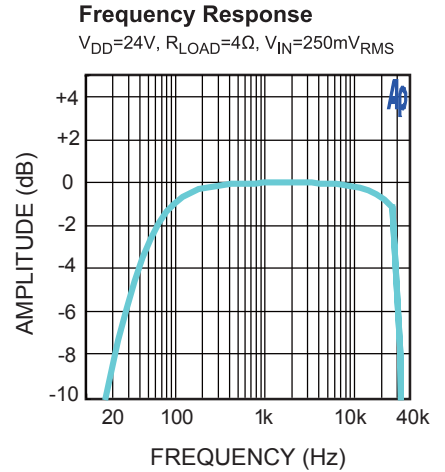
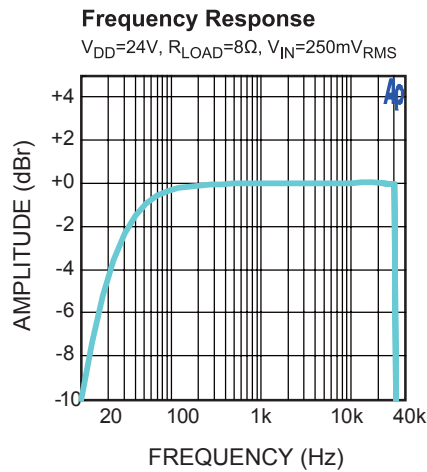
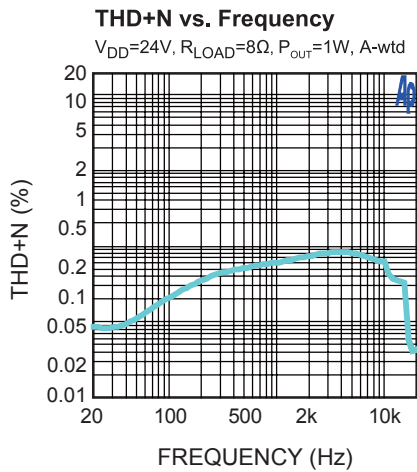
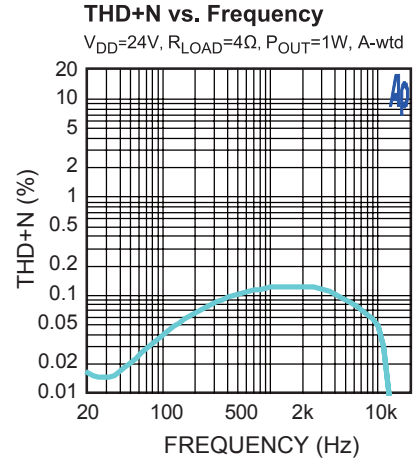
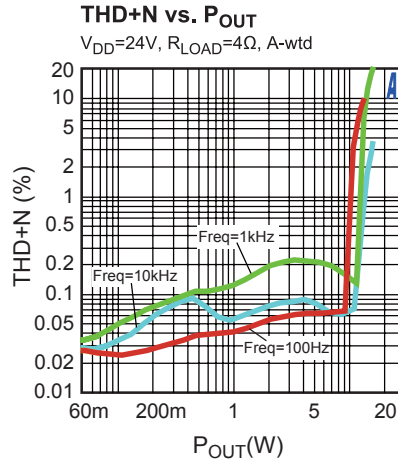
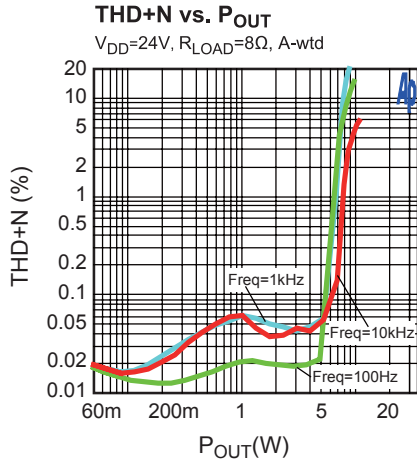

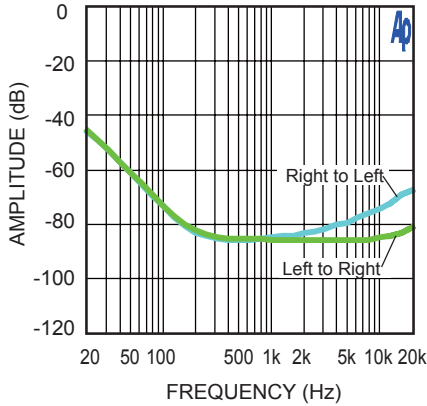
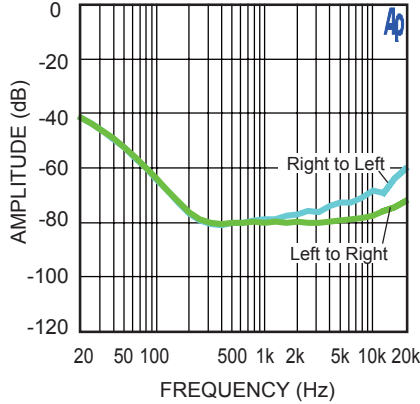
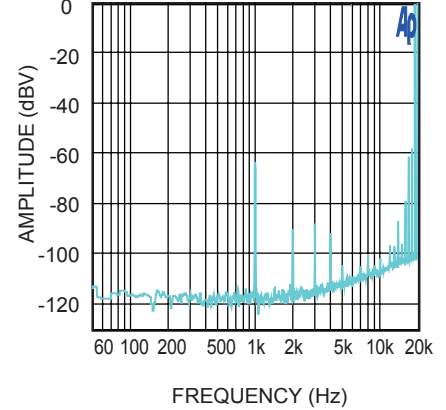
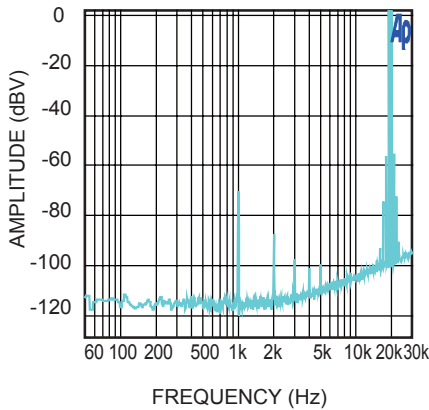
**TYPICAL PERFORMANCE CURVES (continued)**
**Circuit of Figure 1,  $V_{DD}=24V$ ,  $V_{EN}=5V$ ,  $T_A = +25^{\circ}C$ , unless otherwise noted.**
**Cross Talk**
 $V_{DD}=24V$ ,  $R_{LOAD}=8\Omega$ ,  $P_{OUT}=5W$ 

**Cross Talk**
 $V_{DD}=24V$ ,  $R_{LOAD}=4\Omega$ ,  $P_{OUT}=5W$ 

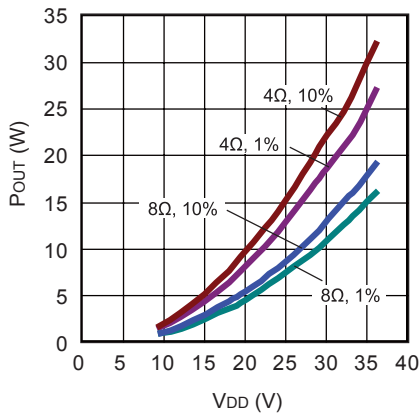
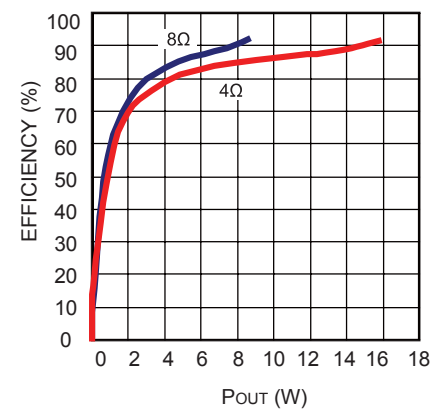
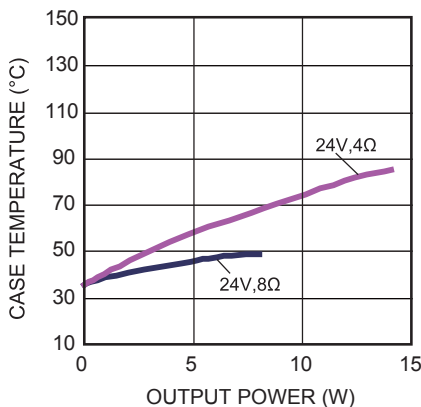
**IHF-IMD**
 $V_{DD}=24V$ ,  $R_{LOAD}=4\Omega$ ,  $P_{OUT}=1W$ ,  
Test Tones: 19kHz and 20kHz

**IHF-IMD**
 $V_{DD}=24V$ ,  $R_{LOAD}=8\Omega$ ,  $P_{OUT}=1W$ ,  
Test Tones: 19kHz and 20kHz

 **$P_{OUT}$  vs.  $V_{DD}$** 

Input Signal Freq=1kHz

**Efficiency vs.  $P_{OUT}$** 
 $V_{DD}=24V$ , Input Signal Freq=1kHz

**Thermal Rise vs. Output Power**
 $V_{DD}=24V$ 

## OPERATION

The MP7740 is a single-ended Class D audio amplifier. It uses the Monolithic Power Systems patented Analog Adaptive Modulation™ to convert the audio input signal into pulses. These pulses drive an internal high-current output stage and, when filtered through an external inductor-capacitor filter, reproduce the input signal across the load. Because of the switching Class D output stage, power dissipation in the amplifier is drastically reduced when compared to Class A, B or A/B amplifiers while maintaining high fidelity and low distortion.

The amplifier uses differential input to the modulator. PIN is the positive input and NIN is the negative input. The common mode voltage of the input is set to half the DC power supply input voltage ( $V_{DD}/2$ ) through the resistive voltage divider. The input capacitor  $C_{IN}$  couple the AC signal at the input.

The amplifier voltage gain is set by the combination of the input resistor  $R_{IN}$  and the feedback resistor  $R_{FB}$  and is calculated by the equation:

$$AV = \frac{-R_{FB}}{R_{IN}}$$

The output driver stage uses two 250mΩ N-Channel MOSFETs to deliver the pulses to the LC output filter which in turn drives the load. To fully enhance the high-side MOSFET, the gate is driven to a voltage higher than the source by the bootstrap capacitor between SW and BS. While the output is driven low, the bootstrap capacitor is charged from  $V_{DD}$  through an internal circuit on the MP7740. The gate of the high-side MOSFET is driven high from the voltage at BS, forcing the MOSFET gate to a voltage higher than  $V_{DD}$  and allowing the MOSFET to fully turn on, reducing power loss in the amplifier.

### Pop Elimination

The capacitor  $C_{OUT}$  blocks the DC signal and pass only AC signals to the load. To insure that the amplifier passes low frequency signals, the time constant of  $C_{OUT} * R_{LOAD}$  needs to be long. However, when EN is asserted, the capacitor charges over a long period and in a normal amplifier can result in a turn on and/or turn off “pop.” The MP7740 includes integrated circuitry that eliminates the turn on and turn off pop associated with the charging of the AC coupling capacitor.

### Short Circuit/Overload Protection

The MP7740 has internal overload and short circuit protection. The currents in both the high-side and low-side MOSFETs are measured and if the current exceeds the 4.5A short circuit current limit, both MOSFETs are turned off. The MP7740 then restarts with the same power up sequence that is used for normal starting to prevent a pop from occurring after a short circuit condition is removed.

A schottky diode (for example, B340LA manufactured by Diodes Inc) is required for short-circuit protection, with the cathode connected to SW and the anode connected to PGND. Please place the diode as close to the MP7740 as possible.

If short-circuit protection is not needed, the Schottky diode can be omitted.

### Mute/Enable Function

The MP7740 EN input is an active high enable control. To enable the MP7740, drive EN with a 2.5V or greater voltage. To disable the amplifier, drive it below 1V. While the MP7740 is disabled, the VDD operating current is less than 5μA and the output driver MOSFETs are turned off.

## APPLICATION INFORMATION

### COMPONENT SELECTION

The MP7740 uses a minimum number of external components to complete a stereo Class D audio amplifier. The circuit of Figure 1 should be suitable for most applications, and use the following sections to determine how to customize the amplifier for a particular application.

#### Setting the Voltage Gain

The maximum output voltage swing is limited by the power supply. To achieve the maximum power out of the MP7740 amplifier, set the gain such that the maximum input signal results in the maximum output voltage swing.

The maximum output voltage swing is  $\pm V_{DD}/2$ . For a given input signal voltage, where  $V_{IN}$  (pk) is the peak input voltage, the maximum voltage gain is:

$$A_V(\text{MAX}) = \frac{V_{DD}}{2 \times V_{IN}(\text{pk})}$$

This voltage gain setting results in the peak output voltage approaching its maximum for the maximum input signal. In some cases the amplifier is allowed to overdrive slightly, allowing the THD to increase at high power levels, and so a higher gain than  $A_V(\text{max})$  is required.

#### Setting the Switching Frequency

The idle switching frequency (the switching frequency when no audio input is present) is a function of several variables: the supply voltage  $V_{DD}$ , the timing capacitor  $C_{INT}$  and the feedback resistor  $R_{FB}$ . Lower switching frequencies result in more inductor ripple, causing more quiescent output voltage ripple and increasing the output noise and distortion. Higher switching frequencies result in more power loss. The optimum quiescent switching frequency is approximately 600KHz to 700KHz. Refer to the Operating Specifications for recommended values.

**Table 1—Switching Frequency vs.  $V_{DD}$ , Timing Capacitor and Feedback Resistor (see Figure 1)**

Gain (V/V)	Gain (dB)	$R_{FB}$ (k $\Omega$ )	$R_{IN}$ (k $\Omega$ )	$C_{INT}$	$F_{SW}$	$V_{DD}$ (V)
3.9	11.8	39	10	6.8nF	660KHz	12
8.2	18.3	82	10	3.3nF	660KHz	12
8.3	18.4	39	4.7	6.8nF	660KHz	12
12.0	21.6	120	10	2.2nF	610KHz	12
17.4	24.8	82	4.7	3.3nF	660KHz	12
25.5	28.1	120	4.7	2.2nF	610KHz	12
5.6	15.0	56	10	8.2nF	670KHz	24
8.2	18.3	82	10	5.6nF	720KHz	24
11.9	21.5	56	4.7	8.2nF	670KHz	24
12.0	21.6	120	10	4.7nF	620KHz	24
17.4	24.8	82	4.7	5.6nF	720KHz	24
25.5	28.1	120	4.7	4.7nF	620KHz	24
33.0	30.4	330	10	1.8nF	700KHz	24

#### Choosing the LC Filter

The Inductor-Capacitor (LC) filter converts the pulse train at SW to the output voltage that drives the speaker.

The characteristic frequency of the LC filter needs to be high enough to allow high frequency audio to the output, yet needs to be low enough to filter out high frequency products of the pulses from SW. The characteristic frequency of the LC filter is:

$$f_0 = \frac{1}{2\pi\sqrt{LC}}$$

The voltage ripple at the output is approximated by the equation:

$$V_{\text{RIPPLE}} \cong V_{DD} \times \left( \frac{f_0}{f_{SW}} \right)$$

The quality factor (Q) of the LC filter is important. If this is too low, output noise will increase, if this is too high, then peaking may occur at high signal frequencies reducing the passband flatness. The circuit Q is set by the load resistance (speaker resistance, typically 4 $\Omega$  or 8 $\Omega$ ). The Q is calculated as:



$$Q = \omega_0 \times \frac{L}{R_{LOAD}} = 2\pi \times f_0 \times \frac{L}{R_{LOAD}}$$

$\omega_0$  is the characteristic frequency in radians per second and  $f_0$  is in Hz. Use an LC filter with Q between 0.7 and 1.

The actual output ripple and noise is greatly affected by the type of inductor and capacitor used in the LC filter. Use a film capacitor and an inductor with sufficient power handling capability to supply the output current to the load. The inductor should exhibit soft saturation characteristics. If the inductor exhibits hard saturation, it should operate well below the saturation current. Gapped ferrite, MPP, Powdered Iron, or similar type toroidal cores are recommended. If open or shielded bobbin ferrite cores are used for multi-channel designs, make sure that the start windings of each inductor line up (all starts going toward SW pin, or all starts going toward the output) to prevent crosstalk or other channel-to-channel interference.

### Output Coupling Capacitor

The output AC coupling capacitor  $C_{OUT}$  serves to block DC voltages and thus passes only the amplified AC signal from the LC filter to the load. The combination of the coupling capacitor,  $C_{OUT}$  and the load resistance results in a first-order high-pass filter. The value of  $C_{OUT}$  should be selected such that the required minimum frequency is still allowed to pass. The output corner frequency (-3dB point),  $f_{OUT}$ , can be calculated as:

$$f_{OUT} = \frac{1}{2 \times \pi \times R_{LOAD} \times C_{OUT}}$$

Set the output corner frequency ( $f_{OUT}$ ) at or below the minimum required frequency.

The output coupling capacitor carries the full load current, so a capacitor should be chosen such that its ripple current rating is greater than the maximum load current. Low ESR aluminum electrolytic capacitors are recommended.

### Input Coupling Capacitor

The input coupling capacitor  $C_{IN}$  is used to pass only the AC signal at the input. In a typical system application, the source input signal is typically centered around the circuit ground, while the MP7740 input is at half the power supply voltage ( $V_{DD}/2$ ). The input coupling capacitor

transmits the AC signal from the source to the MP7740 while blocking the DC voltage. Choose an input coupling capacitor such that the corner frequency ( $f_{IN}$ ) is less than the passband frequency. The corner frequency is calculated as:

$$f_{IN} = \frac{1}{2 \times \pi \times R_{IN} \times C_{IN}}$$

### Power Source

For maximum output power, the amplifier circuit requires a regulated external power source to supply the power to the amplifier. The higher the power supply voltage, the more power can be delivered to a given load resistance, however if the power source voltage exceeds the maximum voltage of 36V, the MP7740 may sustain damage. The power supply rejection of the MP7740 is excellent (typically -60dB), however noise at the power supply can get to the output, so care must be taken to minimize power supply noise within the pass-band frequencies. Bypass the power supply with a large capacitor (typically aluminum electrolytic) along with a smaller 1 $\mu$ F ceramic capacitor at the MP7740  $V_{DD}$  supply pins.

### PCB Layout

The circuit layout is critical for optimum performance and low output distortion and noise. It is highly recommended to duplicate EVB layout for optimum performance. If change is necessary, please follow these guidelines and take Figure 2 for references.

1) Place the following components as close to the MP7740 as possible:

#### Bootstrap Cap

$C_{BS}$  is used to supply the gate drive current to the internal high-side MOSFET. Place  $C_{BS}$  as close to pins 5 and 7 as possible.

#### Power Supply Bypass

$C_{BYP}$  carries the transient current for the switching power stage. To prevent overstressing of the MP7740 and excessive noise at the output, place  $C_{BYP}$  as close to pins 6 ( $V_{DD}$ ) and 8 ( $PGND$ ) as possible.

### Output Catch Diodes

$D_{SH}$  and  $D_{SL}$  carry the current over the dead-time while the MOSFET switches are off. Place the diodes as close to the MP7740 as possible.

### Timing Capacitors

$C_{INT}$  is used to set the amplifier switching frequencies and are typically on the order of a few nF. Place  $C_{INT}$  as close to pins 1 and 2 as possible to reduce distortion and noise.

### Reference Bypass Capacitors

$C_R$  filters the  $\frac{1}{2} V_{DD}$  reference voltages. Place  $C_R$  as close to the IC as possible to improve power supply rejection and reduce distortion and noise at the output.

2) The Inductor-Capacitor (LC) filter converts the pulse train at SW to the output voltage that drives the speaker. Please keep the filter capacitor close to the inductor.

3) When laying out the PCB, use two separate ground planes, analog ground (AGND) and power ground (PGND), and connect the two grounds together at a single point (usually around the bulk bypass capacitor) to prevent noise injection into the amplifier input to reduce distortion.

4) Keep the sensitive feedback signal trace on the input side and shield the trace with the AGND plane. Make sure that any traces carrying the switch node (SW) voltages are separated far from any input signal traces. If it is required to run the SW trace near the input, shield the input with a ground plane between the traces. If multiple amplifiers are used on a single board, make sure that each channel is physically separated to prevent crosstalk. Make sure that all inductors used on a single circuit board have the same orientation.

If multiple amplifiers are used on a single board, make sure that the power supply is routed from the source to each channel individually, not serially. This prevents channel-to-channel coupling through the power supply input.

### **Electro-Magnetic Interference (EMI) Considerations**

Due to the switching nature of the Class D amplifier, care must be taken to minimize the effects of electromagnetic interference from the amplifier. However, with proper component selection and careful attention to circuit layout, the effects of the EMI due to the amplifier switching can be minimized.

The power inductors are a potential source of radiated emissions. For the best EMI performance, use toroidal inductors, since the magnetic field is well contained inside the core. However toroidal inductors can be expensive to wind. For a more economical solution, use shielded gapped ferrite or shielded ferrite bobbin core inductors. These inductors typically do not contain the field as well toroidal inductors, but usually can achieve a better balance of good EMI performance with low cost.

The size of high-current loops that carry rapidly changing currents needs to be minimized. To do this, make sure that the  $V_{DD}$  bypass capacitors are as close to the MP7740 as possible.

Nodes that carry rapidly changing voltage, such as SW, need to be made as small as possible. If sensitive traces run near a trace connected to SW, place a ground shield between the traces.

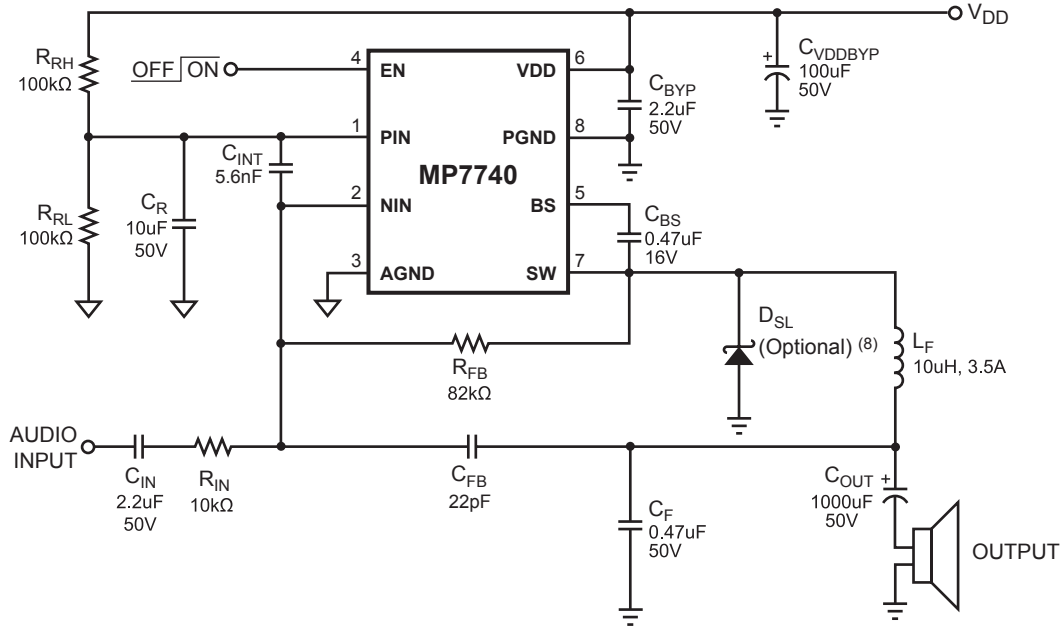
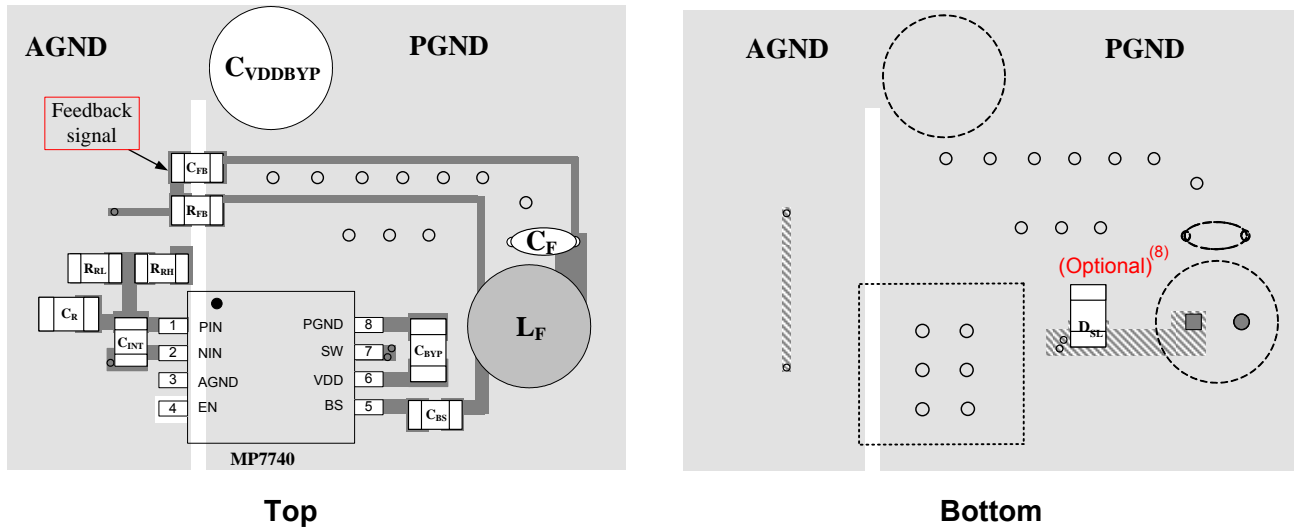
**TYPICAL APPLICATION CIRCUIT**

**Figure 1— Mono Typical Application Circuit**

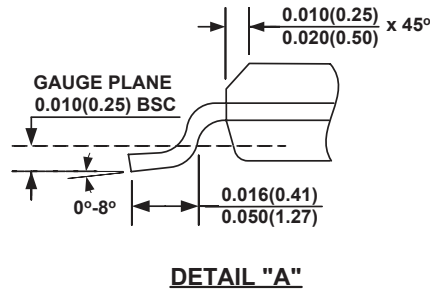
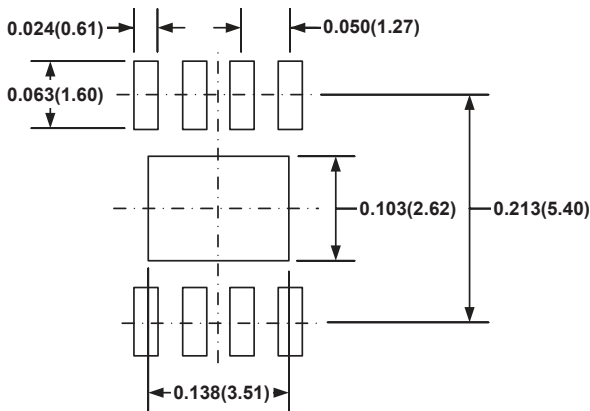
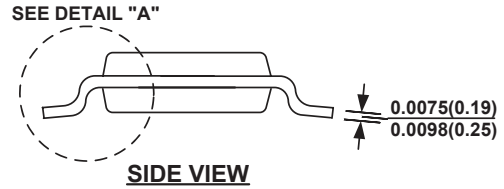
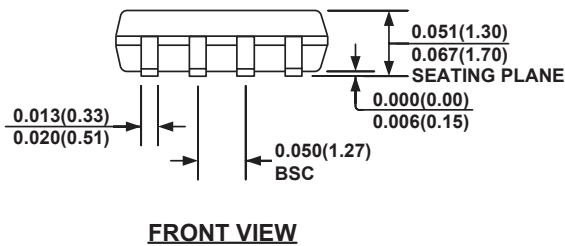
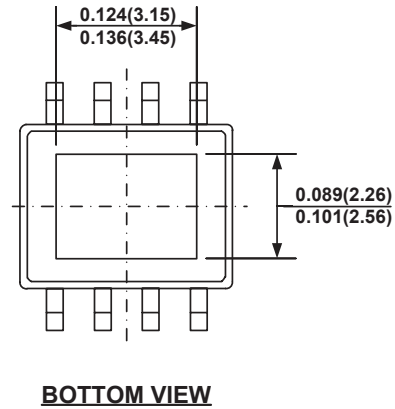
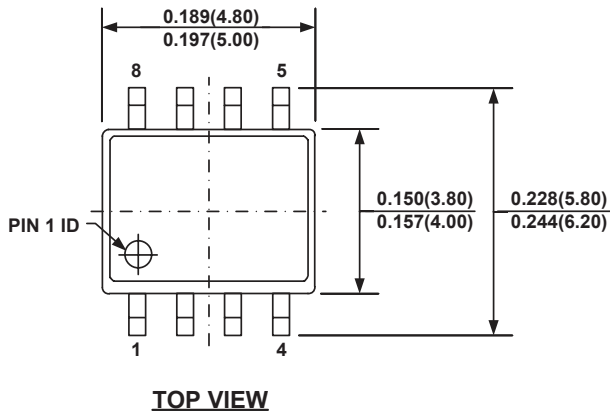
**Figure 2—Reference PCB Layout**
**Notes:**

- 8) Schottky diode  $D_{SL}$  only be required for short circuit protection. Detailed see SHORT CIRCUIT/OVERLOAD PROTECTION section in Operation Information.

**PACKAGE INFORMATION**
**SOIC8E (EXPOSED PAD)**

**NOTE:**

- 1) CONTROL DIMENSION IS IN INCHES. DIMENSION IN BRACKET IS IN MILLIMETERS.
- 2) PACKAGE LENGTH DOES NOT INCLUDE MOLD FLASH, PROTRUSIONS OR GATE BURRS.
- 3) PACKAGE WIDTH DOES NOT INCLUDE INTERLEAD FLASH OR PROTRUSIONS.
- 4) LEAD COPLANARITY (BOTTOM OF LEADS AFTER FORMING) SHALL BE 0.004" INCHES MAX.
- 5) DRAWING CONFORMS TO JEDEC MS-012, VARIATION BA.
- 6) DRAWING IS NOT TO SCALE.

**NOTICE:** The information in this document is subject to change without notice. Please contact MPS for current specifications. Users should warrant and guarantee that third party Intellectual Property rights are not infringed upon when integrating MPS products into any application. MPS will not assume any legal responsibility for any said applications.

# Mouser Electronics

Authorized Distributor

Click to View Pricing, Inventory, Delivery & Lifecycle Information:

[Monolithic Power Systems \(MPS\):](#)

[MP7740DN-LF-Z](#) [MP7740DN-LF-P](#)