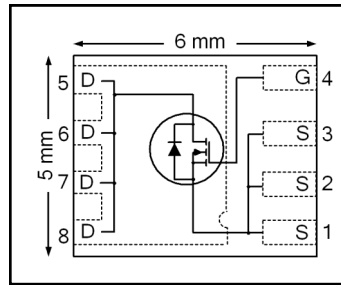


**Application**

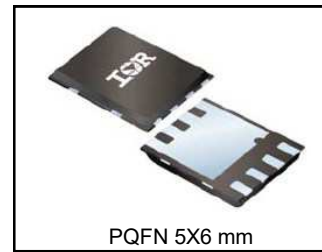
- Half-bridge and full-bridge topologies
- Synchronous rectifier applications
- Resonant mode power supplies
- DC/DC converters
- DC/AC Inverters



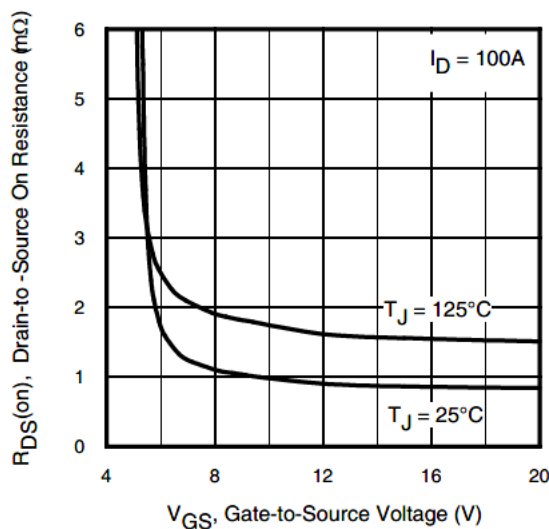
$V_{DSS}$	<b>40V</b>
$R_{DS(on)}$ typ.	<b>0.95mΩ</b>
	max
$I_D$	<b>265A</b>

**Benefits**

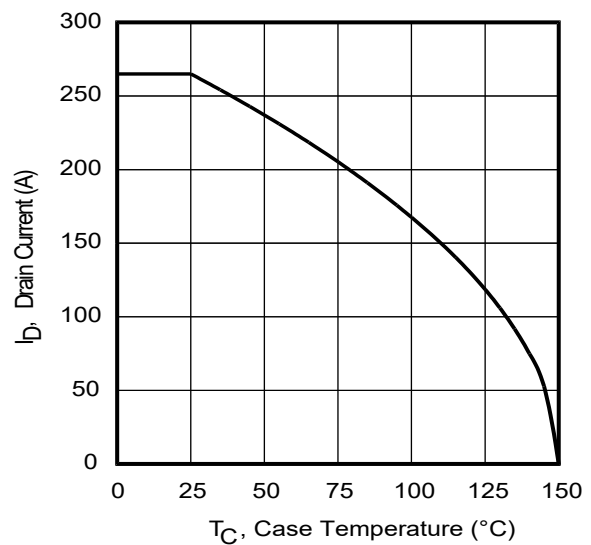
- Improved Gate, Avalanche and Dynamic dV/dt Ruggedness
- Fully Characterized Capacitance and Avalanche SOA
- Enhanced body diode dV/dt and dI/dt Capability
- Lead-Free, RoHS Compliant



Base part number	Package Type	Standard Pack		Orderable Part Number
		Form	Quantity	
IRFH7084PbF	PQFN 5mm x 6mm	Tape and Reel	4000	IRFH7084TRPbF



**Fig 1.** Typical On-Resistance vs. Gate Voltage



**Fig 2.** Maximum Drain Current vs. Case Temperature

**Absolute Maximum Rating**

Symbol	Parameter	Max.	Units
$I_D @ T_A = 25^\circ\text{C}$	Continuous Drain Current, $V_{GS} @ 10\text{V}$	40	A
$I_D @ T_{C(\text{Bottom})} = 25^\circ\text{C}$	Continuous Drain Current, $V_{GS} @ 10\text{V}^{\text{①}}$	265	
$I_D @ T_{C(\text{Bottom})} = 100^\circ\text{C}$	Continuous Drain Current, $V_{GS} @ 10\text{V}^{\text{①}}$	170	
$I_{DM}$	Pulsed Drain Current $^{\text{②}}$	1060	A
	Linear Derating Factor	1.25	$\text{W}/^\circ\text{C}$
$P_D @ T_C = 25^\circ\text{C}$	Max Power Dissipation	156	
$V_{GS}$	Gate-to-Source Voltage	$\pm 20$	V
$T_J$ $T_{STG}$	Operating Junction and Storage Temperature Range	-55 to + 150	$^\circ\text{C}$

**Avalanche Characteristics**

$E_{AS}$ (Thermally limited)	Single Pulse Avalanche Energy $^{\text{③}}$	185	mJ
$E_{AS}$ (Thermally limited)	Single Pulse Avalanche Energy $^{\text{④}}$	431	
$I_{AR}$	Avalanche Current $^{\text{②}}$	See Fig 14, 15, 23a,	A
$E_{AR}$	Repetitive Avalanche Energy $^{\text{②}}$	23b	mJ

**Thermal Resistance**

	Parameter	Typ.	Max.	Units
$R_{\theta JC}$ (Bottom)	Junction-to-Case $^{\text{⑤}}$	0.5	0.8	$^\circ\text{C}/\text{W}$
$R_{\theta JC}$ (Top)	Junction-to-Case $^{\text{⑤}}$	—	21	
$R_{\theta JA}$	Junction-to-Ambient $^{\text{⑥}}$	—	35	
$R_{\theta JA} (<10\text{s})$	Junction-to-Ambient	—	20	

**Static @  $T_J = 25^\circ\text{C}$  (unless otherwise specified)**

Symbol	Parameter	Min.	Typ.	Max.	Units	Conditions
$V_{(BR)DSS}$	Drain-to-Source Breakdown Voltage	40	—	—	V	$V_{GS} = 0\text{V}, I_D = 250\mu\text{A}$
$\Delta V_{(BR)DSS}/\Delta T_J$	Breakdown Voltage Temp. Coefficient	—	0.034	—	$\text{V}/^\circ\text{C}$	Reference to $25^\circ\text{C}, I_D = 1\text{mA}$
$R_{DS(\text{on})}$	Static Drain-to-Source On-Resistance	—	0.95	1.25	$\text{m}\Omega$	$V_{GS} = 10\text{V}, I_D = 100\text{A}$
$V_{GS(\text{th})}$	Gate Threshold Voltage	2.2	—	3.9	V	$V_{DS} = V_{GS}, I_D = 150\mu\text{A}$
$I_{DSS}$	Drain-to-Source Leakage Current	—	—	1.0	$\mu\text{A}$	$V_{DS} = 40\text{V}, V_{GS} = 0\text{V}$
		—	—	150		$V_{DS} = 40\text{V}, V_{GS} = 0\text{V}, T_J = 125^\circ\text{C}$
$I_{GSS}$	Gate-to-Source Forward Leakage	—	—	100	nA	$V_{GS} = 20\text{V}$
	Gate-to-Source Reverse Leakage	—	—	-100		$V_{GS} = -20\text{V}$
$R_G$	Gate Resistance	—	1.4	—	$\Omega$	

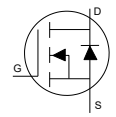
**Notes:**

- ① Rating refers to the product only with datasheet specified absolute maximum values, maintaining case temperature at  $25^\circ\text{C}$ . For higher case temperature please refer to Diagram 2. De-rating will be required based on the actual environmental conditions.
- ② Repetitive rating; pulse width limited by max. junction temperature.
- ③ Limited by  $T_{Jmax}$ , starting  $T_J = 25^\circ\text{C}$ ,  $L = 0.037\text{mH}$ ,  $R_G = 50\Omega$ ,  $I_{AS} = 100\text{A}$ ,  $V_{GS} = 10\text{V}$ .
- ④  $I_{SD} \leq 100\text{A}$ ,  $di/dt \leq 994\text{A}/\mu\text{s}$ ,  $V_{DD} \leq V_{(BR)DSS}$ ,  $T_J \leq 150^\circ\text{C}$ .
- ⑤ Pulse width  $\leq 400\mu\text{s}$ ; duty cycle  $\leq 2\%$ .
- ⑥  $C_{oss}$  eff. (TR) is a fixed capacitance that gives the same charging time as  $C_{oss}$  while  $V_{DS}$  is rising from 0 to 80%  $V_{DSS}$ .
- ⑦  $C_{oss}$  eff. (ER) is a fixed capacitance that gives the same energy as  $C_{oss}$  while  $V_{DS}$  is rising from 0 to 80%  $V_{DSS}$ .
- ⑧  $R_\theta$  is measured at  $T_J$  approximately  $90^\circ\text{C}$ .
- ⑨ Limited by  $T_{Jmax}$ , starting  $T_J = 25^\circ\text{C}$ ,  $L = 1\text{mH}$ ,  $R_G = 50\Omega$ ,  $I_{AS} = 29\text{A}$ ,  $V_{GS} = 10\text{V}$ .
- ⑩ When mounted on 1 inch square PCB (FR-4). Please refer to AN-994 for more details:  
<http://www.infineon.com/technical-info/appnotes/an-994.pdf>

**Dynamic Electrical Characteristics @ T<sub>J</sub> = 25°C (unless otherwise specified)**

Symbol	Parameter	Min.	Typ.	Max.	Units	Conditions
g <sub>fs</sub>	Forward Transconductance	120	—	—	S	V <sub>DS</sub> = 10V, I <sub>D</sub> = 100A
Q <sub>g</sub>	Total Gate Charge	—	127	190	nC	I <sub>D</sub> = 100A V <sub>DS</sub> = 20V V <sub>GS</sub> = 10V
Q <sub>gs</sub>	Gate-to-Source Charge	—	35	—		
Q <sub>gd</sub>	Gate-to-Drain Charge	—	41	—		
Q <sub>sync</sub>	Total Gate Charge Sync. (Q <sub>g</sub> – Q <sub>gd</sub> )	—	195	—		
t <sub>d(on)</sub>	Turn-On Delay Time	—	16	—	ns	V <sub>DD</sub> = 20V I <sub>D</sub> = 30A R <sub>G</sub> = 2.7Ω V <sub>GS</sub> = 10V <sup>⑤</sup>
t <sub>r</sub>	Rise Time	—	31	—		
t <sub>d(off)</sub>	Turn-Off Delay Time	—	64	—		
t <sub>f</sub>	Fall Time	—	34	—		
C <sub>iss</sub>	Input Capacitance	—	6560	—	pF	V <sub>GS</sub> = 0V V <sub>DS</sub> = 25V f = 1.0MHz, See Fig.5 V <sub>GS</sub> = 0V, V <sub>DS</sub> = 0V to 32V <sup>⑦</sup> See Fig.11 V <sub>GS</sub> = 0V, V <sub>DS</sub> = 0V to 32V <sup>⑧</sup>
C <sub>oss</sub>	Output Capacitance	—	940	—		
C <sub>rss</sub>	Reverse Transfer Capacitance	—	650	—		
C <sub>oss eff.(ER)</sub>	Effective Output Capacitance (Energy Related)	—	1120	—		
C <sub>oss eff.(TR)</sub>	Output Capacitance (Time Related)	—	1300	—		

**Diode Characteristics**

Symbol	Parameter	Min.	Typ.	Max.	Units	Conditions
I <sub>S</sub>	Continuous Source Current (Body Diode)	—	—	120	A	MOSFET symbol showing the integral reverse p-n junction diode. 
I <sub>SM</sub>	Pulsed Source Current (Body Diode) <sup>②</sup>	—	—	1060		
V <sub>SD</sub>	Diode Forward Voltage <sup>③</sup>	—	—	1.3	V	T <sub>J</sub> = 25°C, I <sub>S</sub> = 100A, V <sub>GS</sub> = 0V
dv/dt	Peak Diode Recovery dv/dt <sup>④</sup>	—	4.5	—	V/ns	T <sub>J</sub> = 150°C, I <sub>S</sub> = 100A, V <sub>DS</sub> = 40V
t <sub>rr</sub>	Reverse Recovery Time	—	36	—	ns	T <sub>J</sub> = 25°C V <sub>DD</sub> = 34V T <sub>J</sub> = 125°C I <sub>F</sub> = 100A,
Q <sub>rr</sub>	Reverse Recovery Charge	—	38	—		
I <sub>RRM</sub>	Reverse Recovery Current	—	1.7	—	A	T <sub>J</sub> = 25°C

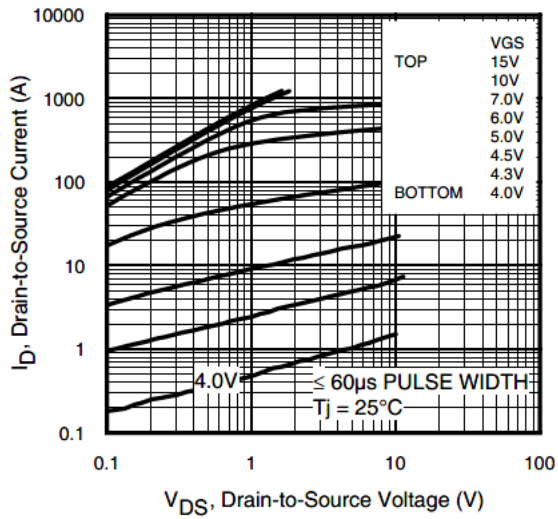


Fig 3. Typical Output Characteristics

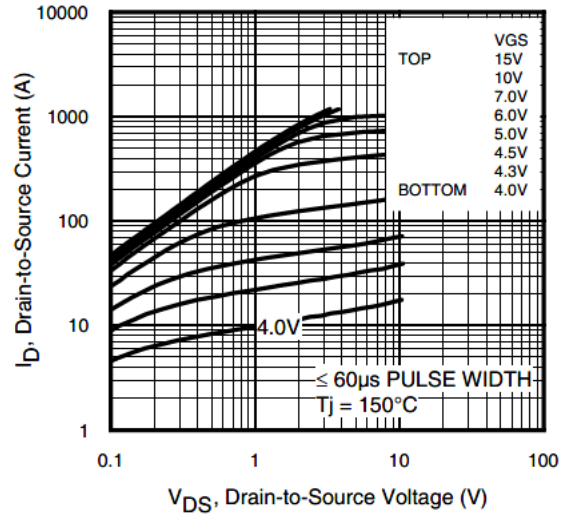


Fig 4. Typical Output Characteristics

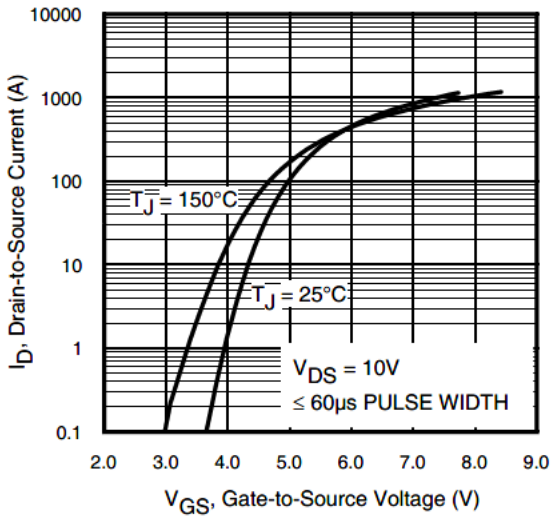


Fig 5. Typical Transfer Characteristics

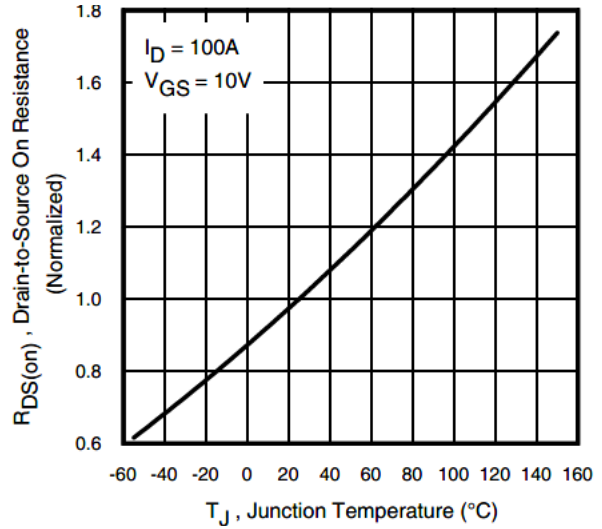


Fig 6. Normalized On-Resistance vs. Temperature

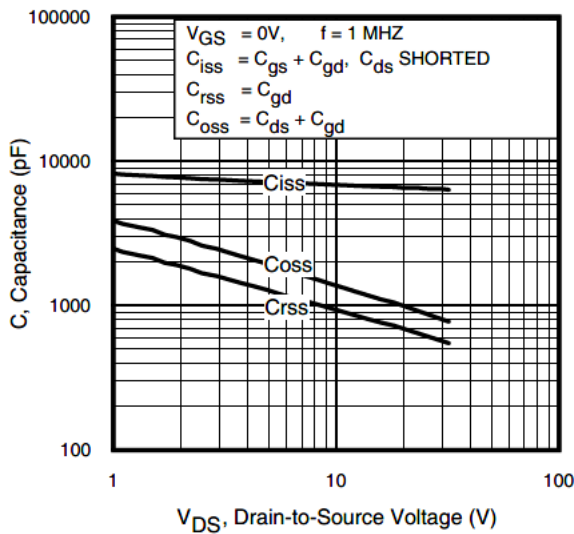


Fig 7. Typical Capacitance vs. Drain-to-Source Voltage

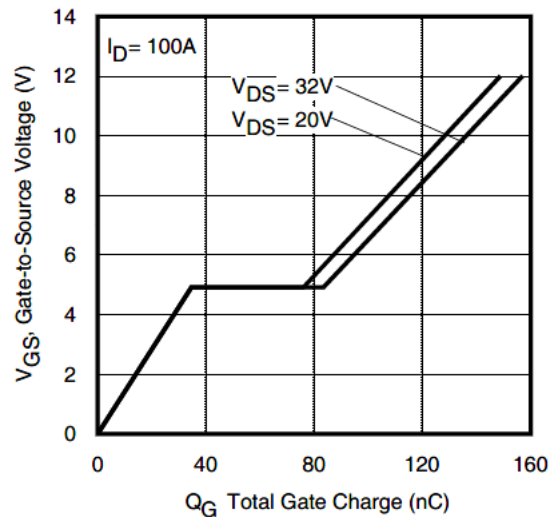


Fig 8. Typical Gate Charge vs. Gate-to-Source Voltage

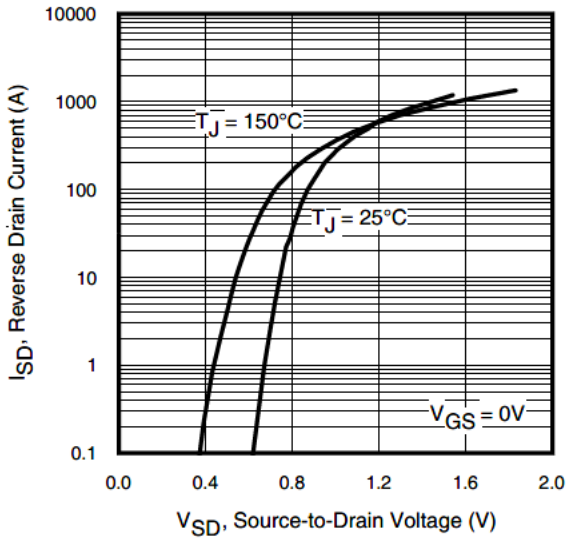


Fig 9. Typical Source-Drain Diode Forward Voltage

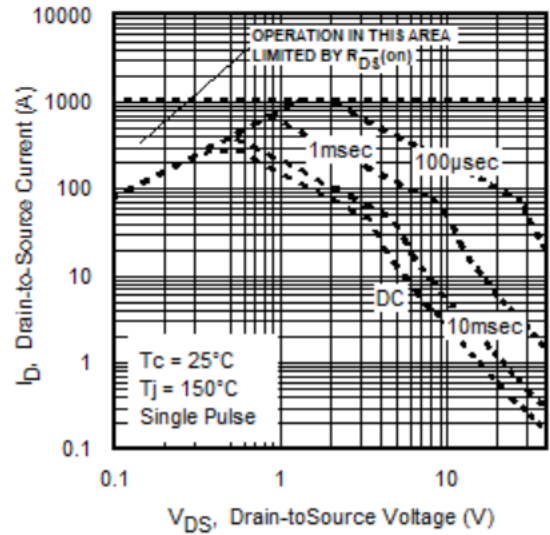


Fig 10. Maximum Safe Operating Area

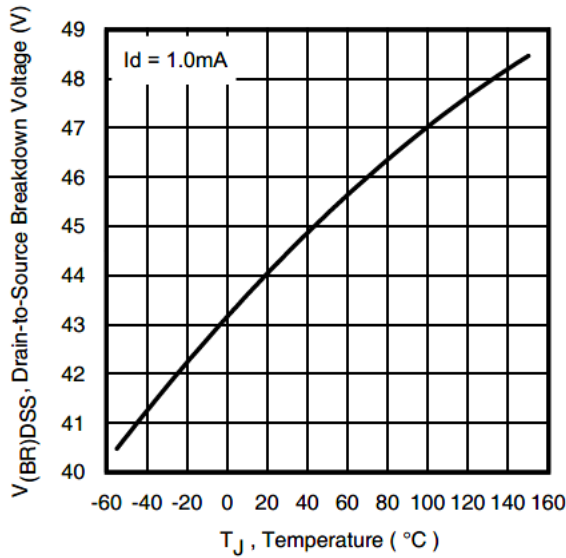


Fig 11. Drain-to-Source Breakdown Voltage

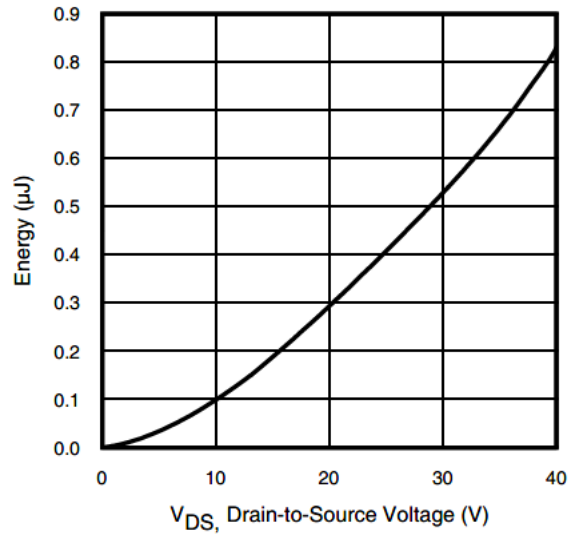


Fig 12. Typical  $C_{oss}$  Stored Energy

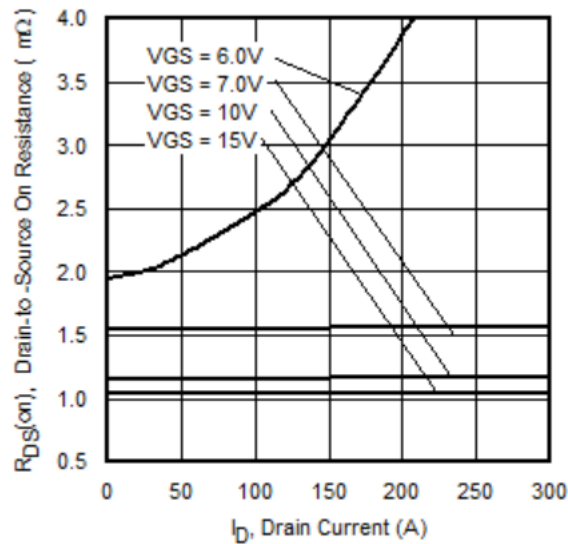
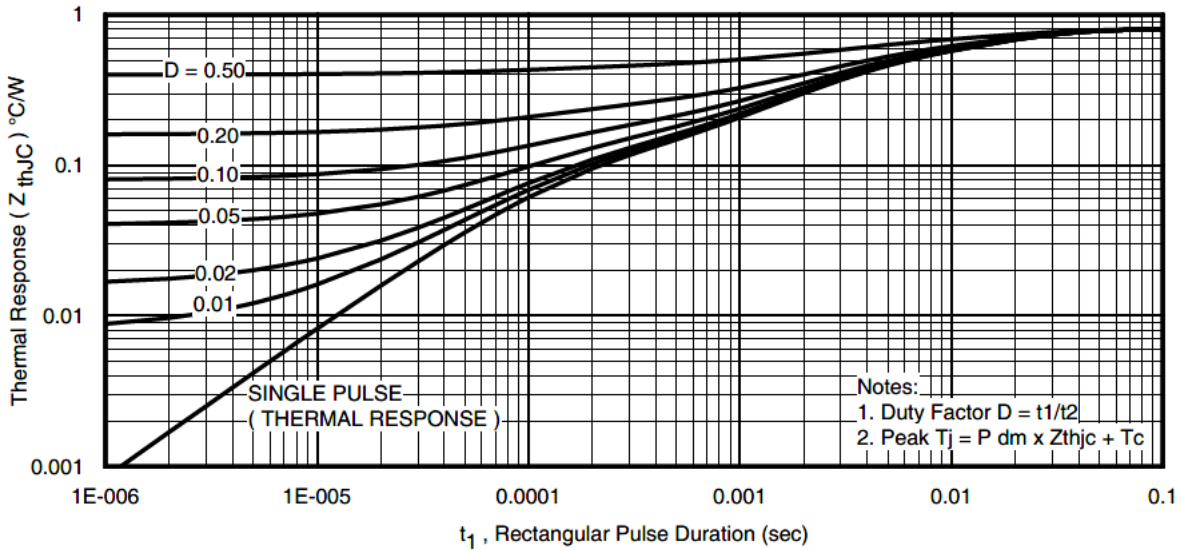
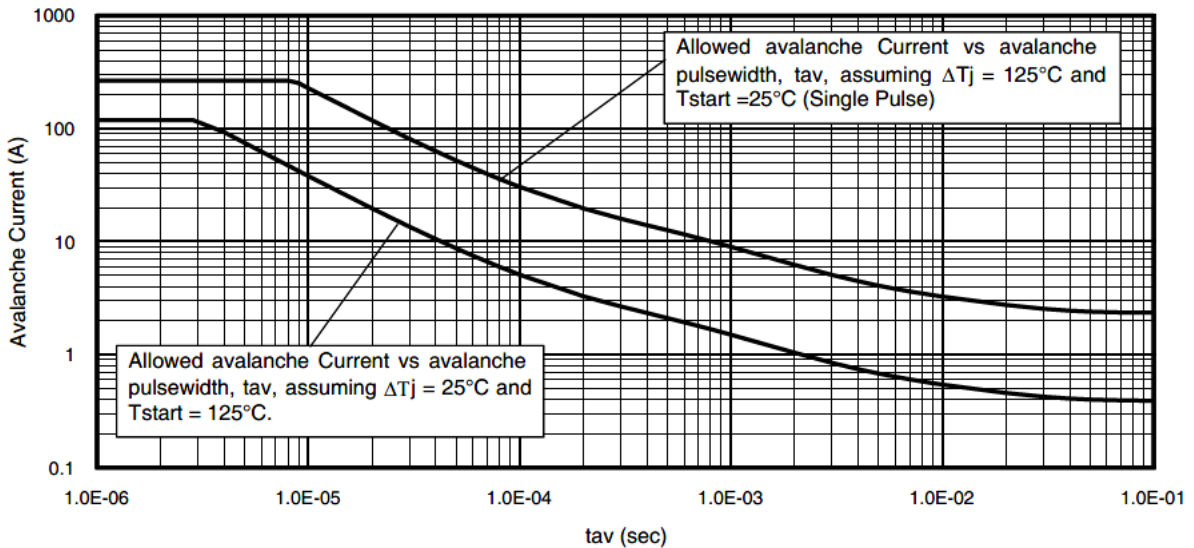
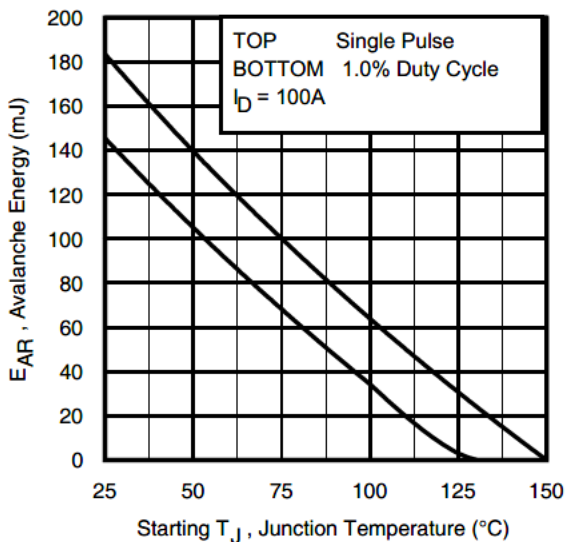


Fig 13. Typical On-Resistance vs. Drain Current


**Fig 14. Maximum Effective Transient Thermal Impedance, Junction-to-Case**

**Fig 15. Typical Avalanche Current vs. Pulse width**

**Fig 16. Maximum Avalanche Energy vs. Temperature**
**Notes on Repetitive Avalanche Curves , Figures 14, 15:  
(For further info, see AN-1005 at www.infineon.com)**

1. Avalanche failures assumption:  
Purely a thermal phenomenon and failure occurs at a temperature far in excess of  $T_{jmax}$ . This is validated for every part type.
2. Safe operation in Avalanche is allowed as long as  $T_{jmax}$  is not exceeded.
3. Equation below based on circuit and waveforms shown in Figures 22a, 22b.
4.  $P_{D(ave)}$  = Average power dissipation per single avalanche pulse.
5. BV = Rated breakdown voltage (1.3 factor accounts for voltage increase during avalanche).
6.  $I_{av}$  = Allowable avalanche current.
7.  $\Delta T$  = Allowable rise in junction temperature, not to exceed  $T_{jmax}$  (assumed as 25°C in Figure 14, 15).

 $t_{av}$  = Average time in avalanche.

 $D$  = Duty cycle in avalanche =  $t_{av} \cdot f$ 
 $Z_{thJC}(D, t_{av})$  = Transient thermal resistance, see Figures 13)

$$P_{D(ave)} = 1/2 ( 1.3 \cdot BV \cdot I_{av} ) = \Delta T / Z_{thJC}$$

$$I_{av} = 2\Delta T / [ 1.3 \cdot BV \cdot Z_{th} ]$$

$$E_{AS(AR)} = P_{D(ave)} \cdot t_{av}$$

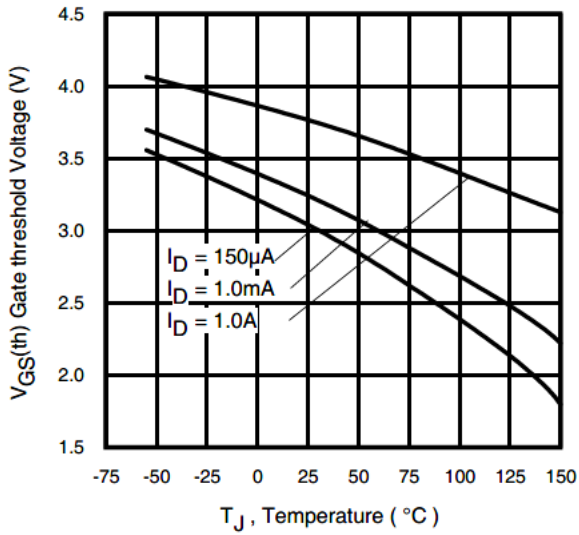


Fig 17. Threshold Voltage vs. Temperature

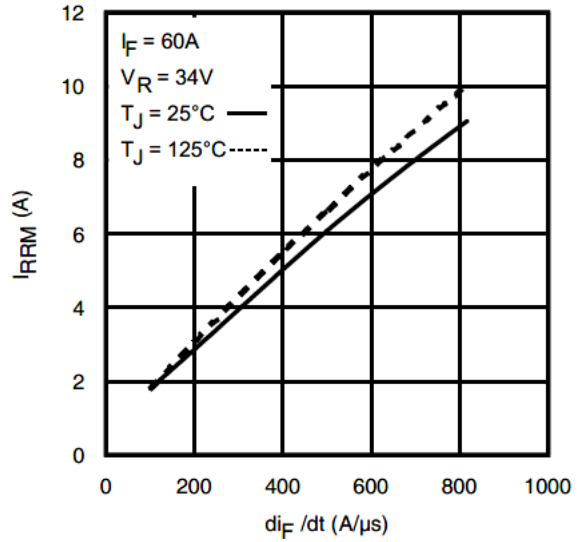


Fig 18. Typical Recovery Current vs. dif/dt

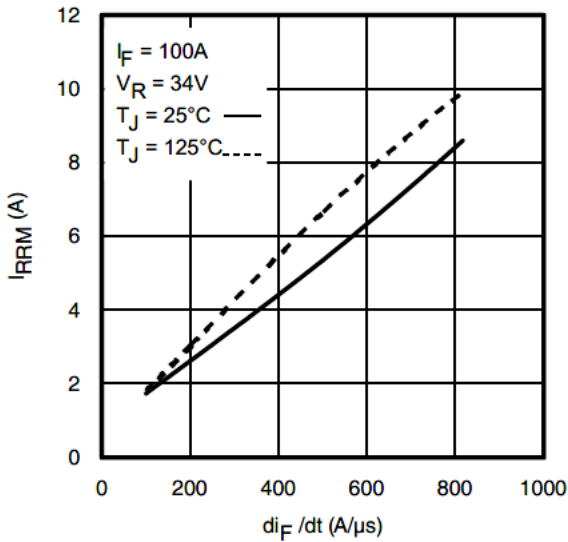


Fig 19. Typical Recovery Current vs. dif/dt

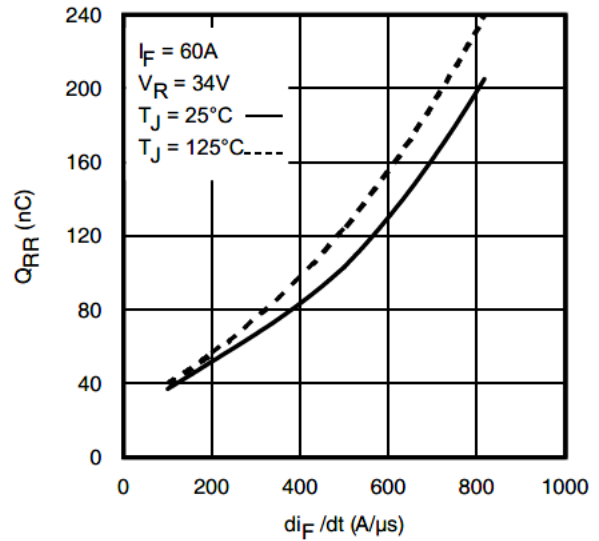


Fig 20. Typical Stored Charge vs. dif/dt

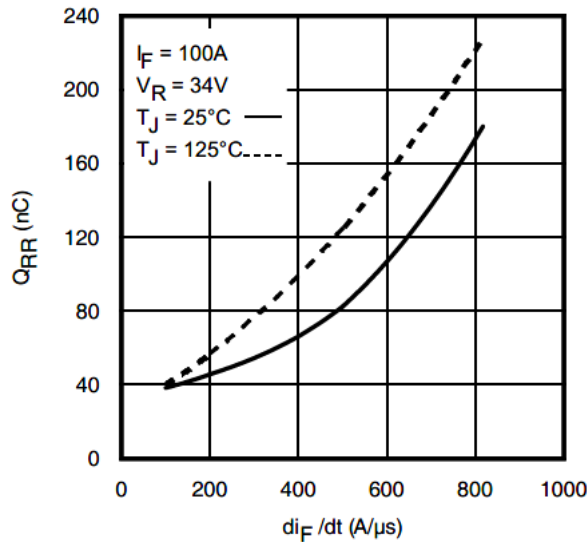
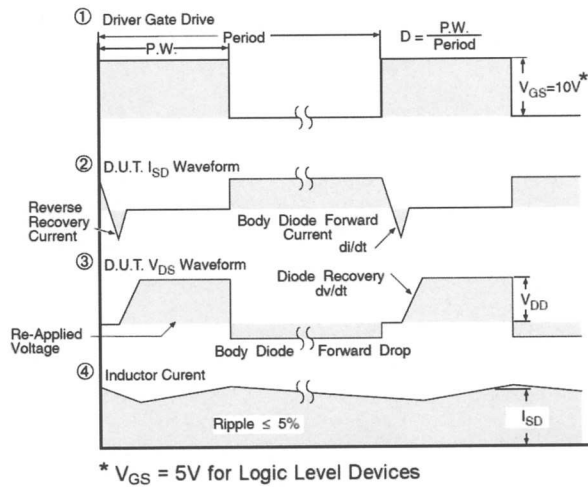
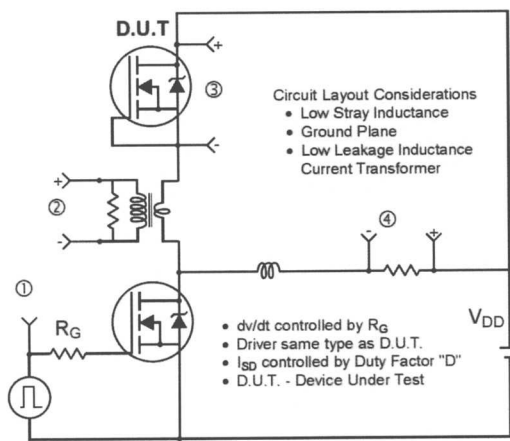
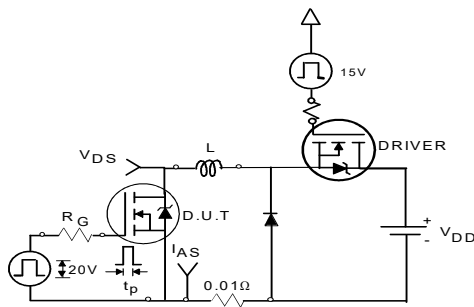


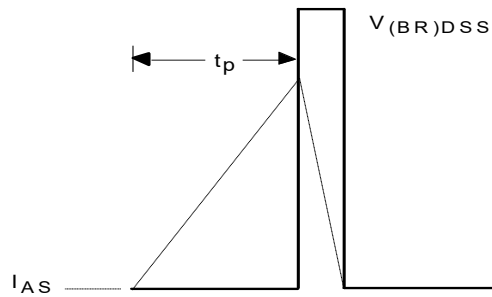
Fig 21. Typical Stored Charge vs. dif/dt



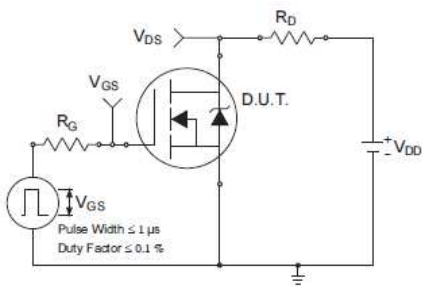
**Fig 22. Peak Diode Recovery dv/dt Test Circuit for N-Channel HEXFET® Power MOSFETs**



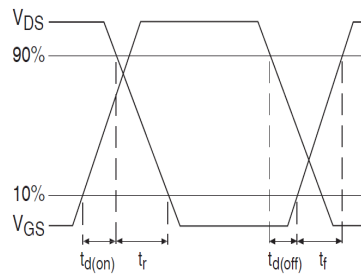
**Fig 23a. Unclamped Inductive Test Circuit**



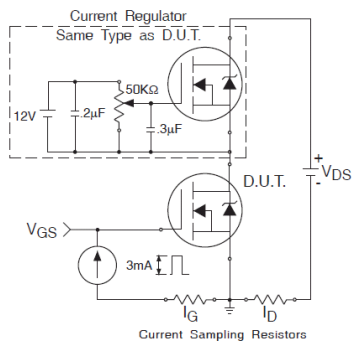
**Fig 23b. Unclamped Inductive Waveforms**



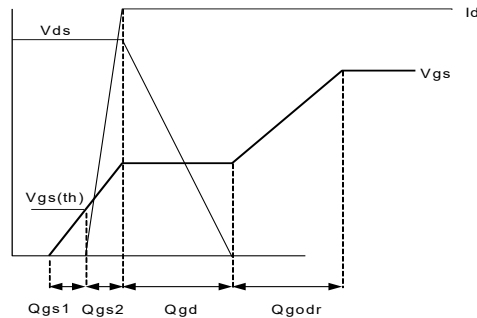
**Fig 24a. Switching Time Test Circuit**



**Fig 24b. Switching Time Waveforms**

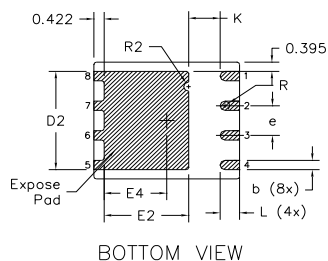
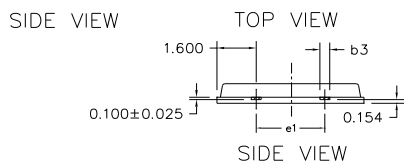
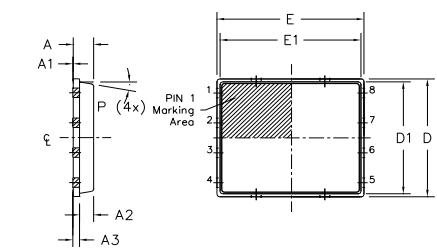


**Fig 25a. Gate Charge Test Circuit**



**Fig 25b. Gate Charge Waveform**

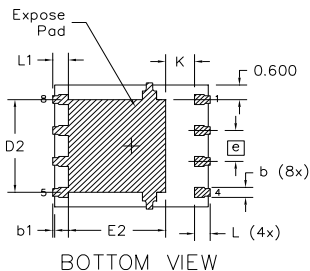
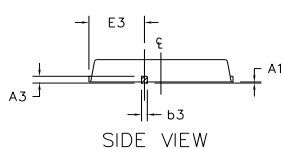
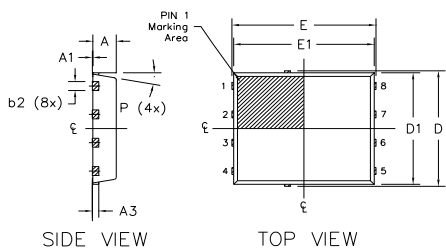


**PQFN 5x6 Outline "B" Package Details**


DIM SYMBOL	MILLIMETERS		INCH	
	MIN	MAX	MIN	MAX
A	0.800	0.900	0.0315	0.0543
A1	0.000	0.050	0.0000	0.0020
A3	0.200 REF		0.0079 REF	
b	0.350	0.470	0.0138	0.0185
b1	0.025	0.125	0.0010	0.0049
b2	0.210	0.410	0.0083	0.0161
b3	0.150	0.450	0.0059	0.0177
D	5.000 BSC		0.1969 BSC	
D1	4.750 BSC		0.1870 BSC	
D2	4.100	4.300	0.1614	0.1693
E	6.000 BSC		0.2362 BSC	
E1	5.750 BSC		0.2264 BSC	
E2	3.380	3.780	0.1331	0.1488
e	1.270 REF		0.0500 REF	
e1	2.800 REF		0.1102 REF	
K	1.200	1.420	0.0472	0.0559
L	0.710	0.900	0.0280	0.0354
P	0°	12°	0°	12°
R	0.200 REF		0.0079 REF	
R2	0.150	0.200	0.0059	0.0079

**Note:**

1. Dimensions and tolerancing confirm to ASME Y14.5M-1994
2. Dimension L represents terminal full back from package edge up to 0.1mm is acceptable
3. Coplanarity applies to the expose Heat Slug as well as the terminal
4. Radius on terminal is Optional

**PQFN 5x6 Outline "G" Package Details**


DIM SYMBOL	MILLIMETERS		INCH	
	MIN.	MAX.	MIN.	MAX.
A	0.950	1.050	0.0374	0.0413
A1	0.000	0.050	0.0000	0.0020
A3	0.254 REF		0.0100 REF	
b	0.310	0.510	0.0122	0.0201
b1	0.025	0.125	0.0010	0.0049
b2	0.210	0.410	0.0083	0.0161
b3	0.180	0.450	0.0071	0.0177
D	5.150 BSC		0.2028 BSC	
D1	5.000 BSC		0.1969 BSC	
D2	3.700	3.900	0.1457	0.1535
E	6.150 BSC		0.2421 BSC	
E1	6.000 BSC		0.2362 BSC	
E2	3.560	3.760	0.1402	0.1488
E3	2.270	2.470	0.0894	0.0972
e	1.27 REF		0.050 REF	
K	0.830	1.400	0.0327	0.0551
L	0.510	0.710	0.0201	0.0280
L1	0.510	0.710	0.0201	0.0280
P	10 deg	12 deg	0 deg	12 deg

**Note:**

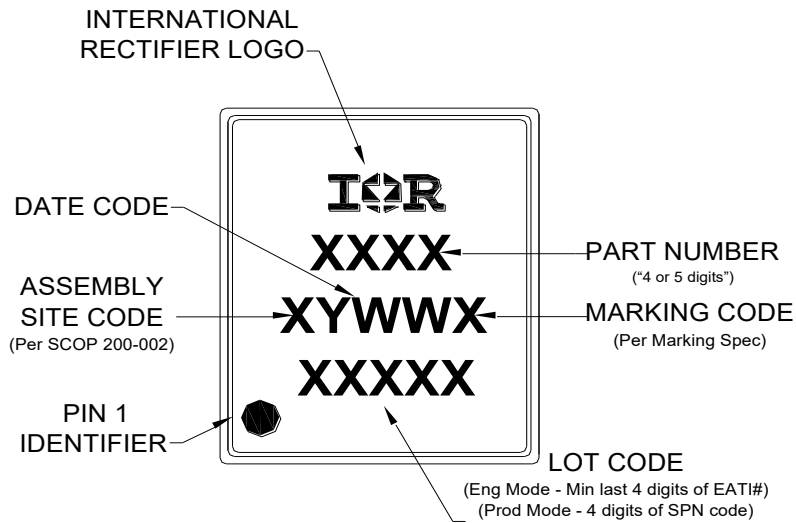
1. Dimensions and tolerancing confirm to ASME Y14.5M-1994
2. Dimension L represents terminal full back from package edge up to 0.1mm is acceptable
3. Coplanarity applies to the expose Heat Slug as well as the terminal
4. Radius on terminal is Optional

For more information on board mounting, including footprint and stencil recommendation, please refer to application note AN-1136: <http://www.infineon.com/technical-info/appnotes/an-1136.pdf>

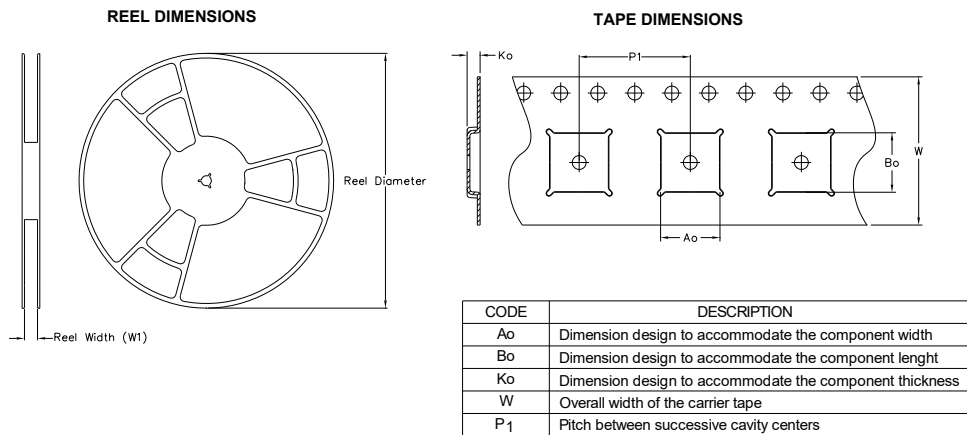
For more information on package inspection techniques, please refer to application note AN-1154: <http://www.infineon.com/technical-info/appnotes/an-1154.pdf>

Note: For the most current drawing please refer to IR website at <http://www.infineon.com/package/>

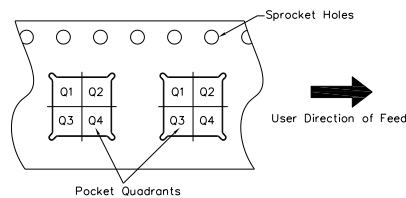
PQFN 5x6 Part Marking



PQFN 5x6 Tape and Reel



QUADRANT ASSIGNMENTS FOR PIN 1 ORIENTATION IN TAPE



Note: All dimension are nominal

Package Type	Reel Diameter (Inch)	QTY	Reel Width W1 (mm)	Ao (mm)	Bo (mm)	Ko (mm)	P1 (mm)	W (mm)	Pin 1 Quadrant
5 X 6 PQFN	13	4000	12.4	6.300	5.300	1.20	8.00	12	Q1

Note: For the most current drawing please refer to IR website at <http://www.infineon.com/package/>

**Qualification information<sup>†</sup>**

Qualification level	Industrial <sup>††</sup>	
	(per JEDEC JESD47F <sup>††</sup> guidelines )	
Moisture Sensitivity Level	PQFN 5mmx 6mm	MSL1 (per JEDEC J-STD-020D <sup>††</sup> )
RoHS compliant	Yes	

† Qualification standards can be found at International Rectifier's web site: <http://www.infineon.com/product-info/reliability/>

†† Applicable version of JEDEC standard at the time of product release.

**Revision History**

Date	Rev.	Comments
10/16/2014	2.1	<ul style="list-style-type: none"> <li>Add Pd at tc=25C on Absolute Max Rating table on page 2</li> </ul>
03/05/2015	2.2	<ul style="list-style-type: none"> <li>Updated E<sub>AS</sub> (L=1mH) = 431mJ on page 2</li> <li>Updated note 8 "Limited by T<sub>Jmax</sub>, starting T<sub>J</sub> = 25°C, L = 1mH, R<sub>G</sub> = 50Ω, I<sub>AS</sub> = 29A, V<sub>GS</sub> = 10V" on page 2</li> </ul>
03/19/2015	2.3	<ul style="list-style-type: none"> <li>Updated package outline on page 9.</li> </ul>
01/24/2017	2.4	<ul style="list-style-type: none"> <li>Changed datasheet with Infineon logo - all pages</li> <li>Added package outline for "option G" on page 9.</li> <li>Added disclaimer on last page</li> </ul>
4/14/2020	2.5	<ul style="list-style-type: none"> <li>Updated datasheet based on IFX template.</li> <li>Updated Datasheet based on new current rating and application note :App-AN_1912_PL51_2001_180356</li> </ul>

**Trademarks**

All referenced product or service names and trademarks are the property of their respective owners.

**We Listen to Your Comments**

Any information within this document that you feel is wrong, unclear or missing at all? Your feedback will help us to continuously improve the quality of this document. Please send your proposal (including a reference to this document) to:

[erratum@infineon.com](mailto:erratum@infineon.com)

**Published by**

**Infineon Technologies AG**

**81726 München, Germany**

**© 2020 Infineon Technologies AG**

**All Rights Reserved.**

**Legal Disclaimer**

The information given in this document shall in no event be regarded as a guarantee of conditions or characteristics ("Beschaffenheitsgarantie").

With respect to any examples, hints or any typical values stated herein and/or any information regarding the application of the product, Infineon Technologies hereby disclaims any and all warranties and liabilities of any kind, including without limitation warranties of non-infringement of intellectual property rights of any third party.

In addition, any information given in this document is subject to customer's compliance with its obligations stated in this document and any applicable legal requirements, norms and standards concerning customer's products and any use of the product of Infineon Technologies in customer's applications.

The data contained in this document is exclusively intended for technically trained staff. It is the responsibility of customer's technical departments to evaluate the suitability of the product for the intended application and the completeness of the product information given in this document with respect to such application.

**Information**

For further information on technology, delivery terms and conditions and prices please contact your nearest Infineon Technologies Office ([www.infineon.com](http://www.infineon.com)).

**Warnings**

Due to technical requirements, components may contain dangerous substances. For information on the types in question, please contact the nearest Infineon Technologies Office.

The Infineon Technologies component described in this Data Sheet may be used in life-support devices or systems and/or automotive, aviation and aerospace applications or systems only with the express written approval of Infineon Technologies, if a failure of such components can reasonably be expected to cause the failure of that life-support, automotive, aviation and aerospace device or system or to affect the safety or effectiveness of that device or system. Life support devices or systems are intended to be implanted in the human body or to support and/or maintain and sustain and/or protect human life. If they fail, it is reasonable to assume that the health of the user or other persons may be endangered.

# Mouser Electronics

Authorized Distributor

Click to View Pricing, Inventory, Delivery & Lifecycle Information:

[Infineon:](#)

[IRFH7084TRPBF](#)