

MSR127 Minotaur Monitoring Safety Relays

Catalog Number 440R-N23124, 440R-N23125, 440R-N23126, 440R-N23127, 440R-N23128, 440R-N23129, 440R-N23129M, 440R-N23130, 440R-N23131, 440R-N23132, 440R-N23132S, 440R-N23133, 440R-N23134, 440R-N23135, 440R-N23135M, 440R-N23135S, 440R-N23213

Topic	Page
Summary of Changes	1
Safety	1
Declaration of Conformity	1
Functional Description	1
Diagnostics	1
Safety Input	2
Reset	2
Wiring Examples	2
Circuit Diagram	2
Approximate Dimensions	3
Installation	3
Safety Specification	3
Technical Specifications	3

Summary of Changes

This publication contains the following new or updated information. This list includes substantive updates only and is not intended to reflect all changes. Translated versions are not always available for each revision.

Topic	Page
Updated title of publication	1
Updated Declaration of Conformity section	1
Updated Positive Edge section	2
Updated Circuit Diagram section	2
Updated Safety Specification section	3

Safety

This device is intended to be part of the safety-related control system of a machine.

Safety Notes

Before installation, a risk assessment must be performed to determine whether the specifications of this device are suitable for all foreseeable operational and environmental characteristics of the machine to which it is to be fitted. At regular intervals during the life of the machine, check whether the characteristics foreseen remain valid.



- ATTENTION:** Danger of serious injuries. Misuse can result in malfunction.
- Only authorized and trained personnel must start up, assemble, install, manipulate, or retrofit the device.
 - Installation must be in accordance with these instructions.
 - Do not defeat, tamper, remove, or bypass this unit.

Rockwell Automation cannot accept responsibility for failure of this device if the procedures given in these instructions are not followed or if it is used outside the recommended specifications in these instructions.

IMPORTANT The safety inputs of these products are described as normally closed (N.C.), that is, with the guard closed, actuator in place (where relevant) and the machine able to be started. Exposure to shock and/or vibration in excess of what is stated in IEC 60068 part: 2-6/7 must be avoided. Adherence to the recommended inspection and maintenance instructions forms part of the warranty.

Repair



ATTENTION: MSR127 safety relays are not repairable.

If there is any malfunction or damage, do not attempt to repair. The unit must be replaced before machine operation is allowed.

Declaration of Conformity

CE Rockwell Automation declares that all MSR127 safety relays are in conformity with Directives 2014/30/EU, 2006/42/EC, 2011/65/EU as specified in the Declaration of Conformity available from rok.auto/certifications.

Functional Description

The unit is enabled once supply is powered up and the safety circuits are closed. The PWR status indicator is on.

A valid reset operation activates the safety outputs. The CH1 and CH2 status indicators of the output are lit. At demand of the safety function and if any fault, the safety outputs are de-energized within the specified response time.

Fault Detection

If a fault occurs, the internal relay circuit forces the safety outputs off. One or both output status indicators may be off. The PWR indicator may be flashing. Remove the fault and cycle the safety input to re-enable the device. Cycling power to the safety relay can also clear the fault condition.

Diagnostics

Auxiliary (N.C.) outputs 41...42 monitor the safety output state.

Safety Input

The safety input can be single channel or dual channel. According to the wiring inputs, cross-loop monitoring of the inputs is enabled or disabled. Cross-loop monitoring can be enabled for 2-channel safety inputs in 4-wire connection S11-S12, S21-S22. Cross-loop monitoring is disabled for single-channel inputs, dual-channel inputs in 3-wire connection and 24V DC signals. With external 24V DC signals, the negative pole must be connected to S21.

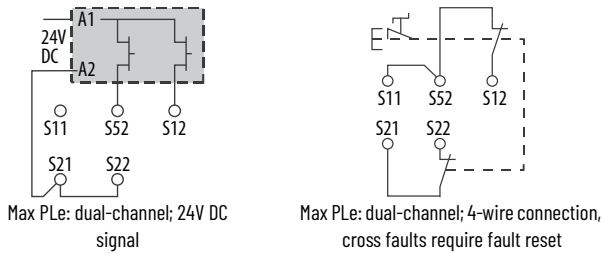
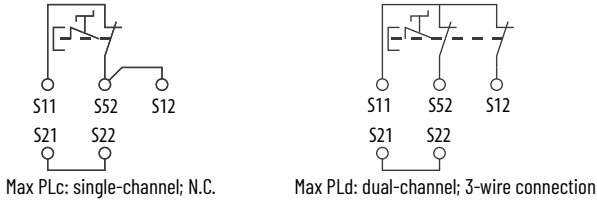

Reset

Reset modes — Unit is available with automatic/manual start (MSR127T/TP) and manual monitored reset (MSR127R/RP).

A valid start/reset can only be operated if the feedback circuit is closed. Feedback contacts of controlled actuators are connected in series with start/reset circuit (S12-S34).

T - Automatic/manual Start

In automatic/manual start mode, the reset circuit S12-S34 is not monitored against signal changes (no edge detection). The reset circuit can be closed before or after the safety inputs are closed. Unit is active once the safety inputs are closed and the reset circuit has been closed. If the safety inputs and reset circuit are concurrently closed during powerup, unit is activated immediately.

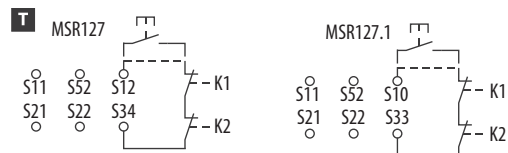

R - Manual Monitored Reset

In manual monitored reset mode, a signal change of the reset circuit (S12-S34) is required and monitored. The reset circuit must be closed after the safety inputs are closed.

R Positive Edge

Unit is active once the safety inputs are closed and then the reset circuit is closed.

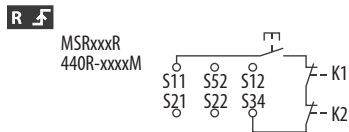

Wiring Examples

Figure 1 - Dual-channel Safety Gates, Monitored Manual Reset, Monitored Output

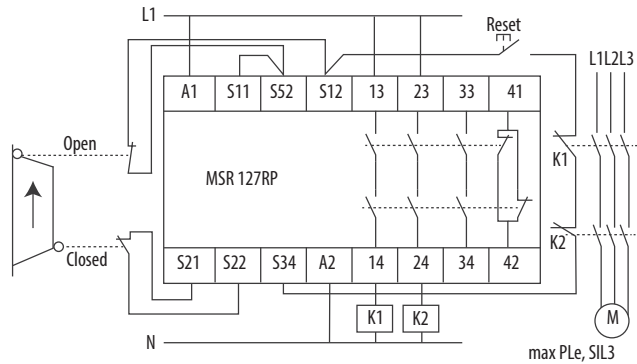
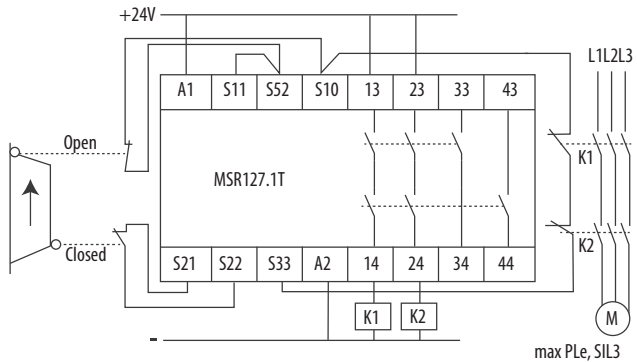

Figure 2 - Dual-channel Safety Gates, Auto Reset, Monitored Output



Circuit Diagram

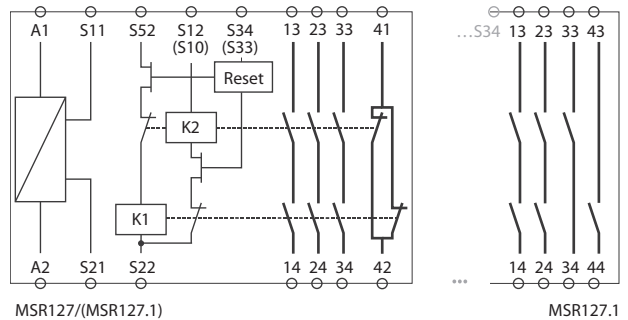

Table 1 - Connections

Terminal	Description
A1, A2	Power
S11, S12 (S10), S52, S21, S22	Safety input (N.C.)
S34 (S33)	Monitoring feedback loop with Reset button
MSR127R, MSR127T, MSR127RP, MSR127TP	
13, 14, 23, 24, 33, 34	Safety output (N.O.)
41, 42	Auxiliary output (N.C.)
MSR127.1T	
13, 14, 23, 24	Safety output (N.O.)
33, 34, 43, 44	Auxiliary output (N.O.)

Approximate Dimensions

Figure 3 - Dimensions [mm (in.)]

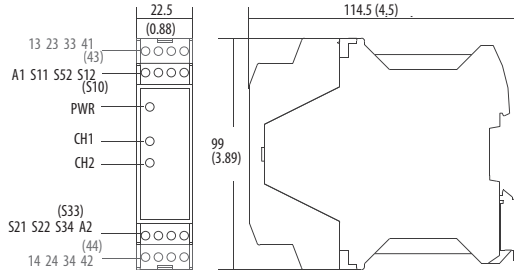
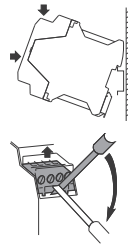

Table 2 - Status Indicators

Status Indicator	Description
PWR	Green = Unit is powered. Flashing green = Cross-loop faults.
CH1	Green = Safety output channel 1 is activated.
CH2	Green = Safety output channel 2 is activated.

Installation

- Mount in enclosure (minimum rating of IP54).
- To remove terminals (P versions only), insert a screwdriver and slowly move as shown.



Safety Specification

All MSR127 safety relays can be used in safety circuits according to EN ISO 13849-1 and IEC 61508/IEC 62061.

Specifications are applicable only if the safety function is demanded at least once within 6 months. All diagnostic tests are conducted at least before next demand. The mission time (TM) for the proof test interval (PTI) is adopted.

Components failure rates according to SN29500.

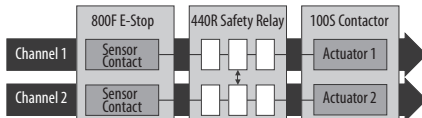

Attribute	Value
TM (PTI) [a]	20
dop [d] / hop [h] ⁽¹⁾	365 / 24
tcycle [h]/[s] ⁽²⁾	8 / 28,800

(1) Operation time (day, hour)

(2) Cycle time (hour, second)

Table 3 - Safety Specification

EN ISO 13849-1		IEC 61508/IEC 62061	
Performance Level	PLe	Safety integrity level	SIL 3
MTTFd [a]	378	PFH [1/h]	1.94E-09
Cat.	4	HFT	1
DC avg.	99%	DC	99%

Technical Specifications

Attribute	Value	
Power supply	24V AC/DC, 115V AC, 230V AC 0.85...1.1 x rated voltage 50/60 Hz	
Power consumption	2 W	
Safety inputs	1 N.C., 2 N.C., 2 PNP light curtain	
Input simultaneity	Infinite	
Allowable input resistance, max	110 Ω	
Reset	Manual monitored and automatic/manual	
Outputs	MSR127RP/TP	3 N.O. safety, 1 N.C. auxiliary
	MSR127.IT	2 N.O. safety, 2 N.O. auxiliary
Output rating	UL: B300 5 A/240V AC AC-15: 5 A/250V AC DC-13: 3 A/24V DC	
Fuses output (external)	6 A slow blow or 10 A quick blow	
Switched current/voltage, min	10 mA/10 V	
Contact material	AgSnO ₂ + 0.5μAu	
Electrical life (operations)	100,000 (220V AC/4 A/880VA cosφ = 0.35) 500,000 (220V AC/1.7 A/375VA cosφ = 0.6) 1,000,000 (30V DC/2 A/60 W) 2,000,000 (10V DC/0.01 A/0.1 W)	
Mechanical life	10,000,000 cycles	
Power on delay	1 s	
Response time	15 ms	
Recovery time	100 ms	
Impulse withstand voltage	2500V	
Pollution degree	2	
Installation group	Overvoltage category III, VDE 0110-1	
Operating temperature	-5...+55 °C (23...131 °F)	
Relative humidity	90%	
Enclosure protection	IP40 (NEMA 1)	
Terminal protection	IP20	
Wiring	Use copper that withstands 60/75 °C (140/167 °F)	
Conductor size	0.2...2.5 mm ² (24...12 AWG)	
Torque settings - terminal screws	0.6...0.8 N•m (5...7 lb•in)	
Case material	Polyamide PA 6.6	
Mounting	35 mm (1.4 in.) DIN rail in IP54 (min) enclosure	
Weight	24V AC/DC: 210 g (0.463 lb) 115V AC or 230V AC: 260 g (0.573 lb)	
Vibration	10...55 Hz, 0.35 mm (0.01 in.)	

Waste Electrical and Electronic Equipment (WEEE)







At the end of life, this equipment should be collected separately from any unsorted municipal waste.

Rockwell Automation maintains current product environmental information on its website at rok.auto/pec.

Your comments help us serve your documentation needs better. If you have any suggestions on how to improve our content, complete the form at rok.auto/docfeedback.
For technical support, visit rok.auto/support.

Rockwell Otomasyon Ticaret A.Ş. Kar Plaza İş Merkezi E Blok Kat:6 34752 İçerenköy, İstanbul, Tel: +90 (216) 5698400 EEE Yönetmeliğine Uygundur

Connect with us.    

rockwellautomation.com

expanding **human possibility**[™]

AMERICAS: Rockwell Automation, 1201 South Second Street, Milwaukee, WI 53204-2496 USA, Tel: (1) 414.382.2000, Fax: (1) 414.382.4444

EUROPE/MIDDLE EAST/AFRICA: Rockwell Automation NV, Pegasus Park, De Kleetlaan 12a, 1831 Diegem, Belgium, Tel: (32) 2 663 0600, Fax: (32) 2 663 0640

ASIA PACIFIC: Rockwell Automation, Level 14, Core F, Cyberport 3, 100 Cyberport Road, Hong Kong, Tel: (852) 2887 4788, Fax: (852) 2508 1846

Allen-Bradley, expanding human possibility, Minotaur, Rockwell Automation, and Rockwell Software are trademarks of Rockwell Automation, Inc.
Trademarks not belonging to Rockwell Automation are property of their respective companies.

Publication 440R-IN079C-EN-P - May 2020 | Supersedes Publication 440R-IN079B-EN-P-March 2020
Copyright © 2020 Rockwell Automation, Inc. All rights reserved. Printed in the U.S.A.



PN-387541

PN-387541
95302166 Ver 08