

# Automotive-grade silicon carbide Power MOSFET, 650 V, 55 mΩ typ., 45 A in an H<sup>2</sup>PAK-7 package

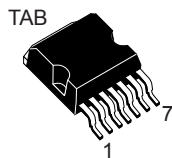

**H<sup>2</sup>PAK-7**

N-chG1DS2PS34567DTAB

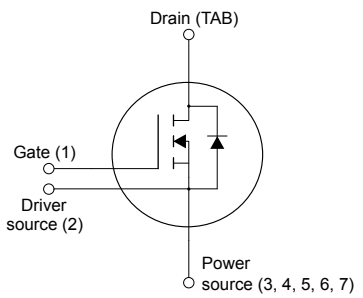

## Features

Order code	V <sub>DS</sub>	R <sub>DS(on)</sub> max.	I <sub>D</sub>
SCTH35N65G2V-7AG	650 V	67 mΩ	45 A

- AEC-Q101 qualified 
- Very fast and robust intrinsic body diode
- Extremely low gate charge and input capacitance
- Source sensing pin for increased efficiency

## Applications

- Main inverter (electric traction)
- DC/DC converter for EV/HEV
- On board charger (OBC)

## Description

This silicon carbide Power MOSFET device has been developed using ST's advanced and innovative 2<sup>nd</sup> generation SiC MOSFET technology. The device features remarkably low on-resistance per unit area and very good switching performance. The variation of switching loss is almost independent of junction temperature.

### Product status link

[SCTH35N65G2V-7AG](#)

### Product summary

<b>Order code</b>	SCTH35N65G2V-7AG
<b>Marking</b>	35N65AG
<b>Package</b>	H <sup>2</sup> PAK-7
<b>Packing</b>	Tape and reel

# 1 Electrical ratings

**Table 1. Absolute maximum ratings**

Symbol	Parameter	Value	Unit
$V_{DS}$	Drain-source voltage	650	V
$V_{GS}$	Gate-source voltage	-10 to 22	V
	Gate-source voltage (recommended operating range)	-5 to 18	
$I_D$	Drain current (continuous) at $T_C = 25\text{ °C}$	45	A
	Drain current (continuous) at $T_C = 100\text{ °C}$	35	
$I_{DM}^{(1)}$	Drain current (pulsed)	90	A
$P_{TOT}$	Total power dissipation at $T_C = 25\text{ °C}$	208	W
$T_{stg}$	Storage temperature range	-55 to 175	°C
$T_J$	Operating junction temperature range		°C

1. Pulse width is limited by safe operating area.

**Table 2. Thermal data**

Symbol	Parameter	Value	Unit
$R_{thJC}$	Thermal resistance, junction-to-case	0.72	°C/W
$R_{thJA}$	Thermal resistance, junction-to-ambient	62.5	°C/W

## 2 Electrical characteristics

( $T_C = 25\text{ °C}$  unless otherwise specified)

**Table 3. On/off states**

Symbol	Parameter	Test conditions	Min.	Typ.	Max.	Unit
$V_{(BR)DSS}$	Drain-source breakdown voltage	$V_{GS} = 0\text{ V}$ , $I_D = 1\text{ mA}$	650			V
$I_{DSS}$	Zero gate voltage drain current	$V_{GS} = 0\text{ V}$ , $V_{DS} = 650\text{ V}$			5	$\mu\text{A}$
$I_{GSS}$	Gate-body leakage current	$V_{DS} = 0\text{ V}$ , $V_{GS} = -10\text{ to }22\text{ V}$			$\pm 100$	nA
$V_{GS(th)}$	Gate threshold voltage	$V_{DS} = V_{GS}$ , $I_D = 1\text{ mA}$	1.8	3.2	5	V
$R_{DS(on)}$	Static drain-source on-resistance	$V_{GS} = 20\text{ V}$ , $I_D = 20\text{ A}$		45	67	m $\Omega$
		$V_{GS} = 18\text{ V}$ , $I_D = 20\text{ A}$		55		
		$V_{GS} = 20\text{ V}$ , $I_D = 20\text{ A}$ , $T_J = 175\text{ °C}$		65		

**Table 4. Dynamic, based on HiP247 package option**

Symbol	Parameter	Test conditions	Min.	Typ.	Max.	Unit
$C_{iss}$	Input capacitance	$V_{DS} = 400\text{ V}$ , $f = 1\text{ MHz}$ , $V_{GS} = 0\text{ V}$	-	1370	-	pF
$C_{oss}$	Output capacitance		-	125	-	pF
$C_{riss}$	Reverse transfer capacitance		-	30	-	pF
$Q_g$	Total gate charge	$V_{DD} = 400\text{ V}$ , $V_{GS} = 0\text{ to }20\text{ V}$ , $I_D = 20\text{ A}$	-	73	-	nC
$Q_{gs}$	Gate-source charge		-	14	-	nC
$Q_{gd}$	Gate-drain charge		-	27	-	nC
$R_g$	Gate input resistance	$f = 1\text{ MHz}$ , $I_D = 0\text{ A}$	-	2	-	$\Omega$

**Table 5. Switching energy (inductive load), based on HiP247 package option**

Symbol	Parameter	Test conditions	Min.	Typ.	Max.	Unit
$E_{on}$	Turn-on switching energy	$V_{DD} = 400\text{ V}$ , $I_D = 20\text{ A}$	-	100	-	$\mu\text{J}$
$E_{off}$	Turn-off switching energy	$R_G = 10\text{ }\Omega$ , $V_{GS} = -5\text{ to }20\text{ V}$	-	35	-	$\mu\text{J}$

**Table 6. Switching times, based on HiP247 package option**

Symbol	Parameter	Test conditions	Min.	Typ.	Max.	Unit
$t_{d(on)}$	Turn-on delay time	$V_{DD} = 400\text{ V}$ , $I_D = 20\text{ A}$ , $R_G = 4.7\text{ }\Omega$ , $V_{GS} = -5\text{ to }20\text{ V}$	-	16	-	ns
$t_f$	Fall time		-	14	-	
$t_{d(off)}$	Turn-off delay time		-	35	-	
$t_r$	Rise time		-	9	-	

**Table 7. Reverse SiC diode characteristics**

Symbol	Parameter	Test conditions	Min.	Typ.	Max.	Unit
$V_{SD}$	Diode forward voltage	$I_F = 20\text{ A}$ , $V_{GS} = 0\text{ V}$	-	3.3	-	V
$t_{rr}$	Reverse recovery time	$V_{DD} = 400\text{ V}$ , $I_F = 20\text{ A}$ , $di/dt = 1000\text{ A}/\mu\text{s}$	-	18	-	ns
$Q_{rr}$	Reverse recovery charge		-	85	-	nC
$I_{RRM}$	Reverse recovery current		-	7	-	A

## 2.1 Electrical characteristics (curves), based on HiP247 package option

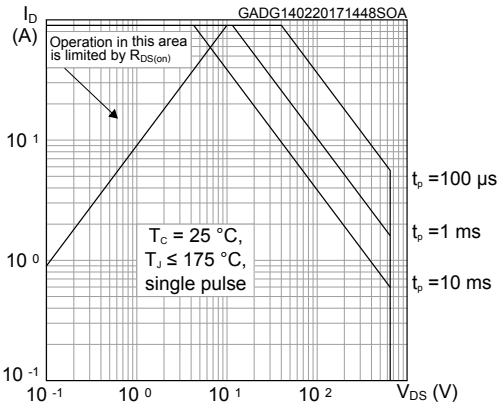
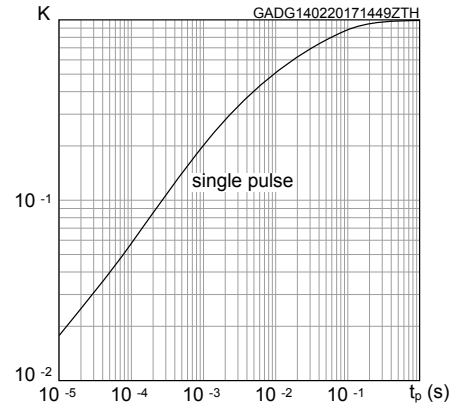
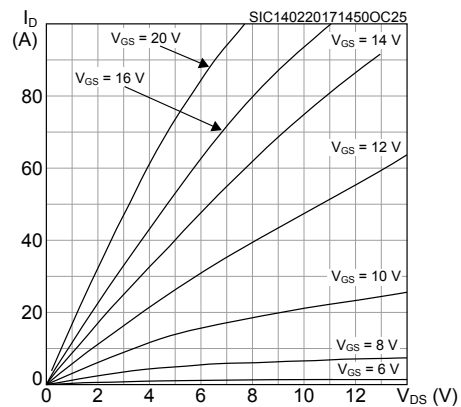
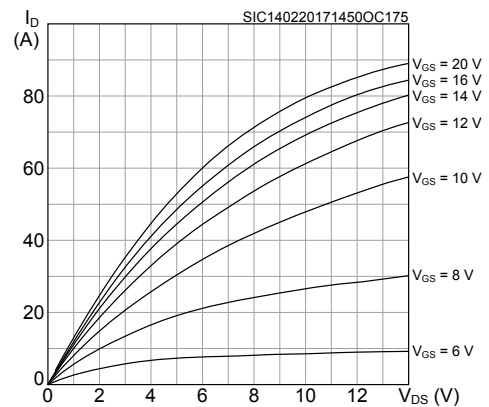
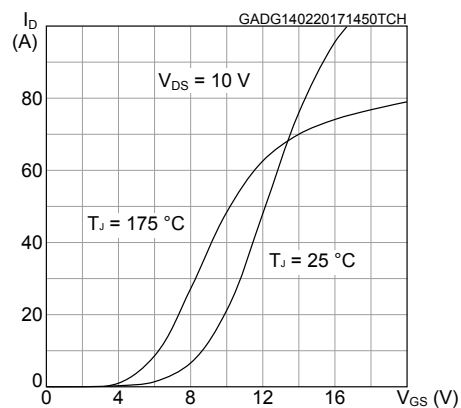
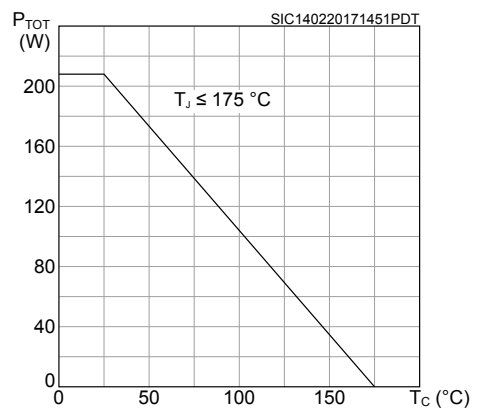
**Figure 1. Safe operating area**

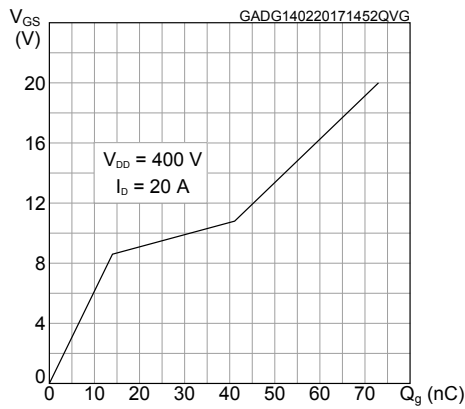
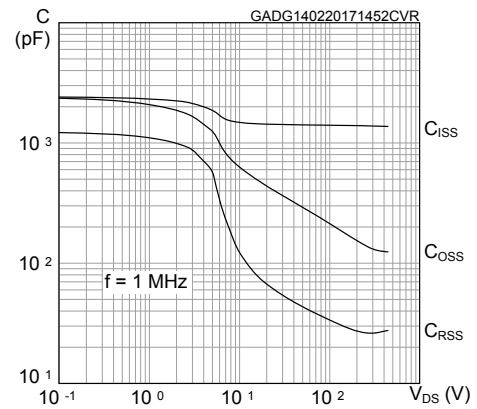
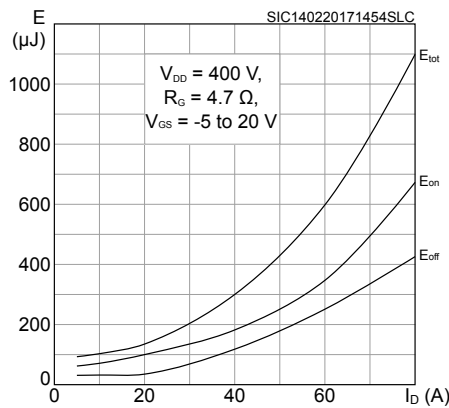
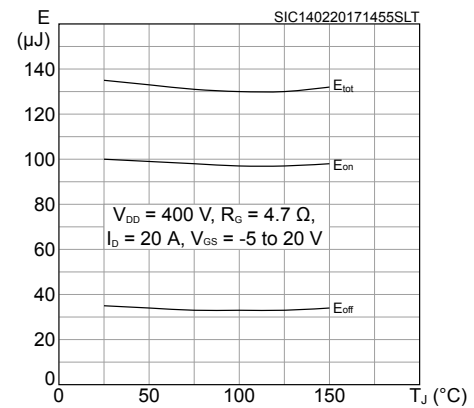
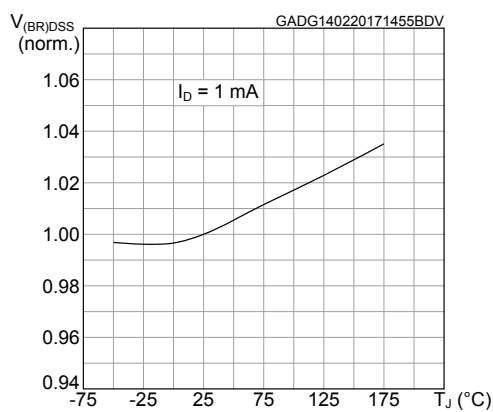
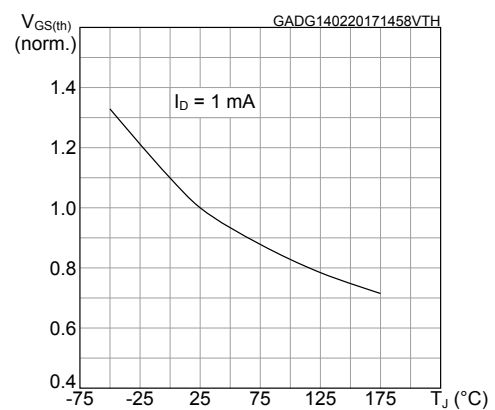
**Figure 2. Thermal impedance**

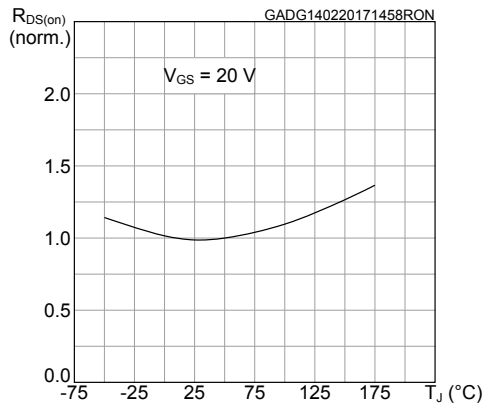
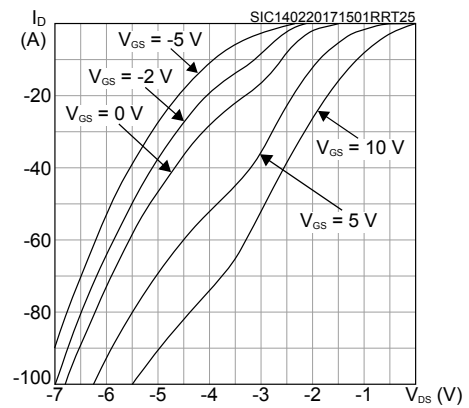
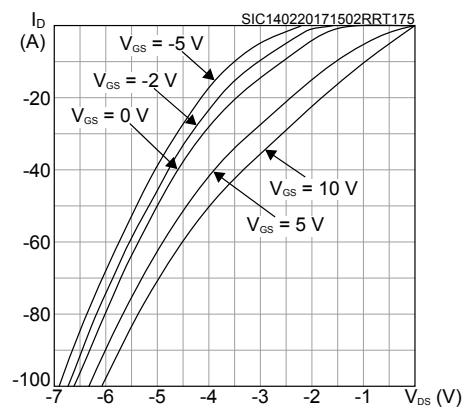
**Figure 3. Output characteristics ( $T_J = 25\text{ °C}$ )**

**Figure 4. Output characteristics ( $T_J = 175\text{ °C}$ )**

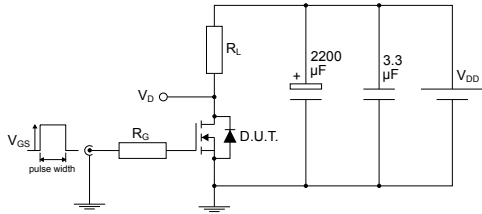
**Figure 5. Transfer characteristics**

**Figure 6. Total power dissipation**

**Figure 7. Gate charge vs gate-source voltage**

**Figure 8. Capacitance variations**

**Figure 9. Switching energy vs. drain current**

**Figure 10. Switching energy vs. junction temperature**

**Figure 11. Normalized  $V_{(BR)DSS}$  vs. temperature**

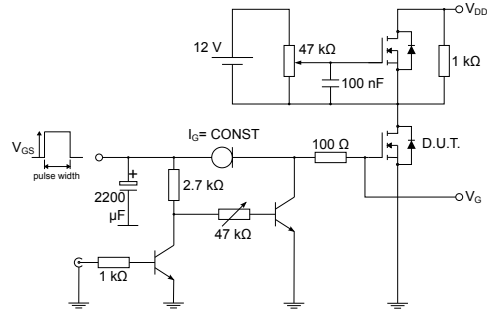
**Figure 12. Normalized gate threshold voltage vs. temperature**

**Figure 13. Normalized on-resistance vs. temperature**

**Figure 14. Reverse conduction characteristics ( $T_J = 25\text{ °C}$ )**

**Figure 15. Reverse conduction characteristics ( $T_J = 175\text{ °C}$ )**

### 3 Test circuits

**Figure 16. Test circuit for resistive load switching times**

AM01468v1

**Figure 17. Test circuit for gate charge behavior**

AM01469v1

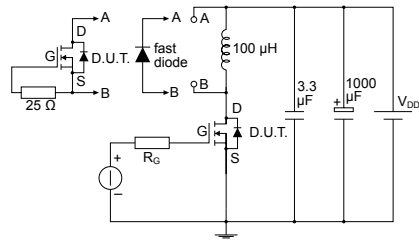
**Figure 18. Test circuit for inductive load switching and diode recovery times**

AM01470v1

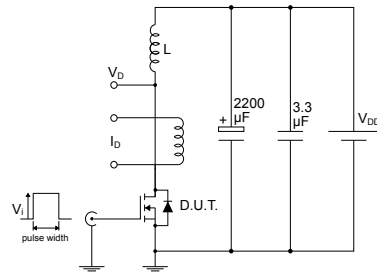
**Figure 19. Unclamped inductive load test circuit**

AM01471v1

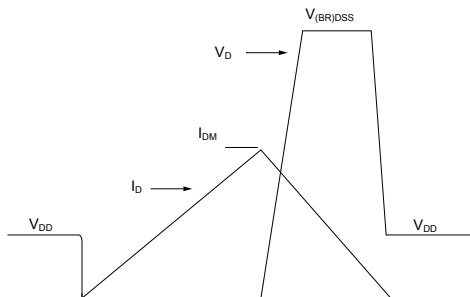
**Figure 20. Unclamped inductive waveform**

AM01472v1

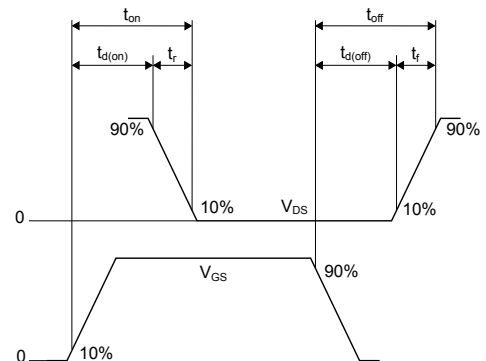
**Figure 21. Switching time waveform**

AM01473v1



## 4 Package information

In order to meet environmental requirements, ST offers these devices in different grades of **ECOPACK** packages, depending on their level of environmental compliance. ECOPACK specifications, grade definitions and product status are available at: [www.st.com](http://www.st.com). ECOPACK is an ST trademark.

### 4.1 H<sup>2</sup>PAK-7 package information

Figure 22. H<sup>2</sup>PAK-7 package outline

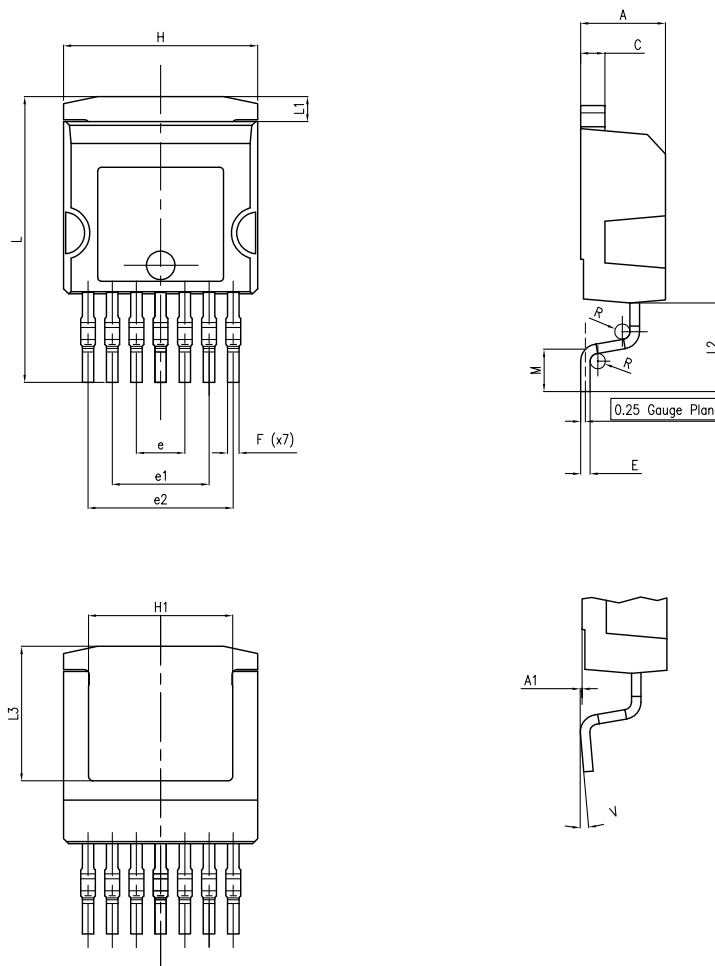

**Table 8. H<sup>2</sup>PAK-7 package mechanical data**

Dim.	mm	
	Min.	Max.
A	4.30	4.80
A1	0.03	0.20
C	1.17	1.37
e	2.34	2.74
e1	4.88	5.28
e2	7.42	7.82
E	0.45	0.60
F	0.50	0.70
H	10.00	10.40
H1	7.40	7.60
L	14.75	15.25
L1	1.27	1.40
L2	4.35	4.95
L3	6.85	7.25
M	1.90	2.50
R	0.20	0.60
V	0°	8°

**Figure 23. H<sup>2</sup>PAK-7 recommended footprint**

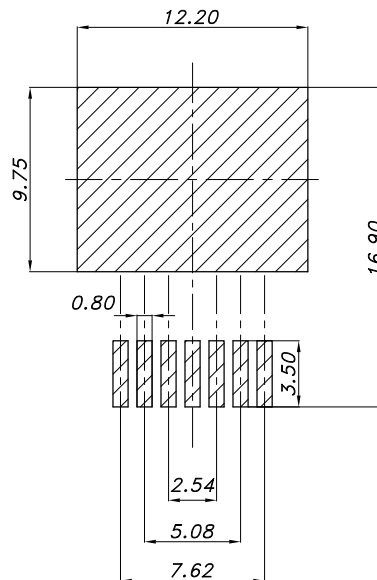

footprint\_DM00249216\_4

*Note: Dimensions are in mm.*

## 4.2 Packing information

Figure 24. Tape outline

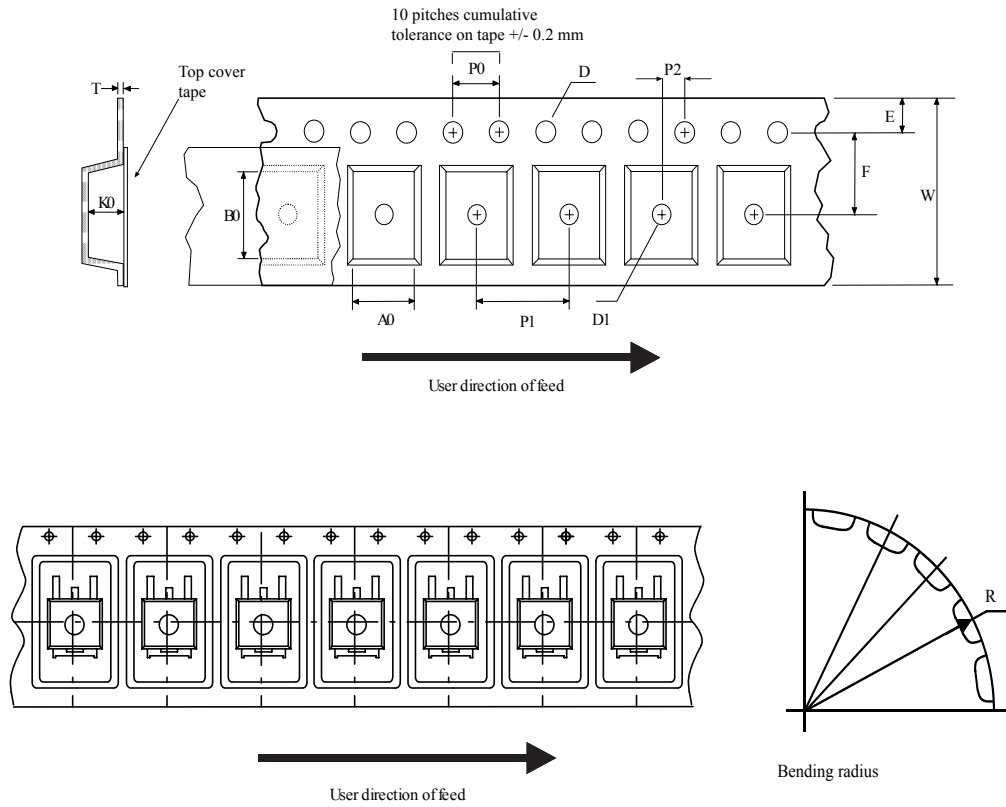

AM08852v2

Figure 25. Reel outline

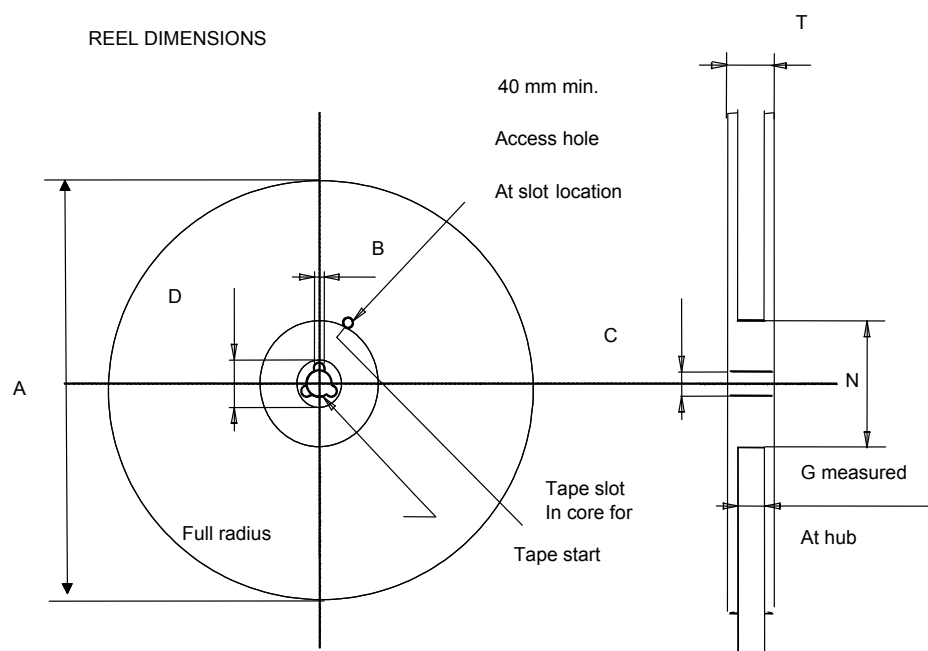

**Table 9. Tape and reel mechanical data**

Tape			Reel		
Dim.	mm		Dim.	mm	
	Min.	Max.		Min.	Max.
A0	10.5	10.7	A		330
B0	15.7	15.9	B	1.5	
D	1.5	1.6	C	12.8	13.2
D1	1.59	1.61	D	20.2	
E	1.65	1.85	G	24.4	26.4
F	11.4	11.6	N	100	
K0	4.8	5.0	T		30.4
P0	3.9	4.1			
P1	11.9	12.1	Base quantity		1000
P2	1.9	2.1	Bulk quantity		1000
R	50				
T	0.25	0.35			
W	23.7	24.3			

## Revision history

**Table 10. Document revision history**

Date	Version	Changes
17-Feb-2017	1	First release.
13-Dec-2017	2	Updated document title. Updated <i>Table 4: "On/off states"</i> . Minor text changes.
13-Dec-2018	3	Datasheet promoted from preliminary data to production data. Modified title and features on cover page. Minor text changes.
24-Jan-2020	4	Updated <a href="#">Table 1. Absolute maximum ratings</a> . Minor text changes.
11-Jan-2021	5	Updated <a href="#">Table 7. Reverse SiC diode characteristics</a> . Minor text changes.

---

## Contents

<b>1</b>	<b>Electrical ratings</b> .....	<b>2</b>
<b>2</b>	<b>Electrical characteristics</b> .....	<b>3</b>
<b>2.1</b>	Electrical characteristics (curves), based on HiP247 package option .....	<b>5</b>
<b>3</b>	<b>Test circuits</b> .....	<b>8</b>
<b>4</b>	<b>Package information</b> .....	<b>9</b>
<b>4.1</b>	H <sup>2</sup> PAK-7 package information .....	<b>9</b>
<b>4.2</b>	Packing information .....	<b>11</b>
	<b>Revision history</b> .....	<b>13</b>

**IMPORTANT NOTICE – PLEASE READ CAREFULLY**

STMicroelectronics NV and its subsidiaries (“ST”) reserve the right to make changes, corrections, enhancements, modifications, and improvements to ST products and/or to this document at any time without notice. Purchasers should obtain the latest relevant information on ST products before placing orders. ST products are sold pursuant to ST’s terms and conditions of sale in place at the time of order acknowledgement.

Purchasers are solely responsible for the choice, selection, and use of ST products and ST assumes no liability for application assistance or the design of Purchasers’ products.

No license, express or implied, to any intellectual property right is granted by ST herein.

Resale of ST products with provisions different from the information set forth herein shall void any warranty granted by ST for such product.

ST and the ST logo are trademarks of ST. For additional information about ST trademarks, please refer to [www.st.com/trademarks](http://www.st.com/trademarks). All other product or service names are the property of their respective owners.

Information in this document supersedes and replaces information previously supplied in any prior versions of this document.

© 2021 STMicroelectronics – All rights reserved