

Alle Rechte vorbehalten/ All rights reserved

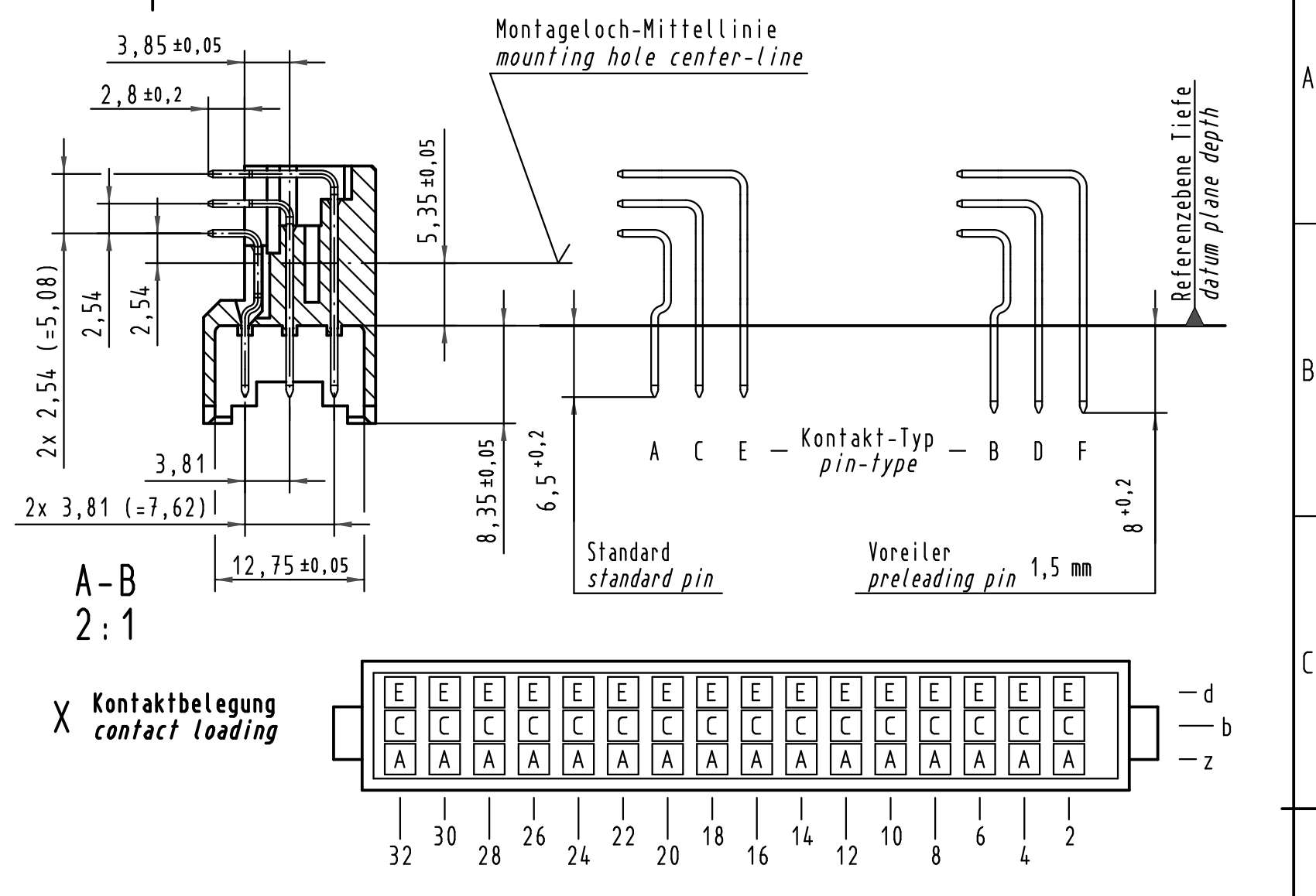
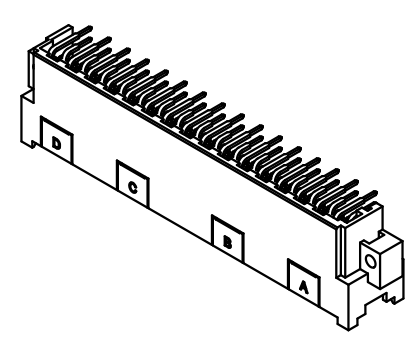
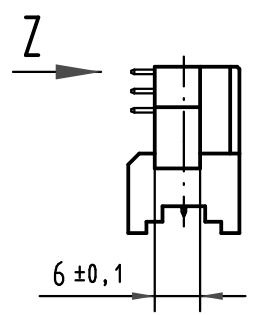
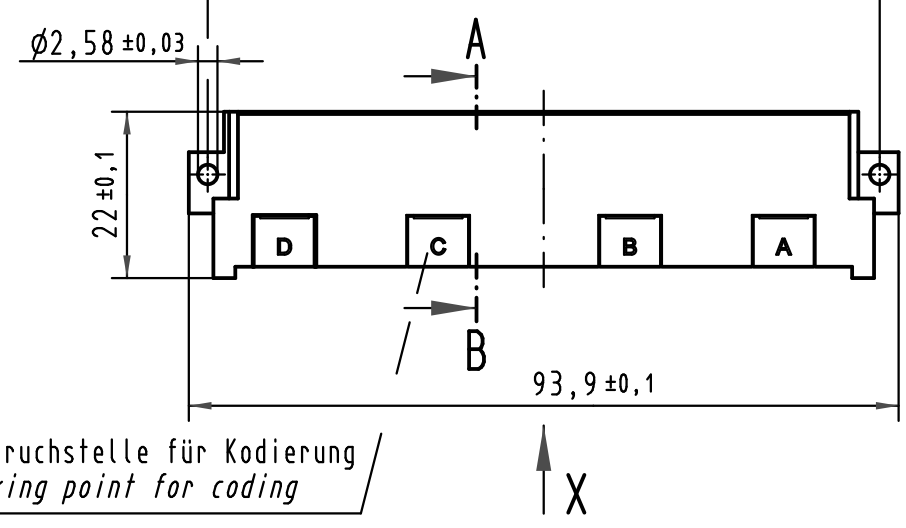
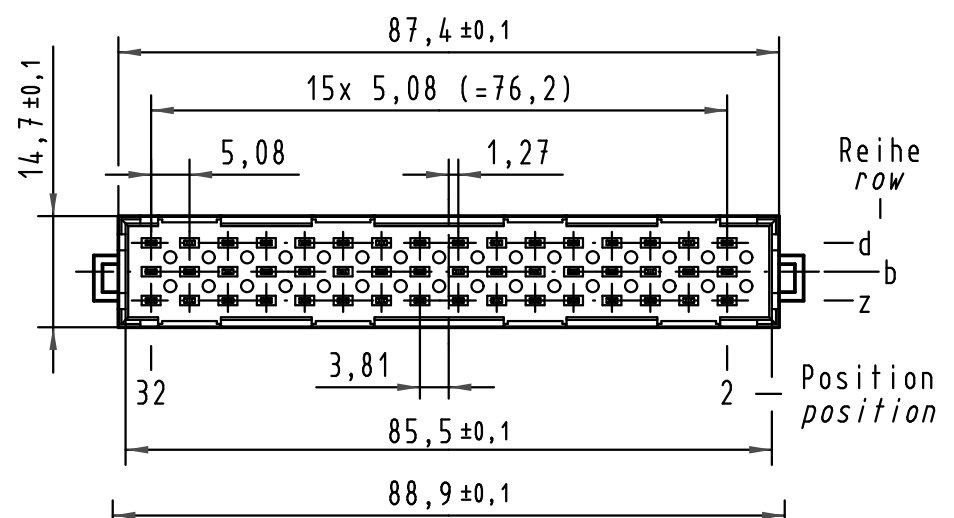
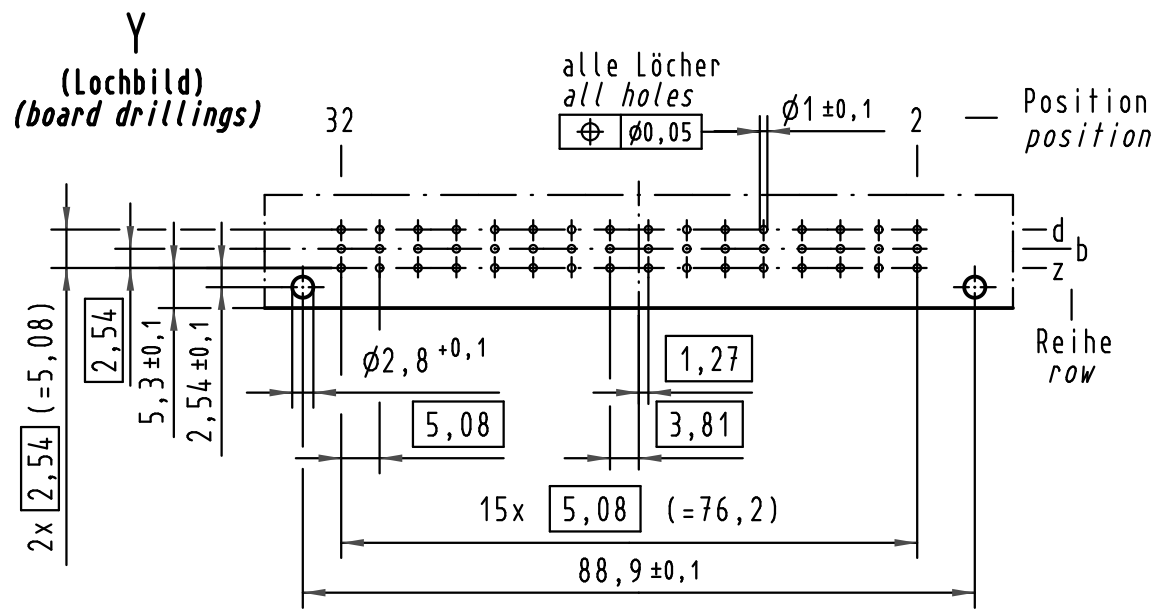

09 06 148 6901 840	2	Au flash over PdNi over Ni
09 06 148 2901 840	1	Au flash over PdNi over Ni
Bestell-Nr. part-no.	Anforderungsstufe nach IEC performance level acc. to IEC	Kontaktoberfläche contact plating

Z 10:1

Querschnitt der Lötanschlüsse:
cross-section of solder terminations:

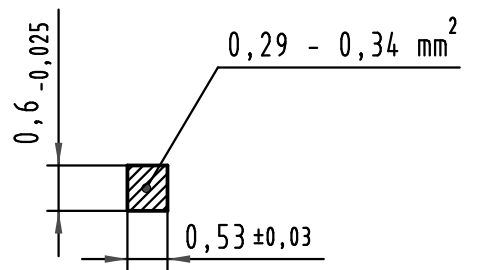

All Dimensions in mm Original Size DIN A 3		Techn. Character.		Nicht tolerierte Maßel Free size tolerances IEC 60603-2	
		Dat.	Name	Maßstab/Scale	
		Detail.	09.11.05 Hage.	1:1 (2:1; 10:1)	
		Insp.	09.11.05 Ge.		
		Stand.			
35260	08.09.08	Hage.	HARTING Electronics GmbH & Co. KG		TB 09 06 148 x901 840
33192			D-32339 ESPELKAMP		
Mod.	Dat.	Name	Sub.		Blatt/ page

Mouser Electronics

Authorized Distributor

Click to View Pricing, Inventory, Delivery & Lifecycle Information:

HARTING:

[09061482901840](#) [09061486901840](#)