

# LTF Time of Flight Laser Distance Sensor Quick Start Guide

## Product Description

Laser distance sensor with both analog and discrete (switched) outputs

This guide is designed to help you set up and install the LTF Time of Flight Laser Distance Sensor. For complete information on programming, performance, troubleshooting, dimensions, and accessories, please refer to the Instruction Manual at [www.bannerengineering.com](http://www.bannerengineering.com). Search for p/n 194135 to view the manual. Use of this document assumes familiarity with pertinent industry standards and practices.



### WARNING

#### DO NOT USE THIS DEVICE FOR PERSONNEL PROTECTION

Using this device for personnel protection could result in serious injury or death.

- This device does not include the self-checking redundant circuitry necessary to allow its use in personnel safety applications. A device failure or malfunction can cause either an energized (on) or de-energized (off) output condition.

## Features and Indicators

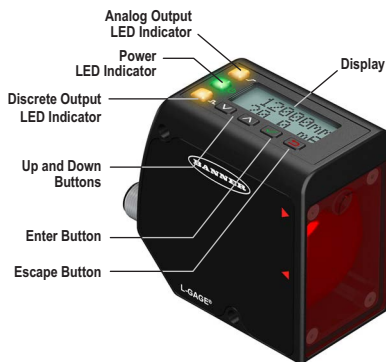

Figure 1: Features

Three LED indicators provide an ongoing indication of the sensing status.

#### Analog Output LED Indicator

- Solid Amber = Displayed distance is within the taught analog output window
- Off = Displayed distance is outside the taught analog output window

#### Power LED Indicator

- Solid Green = Normal operation, power On and laser On
- Flashing Green (1 Hz) = Power On and laser Off (laser enable mode)

#### Discrete Output LED Indicator

- Solid Amber = Discrete Output is On
- Off = Discrete Output is Off

## Display



Figure 2: shown in Run Mode

The display is a 2-line, 8-character LCD. The main screen is the Run mode screen, which shows the real-time distance measurement and the analog output measurement.

## Buttons and Icons

Use the sensor buttons **Down**, **Up**, **Enter**, and **Escape** to program the sensor and to access sensor information.



#### Down and Up Buttons

Press **Down** and **Up** to:

- Access the Quick Menu from Run mode
- Navigate the menu systems
- Change programming settings
- Change individual digit values in distance based settings

When navigating the menu systems, the menu items loop.

**Enter Button**Press **Enter** to:

- Access the Sensor Menu from Run mode
- Access the submenus
- Move right one digit in distance based settings
- Save changes

In the Sensor Menu, a checkmark "✓" in the lower right corner of the display indicates that pressing **Enter** accesses a submenu. Press **Enter** to save changes. New values flash rapidly and the sensor returns to the parent menu.

**Escape Button**Press **Escape** to:

- Leave the current menu and return to the parent menu
- Return to Run mode from the Quick Menu

**IMPORTANT:** Pressing **Escape** discards any unsaved programming changes.

In the Sensor Menu, a return arrow in the upper left corner of the display indicates that pressing **Escape** returns to the parent menu. Press and hold **Escape** for 2 seconds to return to Run mode from any menu or remote teach.



A lock symbol displays in the upper left corner of the display to indicate when the sensor is locked.

## Laser Description and Safety Information

**CAUTION****RETURN DEFECTIVE UNITS TO THE MANUFACTURER.**

Use of controls or adjustments or performance of procedures other than those specified herein may result in hazardous radiation exposure.

- Do not attempt to disassemble this sensor for repair. A defective unit must be returned to the manufacturer.

## Class 2 Laser Models

**CAUTION****NEVER STARE DIRECTLY INTO THE SENSOR LENS.**

Laser light can damage your eyes.

- Avoid placing any mirror-like object in the beam. Never use a mirror as a retroreflective target.

**For Safe Laser Use - Class 2 Lasers**

- Do not stare at the laser.
- Do not point the laser at a person's eye.
- Mount open laser beam paths either above or below eye level, where practical.
- Terminate the beam emitted by the laser product at the end of its useful path.

Reference IEC 60825-1:2007, Section 8.2.

**Class 2 Lasers**

Class 2 lasers are lasers that emit visible radiation in the wavelength range from 400 nm to 700 nm, where eye protection is normally afforded by aversion responses, including the blink reflex. This reaction may be expected to provide adequate protection under reasonably foreseeable conditions of operation, including the use of optical instruments for intrabeam viewing.

**Class 2 Laser Safety Notes**

Low-power lasers are, by definition, incapable of causing eye injury within the duration of a blink (aversion response) of 0.25 seconds. They also must emit only visible wavelengths (400 to 700 nm). Therefore, an ocular hazard may exist only if individuals overcome their natural aversion to bright light and stare directly into the laser beam.



Figure 3: FDA (CDRH) warning label (Class 2)

## Sensor Installation

*NOTE: Handle the sensor with care during installation and operation. Sensor windows soiled by fingerprints, dust, water, oil, etc. may create stray light that may degrade the peak performance of the sensor. Blow the window clear using filtered, compressed air, then clean as necessary using 70% isopropyl alcohol and cotton swabs or water and a soft cloth.*

### Mount the Device

1. If a bracket is needed, mount the device onto the bracket.
2. Mount the device (or the device and the bracket) to the machine or equipment at the desired location. Do not tighten the mounting screws at this time.
3. Check the device alignment.
4. Tighten the mounting screws to secure the device (or the device and the bracket) in the aligned position.

## Wiring Diagrams

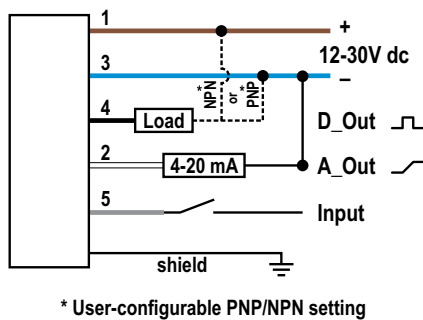

Figure 4: Analog Current Model

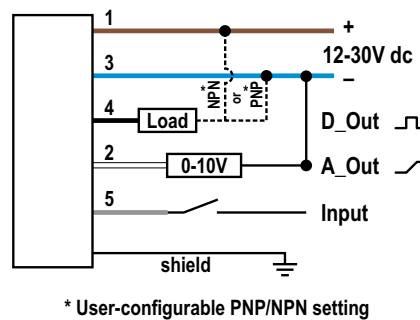
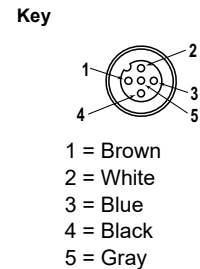

Figure 5: Analog Voltage Model



## Sensor Programming

Program the sensor using the buttons on the sensor or the remote input (limited programming options).

From Run mode, use the buttons to access the Quick Menu and the Sensor Menu. See [Quick Menu on page 4](#), and the instruction manual (p/n 194135) for more information on the options available from each menu. For TEACH options, follow the TEACH instructions in the instruction manual.

In addition to programming the sensor, use the remote input to disable the buttons for security, preventing unauthorized or accidental programming changes. See the instruction manual for more information.

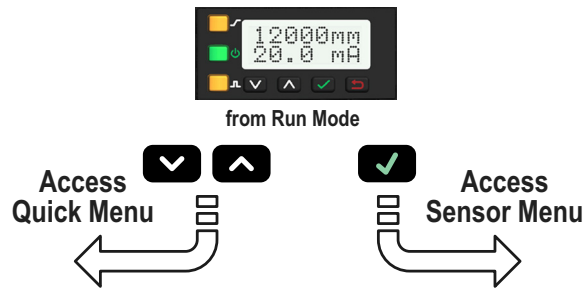

Figure 6: Accessing the menus

See [Quick Menu on page 4](#)

See

### Quick Menu

The sensor includes a Quick Menu with easy access to view and change the analog and discrete output switch points. Access the Quick Menu by pressing **Down** or **Up** from Run mode. When in the Quick Menu, the current distance measurement displays on the first line and the menu name and the analog value alternate on the second line of the display. Press **Enter** to access the switch points. Press **Down** and **Up** to change each digit. Press **Enter** to move right one digit. After reviewing each digit, press **Enter** again to save the new value and return to the Quick Menu. Press **Cancel** to ignore any changes made if only some digits have been changed.

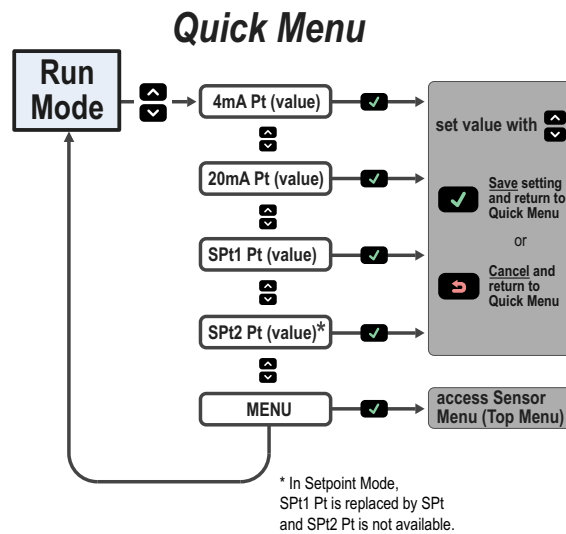

Figure 7: Quick Menu Map (Window Mode)

### LTF Sensor Menu (MENU)

Access the Sensor Menu by pressing **Enter** from Run mode. The Sensor Menu is also accessible from the Quick Menu: navigate to **MENU** and press **Enter**. The Sensor Menu includes several submenus that provide access to view and change sensor settings and to view sensor information.

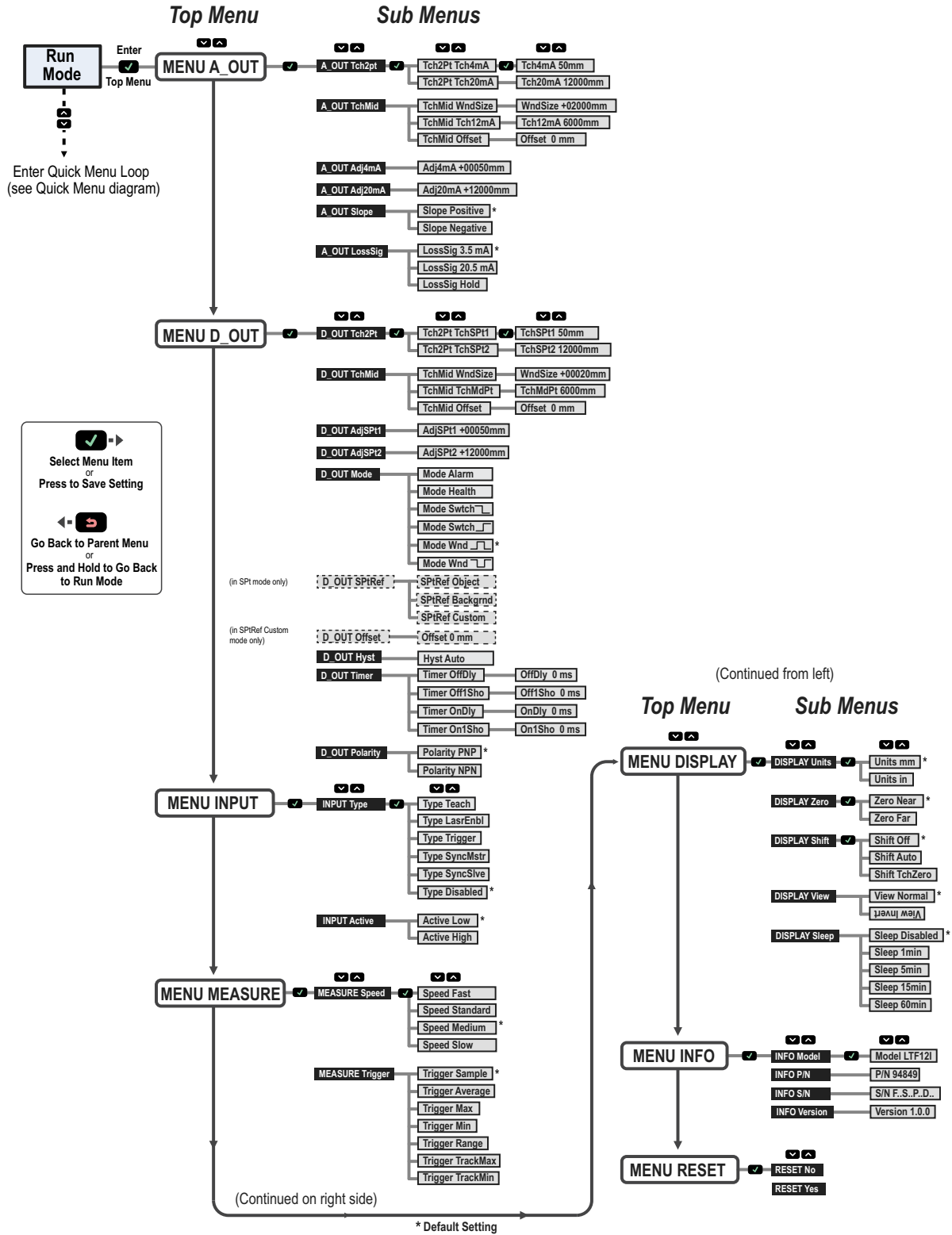

Figure 8: Sensor Menu Map

## Specifications for the LTF Sensor

### Supply Voltage

12 V DC to 30 V DC

### Power and Current Consumption (Exclusive of Load)

Normal Run Mode: < 2.1 W

Current consumption < 85 mA at 24 V DC

### Supply Protection Circuitry

Protected against reverse polarity and transient overvoltages

### Construction

Die-cast zinc housing; acrylic window

### Maximum Torque

2.6 N·m (23.0 in-lbs)

### Sensing Beam

Visible red, 660 nm

### Output Configuration

Analog output: 4 to 20 mA or 0 to 10 V, depending on model

Discrete output rating: Discrete NPN/PNP is user-configurable

### Output Ratings

Discrete Output: 100 mA maximum (protected against continuous overload and short circuit)

OFF-state leakage current (PNP): < 10  $\mu$ A at 30 V

OFF-state leakage current (NPN): < 200  $\mu$ A at 30 V

Output saturation voltage (PNP outputs): < 3 V at 100 mA

Output saturation voltage (NPN outputs): < 1.6 V at 100 mA

Analog current output (LTF...I Models): 1 k $\Omega$  maximum at 24 V; maximum load resistance =  $[(V_{CC}-4.5)/0.02 \Omega]$

Analog voltage output (LTF...U Models): 2.5 k $\Omega$  minimum load resistance

### Remote Input

Allowable Input Voltage Range: 0 to  $V_{CC}$

Active Low (internal weak pullup—sinking current): High State > 4.3 V at 740  $\mu$ A maximum; Low State < 1.3 V at 800  $\mu$ A maximum

Active High (internal weak pulldown—sourcing current): High State > 4.3 V at 1.7 mA maximum; Low State < 1.3 V at 1.6 mA maximum

### Storage Conditions

-30 °C to +65 °C (-22 °F to +149 °F)

### Operating Conditions

-20 °C to +55 °C (-4 °F to +131°F)

90% at +55 °C maximum relative humidity (non-condensing)

### Shock

MIL-STD-202G, Method 213B, Condition I (100G 6x along X, Y, and Z axes, 18 shocks), with device operating

### Sensing Range -- LTF12

90% White Target: 50 mm to 12000 mm

18% Gray Target: 50 mm to 11000 mm

6% Black Target: 50 mm to 7000 mm

### Sensing Range -- LTF24

90% White Target: 50 mm to 24000 mm

18% Gray Target: 50 mm to 18000 mm

6% Black Target: 50 mm to 11000 mm

### Ambient Light Immunity

> 40000 lux

### Delay at Power Up

2 seconds

### Measurement Output Rate

0.5 ms

### Minimum Window Size, Analog and Discrete

10 mm

### Boresighting

100 mm radius at 12000 mm

### Temperature Effect

50 mm to 12000 mm:  $\pm 0.25$  mm/°C (typical)

>12000 mm:  $\pm 0.5$  mm/°C (typical)

### Resolution

LTF12: < 0.3 mm to 3 mm

LTF24: < 0.3 mm to 4 mm

Resolution measured as twice repeatability with white target at slow response speed at 20 °C. See repeatability curves for more detail.

### Beam Spot Size

6.5 mm at 50 mm

10 mm at 7500 mm

12.5 mm at 12000 mm

35 mm at 24000 mm

Beam spot size is calculated as 1.6 times the D4 $\sigma$  measured diameter

### Response Time

Fast: 1.5 ms

Standard: 8 ms

Medium: 32 ms

Slow: 256 ms

### Repeatability

See Performance Curves

### Environmental Rating

IP67; NEMA 6

### Vibration

MIL-STD-202G, Method 201A (Vibration: 10 Hz to 55 Hz, 0.06 inch (1.52 mm) double amplitude, 2 hours each along X, Y and Z axes), with device operating

### Application Note

For optimum performance, allow 15 minutes for the sensor to warm up

### Certifications



Banner Engineering BV  
Park Lane, Culliganlaan 2F  
bus 3, 1831 Diegem,  
BELGIUM



Turck Banner LTD Blenheim  
House, Blenheim Court,  
Wickford, Essex SS11 8YT,  
Great Britain



### Linearity/Accuracy

Reflectance	LTF12		LTF24		
	±10 mm	±25 mm	±25 mm	±50 mm	±100 mm
6% Black Card	4 m	7 m	7 m	8 m	11 m
18% Gray Card	7 m	11 m	11 m	13 m	18 m
90% White Card	12 m	-	24 m	-	-

**Required Overcurrent Protection**

**WARNING:** Electrical connections must be made by qualified personnel in accordance with local and national electrical codes and regulations.

Overcurrent protection is required to be provided by end product application per the supplied table. Overcurrent protection may be provided with external fusing or via Current Limiting, Class 2 Power Supply. Supply wiring leads < 24 AWG shall not be spliced. For additional product support, go to [www.bannerengineering.com](http://www.bannerengineering.com).

Supply Wiring (AWG)	Required Overcurrent Protection (A)	Supply Wiring (AWG)	Required Overcurrent Protection (A)
20	5.0	26	1.0
22	3.0	28	0.8
24	1.0	30	0.5

**Repeatability Performance**

**LTF12 Models**

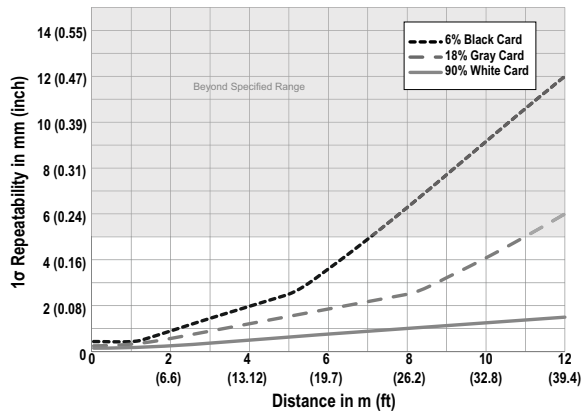

Figure 9: Speed: Slow (256 ms)

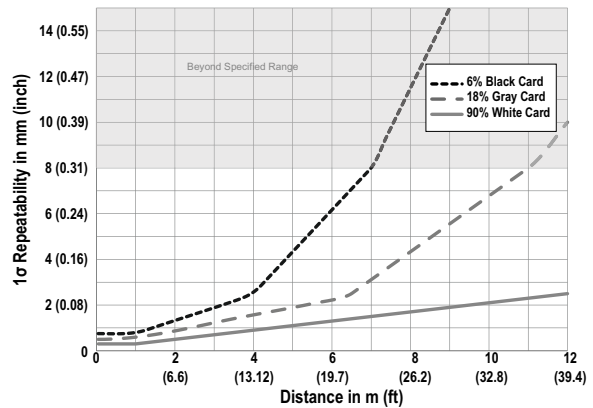

Figure 10: Speed: Medium (32 ms)

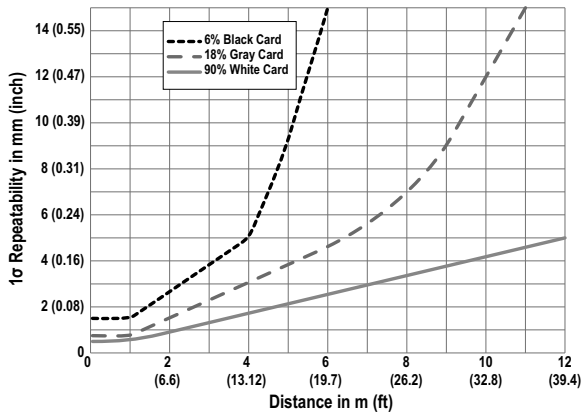

Figure 11: Speed: Standard (8 ms)

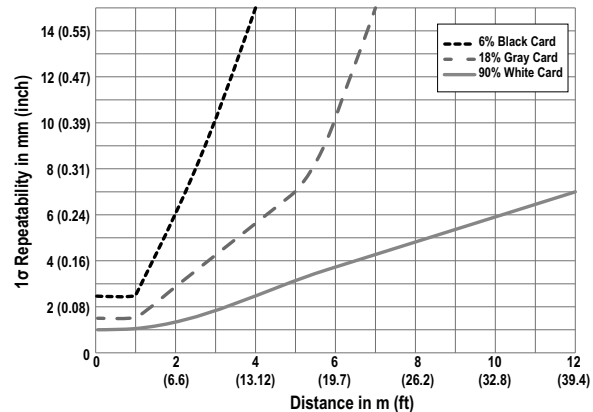

Figure 12: Speed: Fast (1.5 ms)

LTF24 Models

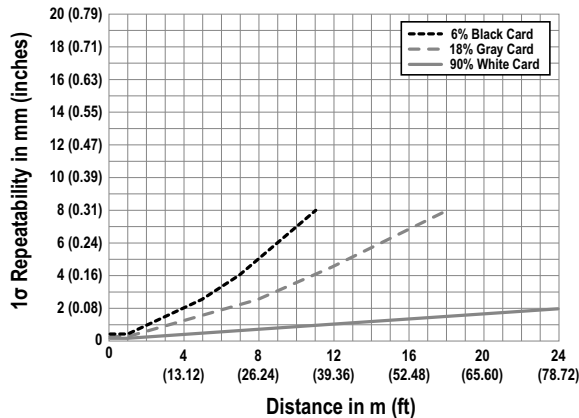

Figure 13: Speed: Slow (256 ms)

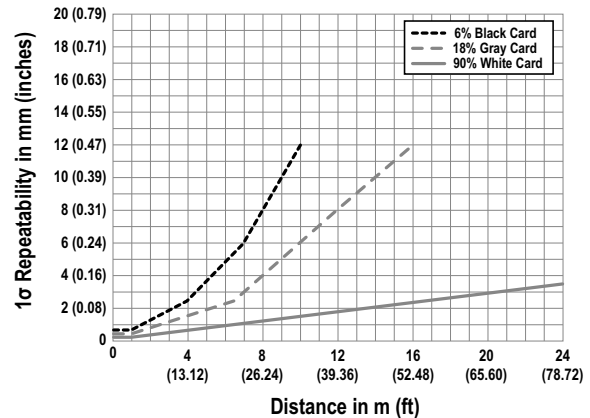

Figure 14: Speed: Medium (32 ms)

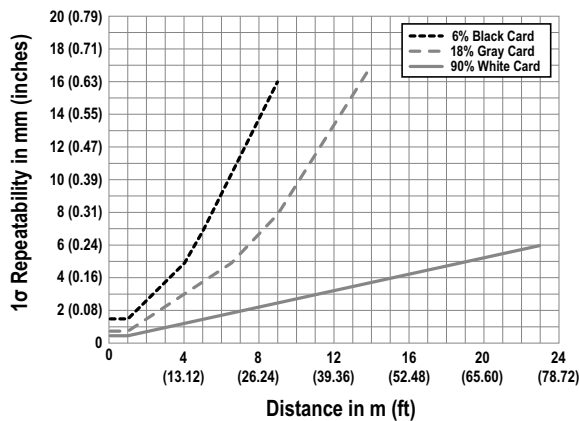

Figure 15: Speed: Standard (8 ms)

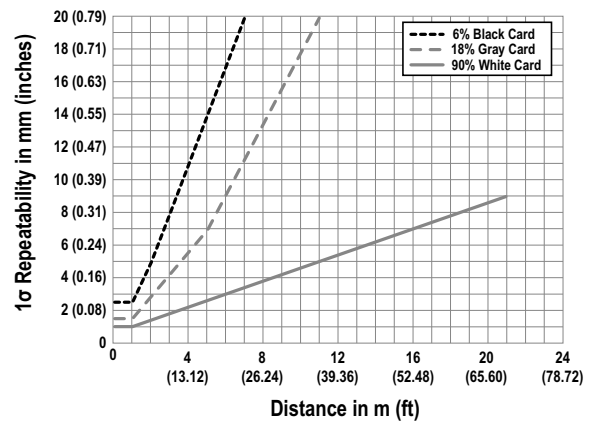

Figure 16: Speed: Fast (1.5 ms)

## Banner Engineering Corp Limited Warranty

Banner Engineering Corp. warrants its products to be free from defects in material and workmanship for one year following the date of shipment. Banner Engineering Corp. will repair or replace, free of charge, any product of its manufacture which, at the time it is returned to the factory, is found to have been defective during the warranty period. This warranty does not cover damage or liability for misuse, abuse, or the improper application or installation of the Banner product.

**THIS LIMITED WARRANTY IS EXCLUSIVE AND IN LIEU OF ALL OTHER WARRANTIES WHETHER EXPRESS OR IMPLIED (INCLUDING, WITHOUT LIMITATION, ANY WARRANTY OF MERCHANTABILITY OR FITNESS FOR A PARTICULAR PURPOSE), AND WHETHER ARISING UNDER COURSE OF PERFORMANCE, COURSE OF DEALING OR TRADE USAGE.**

This Warranty is exclusive and limited to repair or, at the discretion of Banner Engineering Corp., replacement. **IN NO EVENT SHALL BANNER ENGINEERING CORP. BE LIABLE TO BUYER OR ANY OTHER PERSON OR ENTITY FOR ANY EXTRA COSTS, EXPENSES, LOSSES, LOSS OF PROFITS, OR ANY INCIDENTAL, CONSEQUENTIAL OR SPECIAL DAMAGES RESULTING FROM ANY PRODUCT DEFECT OR FROM THE USE OR INABILITY TO USE THE PRODUCT, WHETHER ARISING IN CONTRACT OR WARRANTY, STATUTE, TORT, STRICT LIABILITY, NEGLIGENCE, OR OTHERWISE.**

Banner Engineering Corp. reserves the right to change, modify or improve the design of the product without assuming any obligations or liabilities relating to any product previously manufactured by Banner Engineering Corp. Any misuse, abuse, or improper application or installation of this product or use of the product for personal protection applications when the product is identified as not intended for such purposes will void the product warranty. Any modifications to this product without prior express approval by Banner Engineering Corp will void the product warranties. All specifications published in this document are subject to change; Banner reserves the right to modify product specifications or update documentation at any time. Specifications and product information in English supersede that which is provided in any other language. For the most recent version of any documentation, refer to: [www.bannerengineering.com](http://www.bannerengineering.com).

For patent information, see [www.bannerengineering.com/patents](http://www.bannerengineering.com/patents).



Document title: LTF Time of Flight Laser Distance Quick Start Guide

Part number: 194136

Revision: F

Original Instructions

© Banner Engineering Corp. All rights reserved.

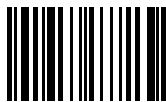

194136

# Mouser Electronics

Authorized Distributor

Click to View Pricing, Inventory, Delivery & Lifecycle Information:

## [Banner Engineering:](#)

[LTF12IC2LD W/30](#) [LTF12IC2LDQ](#) [LTF12IC2LD](#) [LTF12IC2LDQP](#) [LTF12UC2LD](#) [LTF12UC2LD W/30](#)  
[LTF12UC2LDQ](#) [LTF12UC2LDQP](#) [LTF24IC2LD](#) [LTF24IC2LD W/30](#) [LTF24IC2LDQ](#) [LTF24IC2LDQP](#) [LTF24UC2LD](#)  
[LTF24UC2LD W/30](#) [LTF24UC2LDQ](#) [LTF24UC2LDQP](#)